

Service

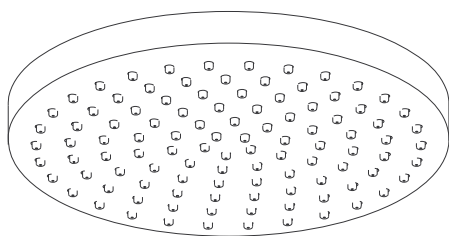

Tellerkopfbrause head shower
21 970 xxx

PHARO[®]
hansgrohe

DD 500/600

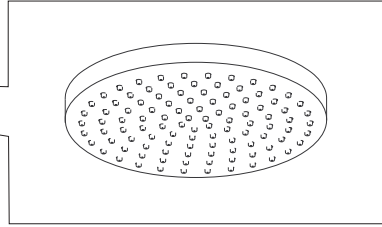
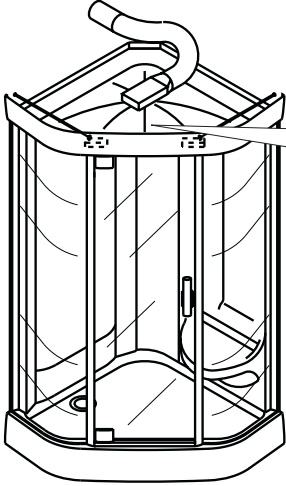

Seite 3
Page 3

DT 90/100

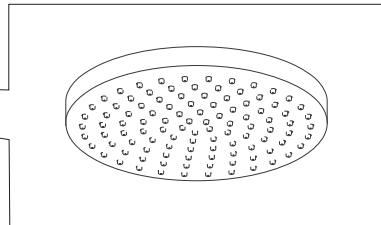
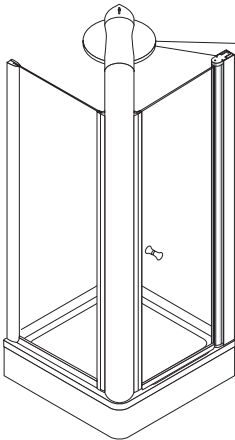

Seite 4
Page 4

1

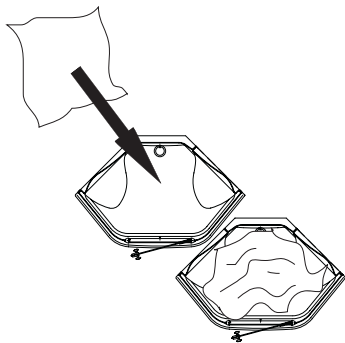
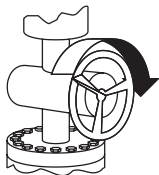
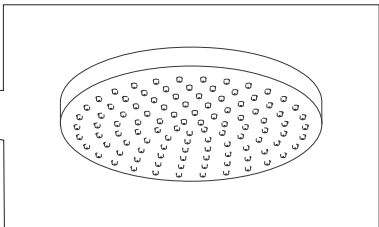
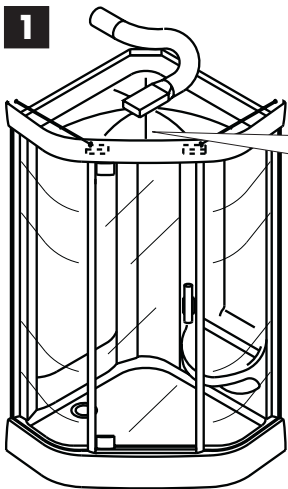

3

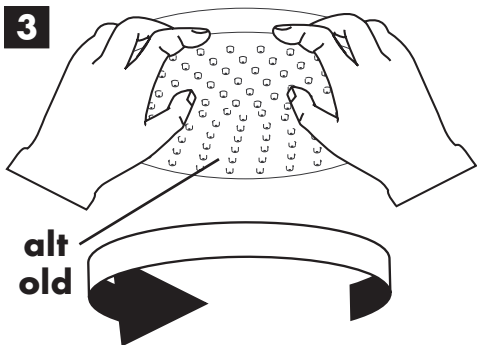

alt
old

4

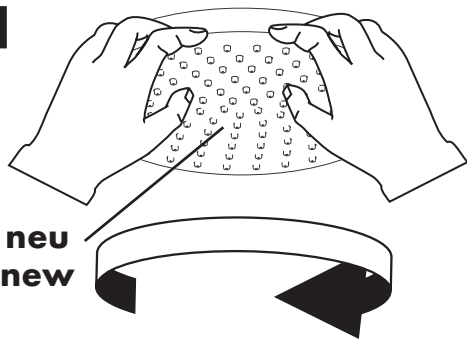

neu
new

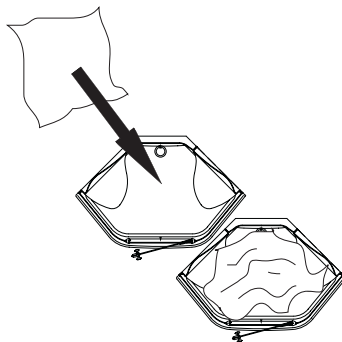
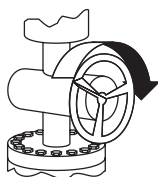
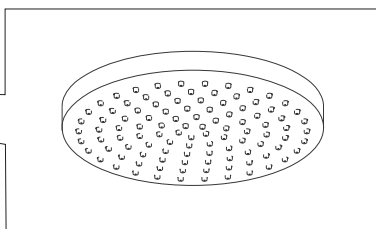
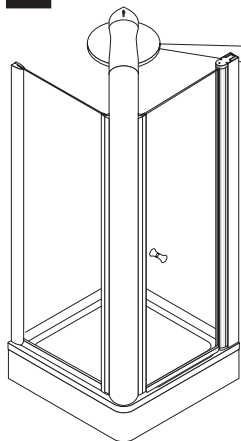
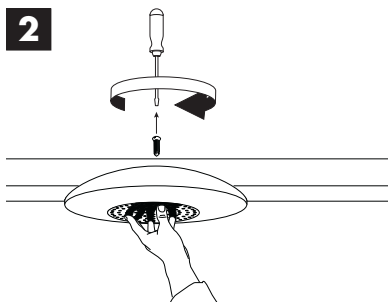
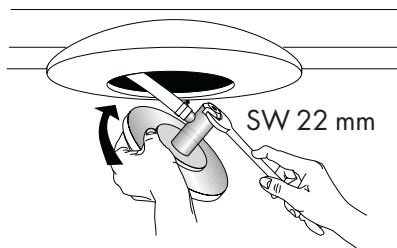
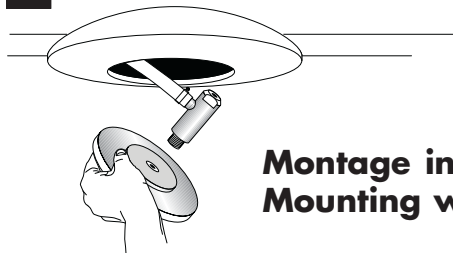
1**2****3****4**

**Montage in umgekehrter Reihenfolge!
Mounting will happen in the opposite order!**

hansgrohe

AXOR | PHÄRO

Hansgrohe · Postfach 1145 · D-77761 Schiltach · Telefon +49 (0) 78 36/51-1282 · Telefax +49 (0) 7836/511440
E-Mail: info@hansgrohe.com · Internet: www.hansgrohe.com

08/2004
9.09421.01