

# Montageanleitung

Installation Instructions  
Istruzioni di montaggio

## Aquafun



**Aquafun 95 Shower** 21109000

**Aquafun 95 Steam** 21119000

**Aquafun 95 Comfort** 21113000

**Aquafun 95 Deluxe** 21129000

**PHARO**<sup>®</sup>  
hansgrohe

Deutsch



English

Italiano

<b>Deutsch</b>		<b>English</b>	
Vorwort/Anschlussmaße	4	Preface/Connection Dimensions	4
Ausstattung	6	Equipment	6
Serviceteile	8	Serviceteile	8
Sicherheitshinweis	10	Safety Instructions	10
Checkliste	14	Check List	14
Benötigte Werkzeuge	16	Required Tools	16
Einstellung Wannenfüße/Ausrichtung Duschwanne	18	Adjusting the Tray Feet/Positioning the Shower Tray	18
Seitenverkleidung abnehmen	20	Removing the Side Casing	20
Montage Rückwand	22	Installing the Rear Panel	22
Vorbereitung Montage Trägerrahmen	24	Preparing the Support Frame Installation	24
Vorbereitung Montage Trägerrahmen	26	Preparing the Support Frame Installation	26
Vorbereitung Montage Trägerrahmen	28	Preparing the Support Frame Installation	28
Schiebetür einbauen/einstellen	30	Installing/Adjusting the Slide Door	30
Erdungsmaßnahme/Stromversorgung	32	Earthing Measure/Power Supply	32
Montage obere Abdeckung	34	Installing the Top Cover	34
Anschluss Beleuchtung/Lautsprecher	36	Connecting the Illumination/Loudspeaker	36
Montage Verbindungsschläuche/Kopfbrause	38	Installing the Connection Tubes/Head Shower	38
Montage Wasseranschlüsse	40	Installing the Water Connections	40
Montage Dampfdusche/Dachabdeckung/Seitenverkleidung	42	Installing the Steam Shower/Roof Cover/Side Casing	42
Schiebetür einstellen	44	Adjusting the Slide Door	44
Montage Schlauch/Handbrause	46	Installing the Tube/Hand Shower	46
Thermostat einstellen/warten	48	Setting/Serviceing the Thermostat	48
Brausenfunktionen	50	Shower Functions	50
Bedienelement (Steam)	54	Operating Element (Steam)	54
Elektronisches Bedienelement	56	Electronic Operating Element	56
Wartung/Störungen und Abhilfen	74	Maintenance/Failures and Rectifications	74
Adressen	78	Addresses	78

**Italiano**

Introduzione/quote di collegamento	4
Equipaggiamento	6
Parti Di Ricambio	8
Norme di sicurezza	10
Elenco di controllo	14
Attrezzi necessari	16
Regolazione dei piedi della vasca / posizionamento della vasca della doccia	18
Smontaggio del pannello laterale	20
Montaggio del pannello posteriore	22
Preparativi per il montaggio del telaio	24
Preparativi per il montaggio del telaio	26
Preparativi per il montaggio del telaio	28
Montaggio/regolazione della porta scorrevole	30
Messa a terra / alimentazione elettrica	32
Montaggio della copertura superiore	34
Collegamento dell'illuminazione / altoparlante	36
Montaggio dei tubi flessibili di raccordo / doccia di testa	38
Montaggio dei raccordi idraulici	40
Montaggio della doccia a vapore / copertura del tetto / pannello laterale	42
Regolazione della porta scorrevole	44
Montaggio del tubo flessibile / doccia manuale	46
Regolazione / manutenzione del termostato	48
Funzioni della doccia	50
Funzionamento (bagno di vapore)	54
Elemento di comando elettronico	56
Manutenzione / anomalie e rimedi	74
Indirizzi	78

Deutsch	English	Italiano
<p>Die Montageanleitung enthält die wichtigsten Montageschritte und Installationshinweise für die auf der Titelseite bezeichneten Produkte. Lesen Sie die Montageanleitung aufmerksam, um Montagefehler zu vermeiden. Die Dampfdusche wurde nach den geltenden Richtlinien hergestellt. Unsachgemäße Montage kann zu Verletzungen führen!</p> <p><b>Information</b></p> <p>Die Dampfdusche wurde konform mit den Niederspannungsrichtlinien 73/23/EWG, 93/68 EWG und der Norm CEI 64-8 (IEC 364) hergestellt. Die Schutzart der Dampfdusche ist IPX4, die Nennspannung ist 230 V, die Nennleistung ist 2400 W für die Ausführung Steam und Deluxe.</p> <p>Die von der "Europarichtlinie" für elektromagnetische Verträglichkeit auferlegten Sicherheitsanforderungen (Richtlinie 89/336/EWG, 92/31/EWG, 93/68/EWG) und die Konformität wird durch die Anwendung folgender europäischer Normen gewährleistet; EN 55014, EN 55104, EN 61000-3-2 und EN 61000-3-3.</p> <p><b>Anschlussmaße</b> (Abb. B)</p> <p><b>Position 1:</b> Empfohlene Stelle für den Austritt der elektrischen Versorgung aus der Wand (Kabel 3 x 1,5 mm<sup>2</sup> / Kabellänge 2600 mm).</p> <p><b>Position 2:</b> Empfohlene Stelle für den Kaltwasseranschluss DN 15 1/2" Innengewinde für die Verbindung zum Thermostat.</p> <p><b>Position 3:</b> Empfohlene Stelle für den Warmwasseranschluss DN 15 1/2" Innengewinde für die Verbindung zum Thermostat.</p> <p><b>Position 4:</b> Empfohlener Bereich für den Wasserablauf DN 50.</p> <p><b>Hinweis:</b> </p> <p>Mindestraumhöhe von 2300 mm notwendig!  <b>Einbau in fertig gefliestes Bad mit "Fliesenspiegel" auf mindestens 2200 mm!</b>            Erdungskabel: Querschnitt von mindestens 4 mm<sup>2</sup> und einer Länge von ca. 2600 mm!</p>	<p>These installation instructions contain the most important installing procedures and installation notes for the products stated on the front page. Please read these instructions carefully in order to avoid incorrect installation. The steam shower has been manufactured in accordance with the applicable regulations. Any improper installation may lead to injuries!</p> <p><b>Information</b></p> <p>The steam shower has been manufactured in compliance with the 73/23/EEC Low-Voltage Electrical Equipment Directive, 93/68 EEC Low-Voltage Electrical Equipment Directive and the CEI 64-8 (IEC 364) standard. The steam shower's degree of protection is IPX4, its rated voltage is 230 V, its rated output for the Steam and Deluxe versions is 2400 W.</p> <p>The compliance with the safety requirements (89/336/EEC, 92/31/EEC, 93/68/EEC guidelines) specified by the "European Guideline" for electro-magnetic compatibility is assured by the application of the following European standards; EN 55014, EN 55104, EN 61000-3-2 and EN 61000-3-3.</p> <p><b>Connection dimensions</b> (Fig. B)</p> <p><b>Position 1:</b> Recommended position for electrical supply cable exit from the wall (cable 3 x 1.5 mm<sup>2</sup> / cable length 2600 mm).</p> <p><b>Position 2:</b> Recommended position for cold water connection DN 15 1/2" internal thread for connection to the thermostat.</p> <p><b>Position 3:</b> Recommended position for warm water connection DN 15 1/2" internal thread for connection to the thermostat.</p> <p><b>Position 4:</b> Recommended area for water drainage DN 50.</p> <p><b>Note:</b> </p> <p>A minimum room height of 2300 mm is required! <b>Installation into completely tiled bathroom with a minimum "tiled area" of 2200 mm!</b>            Earthing cable: Cross section of at least 4 mm<sup>2</sup> and a length of approx. 2600 mm!</p>	<p>Le istruzioni di montaggio descrivono le più importanti operazioni di montaggio e le avvertenze di installazione per i prodotti indicati nella pagina di copertina. Leggere attentamente le istruzioni di montaggio per evitare errori. La doccia a vapore è stata realizzata conformemente alle direttive vigenti. Il montaggio scorretto può provocare lesioni!</p> <p><b>Informazione</b></p> <p>La doccia a vapore è stata realizzata conformemente alla direttiva sulla bassa tensione 73/23/CEE, 93/68 CEE ed alla norma CEI 64-8 (IEC 364). La classe di protezione della doccia a vapore è IPX4, la tensione nominale di 230 V e la potenza nominale di 2400 W per i modelli Steam e Deluxe.</p> <p>I requisiti di sicurezza previsti dalla direttiva europea sulla compatibilità elettromagnetica (direttiva 89/336/CEE, 92/31/CEE, 93/68/CEE) e la conformità vengono garantiti dall'applicazione delle seguenti norme europee: EN 55014, EN 55104, EN 61000-3-2 e EN 61000-3-3.</p> <p><b>Quote di collegamento</b> (fig. B)</p> <p><b>Posizione 1:</b> punto consigliato per la fuoriuscita del cavo di alimentazione elettrica dalla parete (cavo 3 x 1,5 mm<sup>2</sup> / lunghezza 2600 mm).</p> <p><b>Posizione 2:</b> punto consigliato per il raccordo dell'acqua fredda DN 15 1/2" con filettatura interna per il collegamento al termostato.</p> <p><b>Posizione 3:</b> punto consigliato per il raccordo dell'acqua calda DN 15 1/2" con filettatura interna per il collegamento al termostato.</p> <p><b>Posizione 4:</b> zona consigliata per lo scarico dell'acqua DN 50.</p> <p><b>Avvertenza:</b> </p> <p>Altezza minima del locale 2300 mm! <b>Montaggio in stanza da bagno piastrellata con altezza minima della piastrellatura di 2200 mm!</b>            Cavo di terra: sezione minima 4 mm<sup>2</sup> e lunghezza di circa 2600 mm!</p>

**Innenansicht**  
**Inside view**  
**Vista interna**

**A**

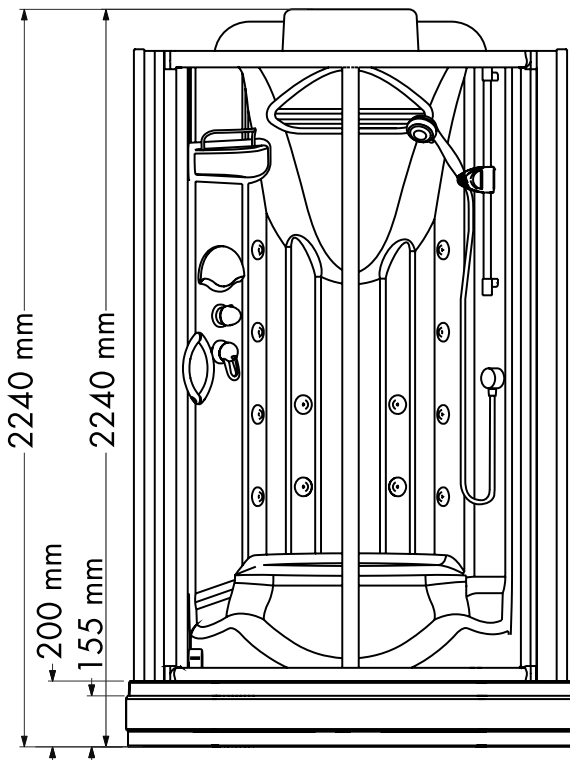

**Anschlussmaße**  
**Connection dimensions**  
**Quote di collegamento**

**B**

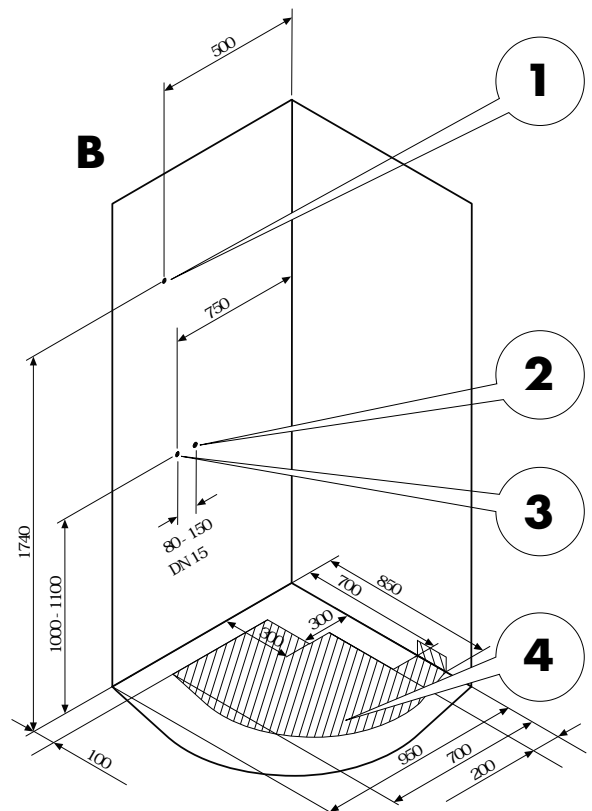

**Grundriss**  
**Ground plan**  
**Pianta**

**C**

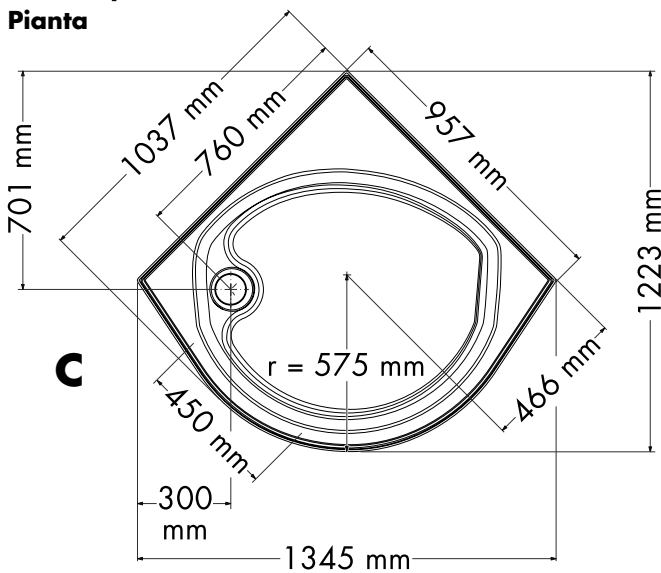

Markierter Bereich (4): Ideal für Wasserablauf  
 Marked area (4): ideal for water drainage  
 Zona a tratteggio (4): raccomandata per lo scarico

Deutsch	English	Italiano
<p><b>Grundausrüstung:</b></p> <ol style="list-style-type: none"> <li>1. Deckel</li> <li>2. Obere Abdeckung (Dach)</li> <li>3. Rückwand</li> <li>4. Ausgleichsprofil (vorne rechts)</li> <li>5. Trägerrahmen</li> <li>6. Duschwanne</li> <li>7. Wannenschürze</li> <li>8. Schiebetür (links oder rechts)</li> <li>9. Ausgleichsprofil (vorne links)</li> <li>10. Wandausgleichsprofil</li> <li>11. Seitenverkleidung</li> </ol> <p><b>Ausstattungsvarianten:</b></p> <p><b>A. Aquafun Shower</b> Duschkabine, Duschwanne und Wannenschürze sind aus ABS/PMMA. Schiebetür aus Sicherheitsglas zum Wenden (Links- oder Rechtsanschlag in einem). Steuerung der Duschfunktion: Thermostat (1/2") manuell, Ab- und Umstellung manuell.</p> <p>Bräusenbestückung (Anzahl):</p> <ul style="list-style-type: none"> <li>- 8 Pharo Seitenbräusen (Massagestrahl)</li> <li>- 4 Pharo Rückenbräusen (Massagestrahl)</li> <li>- 4 Nackenjets</li> <li>- Handbrause Mistral 3 (3 Strahlarten)</li> <li>- Raindance Kopfbrause (5 Strahlarten)</li> <li>- Unica D Bräusenstange (höhenverstellbar um 600 mm)</li> <li>- Kombination der Bräusen</li> </ul> <p><b>B. Aquafun Steam</b> Steuerung der Dampffunktion über einen Druckknopf:</p> <ul style="list-style-type: none"> <li>- Dampf an/aus (Leistung Dampfgenerator 2,4 kW)</li> <li>- Dufteinlass mit Aromasieb (sonst wie bei der Variante Aquafun Shower!)</li> </ul> <p><b>C./ D. Aquafun Comfort/ Deluxe</b> Steuerung der Dampffunktion über ein elektronisches Bedienelement:</p> <ul style="list-style-type: none"> <li>- Dampf an/aus (Leistung Dampfgenerator 2,4 kW)</li> <li>- Einstellbare Dampfzeit</li> <li>- Leistungsregulierung</li> <li>- Dufteinlass mit Aromasieb</li> </ul> <p><b>D. Aquafun Deluxe</b> Rückenbräusenfunktion und schottische Dusche, Beleuchtung mit Farblicht (LED) und einem integrierten Radio (sonst wie bei der Variante Aquafun Shower!)</p>	<p><b>Basic equipment:</b></p> <ol style="list-style-type: none"> <li>1. Cover</li> <li>2. Top cover (roof)</li> <li>3. Rear panel</li> <li>4. Compensation profile (right front)</li> <li>5. Support frame</li> <li>6. Shower tray</li> <li>7. Tray skirt</li> <li>8. Slide door (left or right)</li> <li>9. Compensation profile (left front)</li> <li>10. Wall compensation profile</li> <li>11. Side casing</li> </ol> <p><b>Equipment versions:</b></p> <p><b>A. Aquafun Shower</b>The shower cabin, shower tray and tray skirt are made of ABS/PMMA. Reversible slide door made of safety glass (combining a left and right hinging option). Shower function control: Manual thermostat (1/2"), manual off-switch and adjustment. Shower equipment (number):</p> <ul style="list-style-type: none"> <li>- 8 x Pharo side showers (massaging jet)</li> <li>- 4 x Pharo back showers (massaging jet)</li> <li>- 4 x neck jets</li> <li>- Mistral 3 hand shower (3 jet types)</li> <li>- Raindance head shower (5 jet types)</li> <li>- Unica D shower bar (height-adjustable by 600 mm)</li> <li>- Shower combination</li> </ul> <p><b>B. Aquafun Steam</b> Steam function control via a pushbutton:</p> <ul style="list-style-type: none"> <li>- Steam on/off (The steam generator's output amounts to 2.4 kW.)</li> <li>- Fragrance admission via an aroma filter (Further equipment identical with the Aquafun Shower version!)</li> </ul> <p><b>C./ D. Aquafun Comfort/ Deluxe</b> Steam control function via an electronic operating element:</p> <ul style="list-style-type: none"> <li>- Steam on/off (The steam generator's output amounts to 2.4 kW.)</li> <li>- Adjustable steam time</li> <li>- Output regulation</li> <li>- Fragrance admission via an aroma filter</li> </ul> <p><b>D. Aquafun Deluxe</b> back showers function and Scotch shower, colored-light illumination (LED) and an integrated radio. (Further equipment identical with the Aquafun Shower version!)</p>	<p><b>Equipaggiamento di base:</b></p> <ol style="list-style-type: none"> <li>1. Coperchio</li> <li>2. Copertura superiore (tetto)</li> <li>3. Pannello posteriore</li> <li>4. Profilato di compensazione (anteriore destro)</li> <li>5. Telaio</li> <li>6. Vasca della doccia</li> <li>7. Fascia di copertura del piatto doccia</li> <li>8. Porta scorrevole (a sinistra o a destra)</li> <li>9. Profilato di compensazione (anteriore sinistro)</li> <li>10. Profilato di compensazione a parete</li> <li>11. Pannello laterale</li> </ol> <p><b>Varianti di equipaggiamento:</b></p> <p><b>A. Aquafun Shower</b> La cabina doccia, la vasca della doccia e copertura dello zoccolo della vasca sono di ABS/PMMA. Porta scorrevole con vetro di sicurezza invertibile (apertura verso destra o verso sinistra). Controllo della funzione doccia: termostato (1/2") manuale, spegnimento e commutazione manuali. Numero di docce:</p> <ul style="list-style-type: none"> <li>- 8 docce laterali Pharo (per massaggio)</li> <li>- 4 docce posteriori Pharo (per massaggio)</li> <li>- 4 ugelli per la nuca</li> <li>- doccia manuale Mistral 3 (3 tipi di getto)</li> <li>- soffione doccia Raindance (5 tipi di getto)</li> <li>- asta scorrevole Unica D (regolabile in altezza di 600 mm)</li> <li>- combinazione delle docce</li> </ul> <p><b>B. Aquafun Steam</b> Controllo della funzione vapore mediante pulsante</p> <ul style="list-style-type: none"> <li>- vapore on/off (Potenza del generatore di vapore 2,4 kW)</li> <li>- ingresso essenze con filtro aroma (altre caratteristiche uguali alla variante Aquafun Shower).</li> </ul> <p><b>C./ D. Aquafun Comfort/ Deluxe</b> Controllo della funzione vapore mediante elemento di comando elettronico</p> <ul style="list-style-type: none"> <li>- vapore on/off (Potenza del generatore di vapore 2,4 kW)</li> <li>- durata del vapore regolabile</li> <li>- regolazione della potenza</li> <li>- ingresso essenze con filtro aroma</li> </ul> <p><b>D. Aquafun Deluxe</b> Funzione a cascata e doccia scozzese, illuminazione con luce colorata (LED) ed apparecchio radio integrato (altre caratteristiche uguali alla variante Aquafun Shower).</p>

**Aquafun 95 M 40 Shower**

21109000

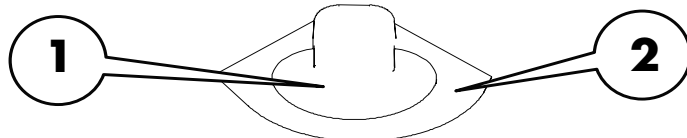
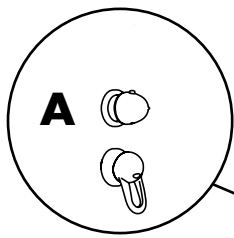

**Aquafun 95 ST 40 Steam**

21119000

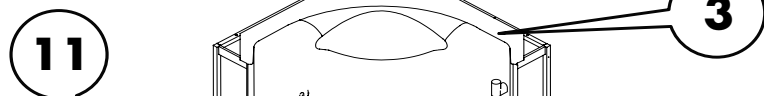
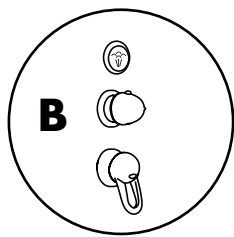

**Aquafun 95 Comfort**

21113000

**Aquafun 95 DL 40 Deluxe**

21129000

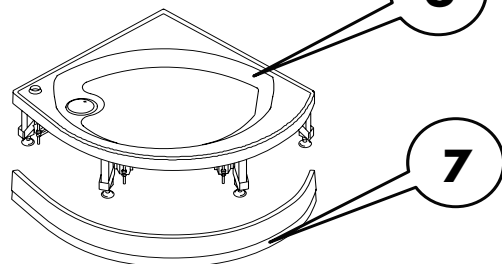
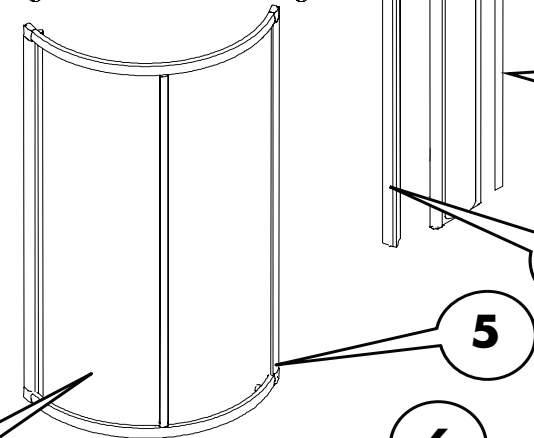
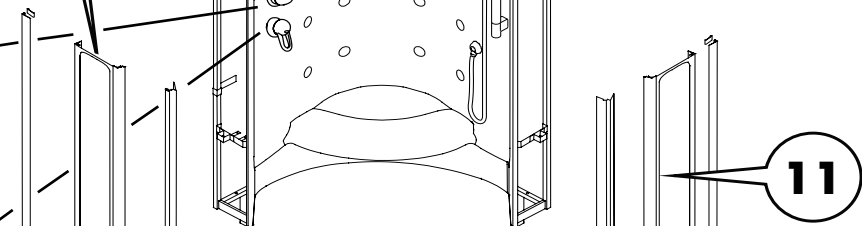
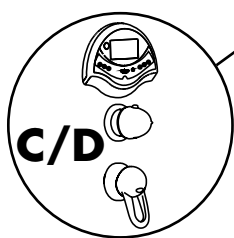







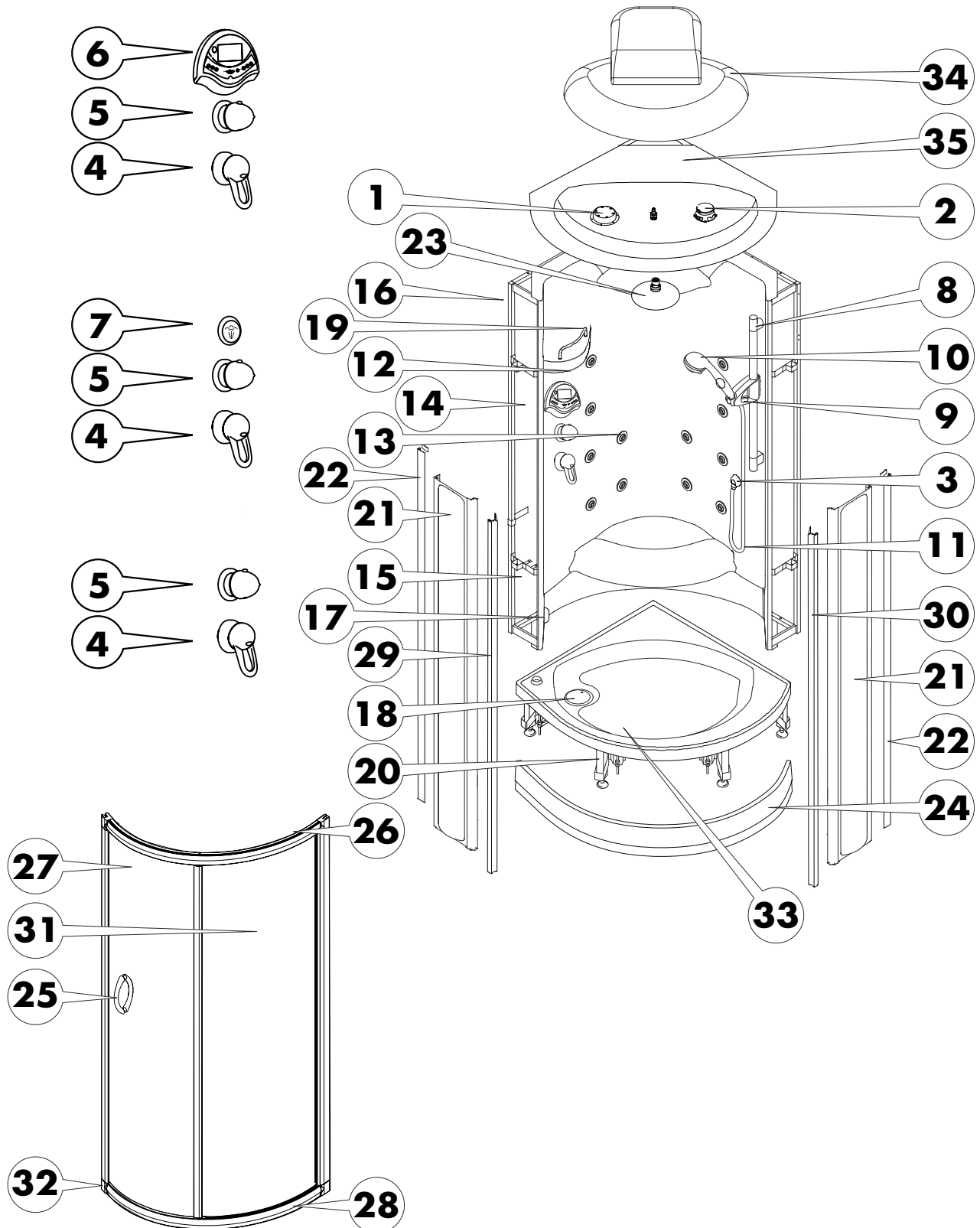











**Serviceteile**  
**Spare Parts**  
**Parti Di Ricambio**









Pos.	Bezeichnung	Description	Descrizione	Nr.	VE
1	Farblithherapie kpl. (Deluxe) Weißlicht (Comfort)	chromotherapy lamp light (Comfort)	cromoterapia luce bianca (Comfort)	96949000 97974000	1 1
2	Lautsprecher Deckel für Lautsprecher	speaker cover for speaker	altoparlante altoparlante	96950000 96951000	1 1
3	Abdeckung	cover	cappello	97454000	1
4	Ab- / Umstellventil Griff Rosette Ø 68 mm Mutter	shut off unit with selector handle escutcheon Ø 68 mm nut	cartuccia deviatore maniglia deviatore copertura Ø 68 mm ghiera di fissaggio	96645000 25936000 96944000 96945000	1 1 1 1
5	Temperatur Regeleinheit Thermostatgriff Anschlaghülse	thermostat cartridge handle for thermostat sleeve	cartuccia termostatica maniglia termostatico cappuccio	94282000 36391000 96946000	1 1 1
6	Bedienelement (Comf./ Deluxe)	control panel (Comf./ Deluxe)	display di comando(Comf./Del)	96952000	1
7	Drucktaster (Steam)	press switch (Steam)	pulsante (Steam)	96953000	1
8	Wandstange	wall bar	asta doccia	25957000	1
9	Schieber U'D kpl.	support U'D	supporto doccetta	96190000	1
10	Handbrause	handshower	doccetta	28524000	1
11	Brauseschlauch	shower hose	flessibile	28246000	1
12	Nacken Düse	neck jet	getti cervicali	96954000	1
13	Seitenbrause	body shower	doccia laterale	25944000	1
14	Magnetventil 1 Weg / 12V Bajonettverschluss 3/4" M	1 way 12V solenoid valve 3/4" male bayonet fitting	elettrovalvola 1 via 12V Raccordo 3/4" M con innesto a Baionetta	96955000 97374000	1 1
15	Dampfgenerator kpl. Wasserstandsensoren Potentiometer für Wasserstand- sensor Magnetventil Zulauf Dampfgenerator Magnetventil Wasserabfluss Dampfgenerator Heizspirale (230V/2400W) Überhitzungsschutz Thermostat	boiler water level sensor potentiometer for water level sensor solenoid valve water supply steam generator solenoid valve water drain boiler heating spiral(230V/2400W) overheating protection for thermostat	corpo caldaia asta livello sensore di livello elettrovalvola connessione elettrovalvola scarico corpo caldaia resistenza (230V/2400W) termofusibile	96956000 96957000 96958000 97352000 96959000 96960000 97124000	1 1 1 1 1 1 1
16	Schaltkasten (Comfort/Deluxe) Schaltkasten (Steam)	control unit (Comfort/Deluxe) control unit (Steam)	centralina (Comfort/Deluxe) centralina (Steam)	96962000 96961000	1 1
17	Dampfaustritt	steam outlet	diffusore di vapore	96963000	1
18	Staro 90 Color Set Staro 90 Grundset	Staro 90 colour kit Staro 90 basic kit	set colorato Staro 90 corpo base Staro 90	60055000 96964000	1 1
19	Reling (240mm)	rail (240mm)	ferma oggetti (240mm)	96965000	1
20	Wannenfüße	shower tray feet	piedini del piatto doccia	96967000	1
21	Seitenverkleidung	side casing	pannello ispezionabile	96977320	1
22	Wandausgleichschiene (links/rechts)	wall closure rail (right/left)	profilo compensatore (sinistro/destro)	96981000	1
23	Kopfbrause	head shower	soffione doccia	97366000	1
24	Wannenschürze	skirt	pannello frontale piatto	96984320	1
25	Türgriff	door handles	maniglie per porte	96989000	1
26	Türstopper	door stopper	ferma porta	96990000	1
27	Schiebetür Gleitrolle Dichtung (Tür unten)	sliding door sliding roller seal (bottom of the door)	anta scorrevole porta scorrevole guarnizione (parte inferiore dell'anta fissa)	97001000 97003000 97004000	1 2 1
	Dichtung (Tür oben)	seal (top of the door)	guarnizione (parte superiore anta fissa)	96992000	1
28	Dichtung Glasabtrennung/Duschwanne	seal glass/shower tray	guarnizione piatto	96991000	1
29	Ausgleichsprofil Dichtung	closure rail seal	profilo compensatore guarnizione	96994000 97353000	1 2
30	Ausgleichsprofil Dichtung	closure rail seal	profilo compensatore guarnizione	96995000 97353000	1 2
31	Tür fest	fixed door	anta fissa	97006000	1
32	Eckprofil	corner profile	raccordo unione	97007000	1
33	Duschwanne inkl. Ventil	shower tub incl. drain outlet	piatto completo di scarico	97013320	1
34	Dachabdeckung	top cover	sovracappello	97016320	1

Pos.	Bezeichnung	Description	Descrizione	Nr.	VE
35	Dach (Deluxe)	top (Deluxe)	capello (Deluxe)	97113320	1
	Dach (Comfort)	top (Comfort)	capello (Comfort)	97975320	1
	Dach (Shower/Steam)	top (Shower/Steam)	capello (Shower/Steam)	97021320	1
-	Befestigungssatz	mounting kit	set di fissaggio	96970000	1
-	Satz Zierkappen	set of caps	set di cappa	97434000	1



Deutsch	English	Italiano
<p><b>Vor dem Einbau bitte prüfen:</b></p> <ol style="list-style-type: none"> <li>1. Die Tragfähigkeit des Fußbodens muss einer Belastung von 200 kg/m<sup>2</sup> entsprechen.</li> <li>2. Der Fußboden muss ausreichend nivelliert sein, d.h. ein waagerechter und ebener Fußboden.</li> <li>3. Der Fußboden muss im Einbaubereich gefliest sein.</li> </ol> <p><b>Gefahr!</b> </p> <p><b>Allgemein:</b>  Während Reinigungs- und Wartungsarbeiten muss der Hauptschalter auf "OFF" gestellt sein.  Wartungs- und Einstellarbeiten dürfen nur von einem Fachmann durchgeführt werden.  Nach Wartungsarbeiten müssen die Serviceabdeckungen ordnungsgemäß montiert werden.  Bestehende Sicherheitsvorkehrungen und Sicherheitseinrichtungen dürfen nicht verändert oder entfernt werden.</p> <p><b>Hinweis:</b> </p> <p>Die Dampfdusche darf in ihrer Bauart nicht verändert werden. Nur Originalersatzteile verwenden.</p> <p><b>Stromversorgung:</b>  Der Elektroanschluss sollte ausschließlich vom Elektrofachmann bzw. Elektro-Installateur durchgeführt werden. Die gesamte Stromversorgung erfolgt über einen 230 V/50 Hz Wechselstromanschluss und muss über einen 2-poligen FI-Schalter mit 30 mA Fehlerstrom abgesichert werden.</p> <p>Bei der Elektro-Installation sind die entsprechenden VDE-, Landes- und EVU-Vorschriften in der jeweils gültigen Fassung einzuhalten. Die Installations- und Prüfungsarbeiten sind von einem zugelassenen Elektrofachmann auszuführen, unter Berücksichtigung von VDE 0100 Teil 701. Sämtliche Arbeiten an der Dampfdusche dürfen nur im spannungsfreien Zustand vorgenommen werden!</p>	<p><b>Please assure before installation:</b></p> <ol style="list-style-type: none"> <li>1. The floor's carrying capacity must correspond to a load of 200 kg/m<sup>2</sup>.</li> <li>2. The floor must be sufficiently leveled, i.e. it must be horizontal and even.</li> <li>3. The floor's installation area must be tiled.</li> </ol> <p><b>Danger!</b> </p> <p><b>General:</b>  The main switch must be set to "OFF" during cleaning and maintenance works.  Maintenance and adjustment works must be carried out by experts only.  All service covers must be appropriately re-installed after maintenance works.  Any installed safety provisions or safety equipment may not be modified or removed.</p> <p><b>Note:</b> </p> <p>The steam shower's construction must not be changed. Only original components may be used.</p> <p><b>Power supply:</b>  The electrical connection should only be carried out by an electrician, i.e. your electrical installer. The entire power supply is realized via a 230 V/50 Hz AC connection and must be fused via a 2-pole RCCB with a residual current of 30 mA.</p> <p>For electrical installation, all applicable VDE, country-specific and EVU regulations in their respectively valid versions must be observed. All installation and inspection works must be carried out by an approved electrician and in accordance with VDE 0100 Part 701. All works at the steam shower may only be carried out in a de-energized state!</p>	<p><b>Da controllare prima del montaggio:</b></p> <ol style="list-style-type: none"> <li>1. La portata minima del pavimento deve essere di 200 kg/m<sup>2</sup>.</li> <li>2. Il pavimento deve essere orizzontale e sufficientemente piano.</li> <li>3. La zona del pavimento su cui si monta la cabina deve essere piastrellata.</li> </ol> <p><b>Pericolo!</b> </p> <p><b>Generalità:</b>  Durante i lavori di pulizia e di manutenzione, l'interruttore generale deve essere su "OFF".  Gli interventi di manutenzione e regolazione devono essere svolti solo da un tecnico autorizzato.  Al termine della manutenzione si devono rimontare correttamente le coperture di servizio.  I dispositivi di sicurezza installati non devono essere né modificati né rimossi.</p> <p><b>Avvertenza:</b> </p> <p>La struttura della doccia a vapore non deve essere modificata. Usare solo ricambi originali.</p> <p><b>Alimentazione elettrica:</b>  L'allacciamento elettrico deve essere eseguito solo da un tecnico (elettricista esperto). L'intero sistema viene alimentato a tensione alternata a 230 V/50 Hz e l'impianto deve possedere un interruttore di sicurezza per correnti di guasto (salvavita) bipolare con corrente di apertura di 30 mA.</p> <p>Per l'impianto elettrico si devono rispettare le norme CEI e dell'azienda elettrica vigenti.  I lavori di installazione e di collaudo devono essere svolti da un tecnico autorizzato nel rispetto delle VDE 0100, parte 701. Qualsiasi intervento sulla doccia a vapore va eseguito solo dopo aver staccato la tensione elettrica!</p>

Deutsch	English	Italiano
<p>Die in der Montageanleitung verwendeten Symbole sind im folgenden Text näher beschrieben.</p> <p><b>Gefahr durch Stromschlag!</b></p> <p><b>Gefahr!</b>  Bezeichnet eine <b>unmittelbar</b> drohende Gefahr <b>durch Stromschlag</b>. Wenn diese nicht gemieden wird, sind <b>Tod oder schwerste Verletzungen</b> die Folge!</p> <p><b>Warnung!</b>  Bezeichnet eine möglicherweise gefährliche Situation. Wenn diese nicht gemieden wird, können <b>Tod oder schwerste Verletzungen</b> die Folge sein!</p> <p><b>Vorsicht!</b>  Bezeichnet eine möglicherweise gefährliche Situation. Wenn diese nicht gemieden wird, können <b>leichte oder geringfügige Verletzungen</b> sowie Sachschäden die Folge sein!</p> <p><b>Achtung, zwei Personen notwendig!</b></p> <p><b>Achtung!</b>  Bezeichnet eine bestimmte Vorgehensweise. Wenn diese nicht eingehalten wird, kann das Produkt oder etwas in seiner Umgebung beschädigt werden. (Die Montage der Dampfdusche muss von zwei Personen durchgeführt werden)!</p>	<p>The symbols used within these installation instructions are further described within the following text.</p> <p><b>Danger of electric shock!</b></p> <p><b>Danger!</b>  Describes an <b>imminent</b> danger of <b>electric shock</b>. If this danger is not evaded, the consequences are <b>death or serious injuries!</b></p> <p><b>Warning!</b>  Describes a possibly dangerous situation. If this situation is not evaded, the consequences are <b>death or serious injuries!</b></p> <p><b>Caution!</b>  Describes a possibly dangerous situation. If this situation is not evaded, the consequences are <b>slight or insignificant injuries</b> as well as property damage!</p> <p><b>Attention, two persons required!</b></p> <p><b>Attention!</b>  Describes a specific procedure. If this procedure is not observed, the product or objects within its environment may be damaged. (The steam shower's installation must be carried out by two persons!)</p>	<p>I simboli utilizzati in queste istruzioni di montaggio vengono descritti dettagliatamente qui di seguito.</p> <p><b>Pericolo di folgorazione elettrica!</b></p> <p><b>Pericolo!</b>  Indica un pericolo <b>imminente di folgorazione elettrica</b>. Ne derivano <b>la morte o gravissime lesioni!</b></p> <p><b>Avvertimento!</b>  Indica una situazione pericolosa. Ne possono derivare <b>la morte o gravissime lesioni!</b></p> <p><b>Cautela!</b>  Indica una situazione pericolosa. Ne possono derivare <b>lievi lesioni</b> o danni materiali!</p> <p><b>Attenzione: sono necessarie due persone!</b></p> <p><b>Attenzione!</b>  Indica un determinato procedimento. Se non viene rispettato, il prodotto o oggetti nelle sue vicinanze possono essere danneggiati (il montaggio della doccia a vapore deve essere eseguito da due persone)!</p>

Deutsch	English	Italiano
<p><b>Hinweis:</b> </p> <p><b>(Hinweisschild z.B. i )</b>            Bezeichnet Anwendungstipps und andere besondere nützliche Situationen, wobei keine gefährlichen oder schädlichen Situationen auftreten.</p> <p><b>Installateur notwendig!</b></p> <p><b>Installateur!</b> </p> <p>Beschreibt Montagearbeiten, die nur von einem Installateur durchgeführt werden dürfen.</p> <p><b>Elektriker notwendig!</b></p> <p><b>Elektriker!</b> </p> <p>Beschreibt Montagearbeiten die nur von einem Elektrofachmann durchgeführt werden dürfen.</p>	<p><b>Note:</b> </p> <p><b>(Note sign, e.g. i )</b>            Describes application tips and further particularly useful situations, however, no dangerous or harmful situations.</p> <p><b>Installer required!</b></p> <p><b>Installer!</b> </p> <p>Describes installation works that may only be carried out by an installer.</p> <p><b>Electrician required!</b></p> <p><b>Electrician!</b> </p> <p>Describes installation works that may only be carried out by an electrician.</p>	<p><b>Avvertenza:</b> </p> <p><b>(cartello di avvertenza, ad esempio "i")</b>            Indica suggerimenti ed altre azioni particolarmente utili per le quali non si presentano situazioni dannose o pericolose.</p> <p><b>Necessità di un installatore!</b></p> <p><b>Installatore!</b> </p> <p>Descrive lavori di montaggio che devono essere svolti solo da un installatore auto-rizzato.</p> <p><b>Necessità di un elettricista!</b></p> <p><b>Elettricista!</b> </p> <p>Descrive lavori di montaggio che devono essere svolti solo da un elettricista auto-rizzato.</p>

Deutsch

English

Italiano

**Technische Daten :**

Mindestfließdruck:	2 bar
Betriebsdruck:	max. 10 bar
Empfohlener Betriebsdruck:	2 – 5 bar
Prüfdruck:	16 bar
Heißwassertemperatur:	max. 70 °C
Empfohlene Heißwasser- Temperatur:	60 °C
Temperaturskala:	20 – 60 °C
Sicherheitsperre:	38 °C

**Durchflussleistung bei 3 bar:**

Handbrause:	15,5 l/min
Hand- und Kopfbrause:	25,6 l/min
Hand- und Rückenbrause:	25,3 l/min
Seitenbrausen:	20,3 l/min
Kopfbrause:	19,6 l/min
Kopf- und Seitenbrause:	28,0 l/min
Nackenbrause:	15,8 l/min
Rückenbrause:	24,1 l/min
Rücken- und Nackenbrause:	25,3 l/min
Dampferzeuger:	2,0l/30min

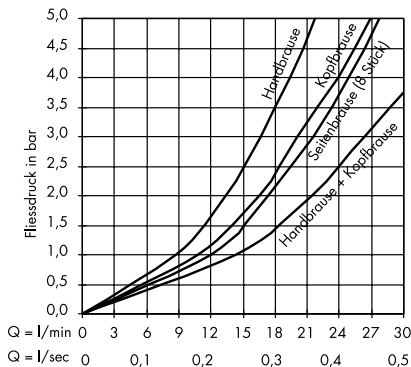

Funktionstüchtig ab 2 bar. Es dürfen maximal 2 Verbraucher zusammengeschaltet werden. Anschluss für Wasserzulauf und Wasserablauf sind nach den derzeit gültigen DIN 1988/EN1717 und den örtlichen Vorschriften zu installieren.

**Hinweis:**

**Durchlauferhitzer:**

Die Dampfdusche kann nicht in Verbindung mit hydraulisch, elektronisch und thermisch gesteuerten Durchlauferhitzern eingesetzt werden.

**Druckunterschiede:**

Die Drücke zwischen den Kalt- und Warmwasseranschlüssen müssen ausgeglichen werden.

**Werkstoff:**

Sanitäracryl mit ABS als Verbundwerkstoff.

**Technical information:**

Minimum flow pressure:	2 bar
Operating pressure:	max. 10 bar
Recommended operating pressure:	2 – 5 bar
Test pressure:	16 bar
Hot water temperature:	max. 70 °C
Recommended hot water temperature:	60 °C
Temperature scale:	20 – 60 °C
Safety barrier:	38 °C

**Flow rate at 3 bar:**

Hand shower:	15.5 l/min
Hand and head shower:	25.6 l/min
Hand and back shower:	25.3 l/min
Side showers:	20.3 l/min
Head shower:	19.6 l/min
Head side shower:	28.0 l/min
Neck shower:	15.8 l/min
Back shower:	24.1 l/min
Back and neck shower:	25.3 l/min
Steam generator:	2.0l/30min

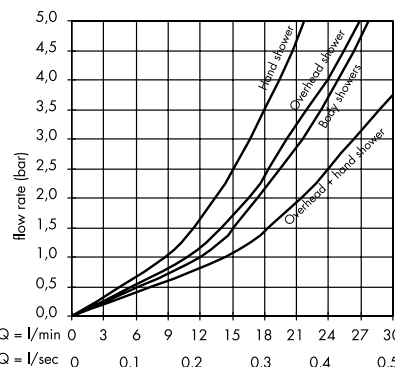

Operable as of 2 bar. A maximum of two loads may be interconnected. The connections for water intake and water drainage must be installed in accordance with the currently valid DIN 1988/EN1717 standard and the local regulations.

**Note:**

**Flow-type water heater:**

The steam shower cannot be applied in connection with hydraulically, electronically or thermally controlled flow-type water heaters.

**Pressure differentials:**

The pressure values between the cold and warm water connections must be compensated.

**Material:**

Sanitary acrylic with ABS as compound material.

**Dati tecnici:**

Pressione dinamica minima:	2 bar
Pressione di esercizio:	max. 10 bar
Pressione di esercizio consigliata:	2 – 5 bar
Pressione di prova:	16 bar
Temperatura dell'acqua calda:	max. 70 °C
Temperatura consigliata dell'acqua calda:	60 °C
Scala della temperatura:	20 – 60 °C
Blocco di sicurezza:	38 °C

**Portata a 3 bar:**

Doccia manuale:	15,5 l/min
Doccia manuale e soffione:	25,6 l/min
Doccia manuale e posteriore:	25,3 l/min
Docce laterali:	20,3 l/min
Doccia di testa:	19,6 l/min
Doccia manuale e laterale:	28,0 l/min
Doccia della nuca:	15,8 l/min
Doccia posteriore:	24,1 l/min
Doccia posteriore e della nuca:	25,3 l/min
Generatore di vapore:	4,0 l/h

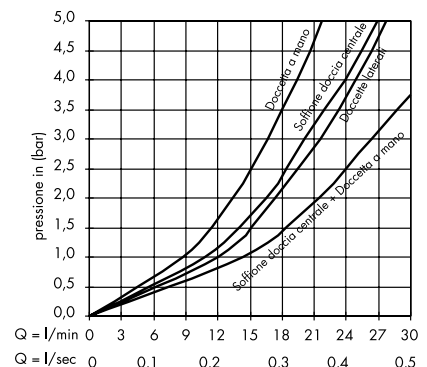

Funzionalità a partire da 2 bar. Si possono collegare insieme massimo 2 utenze. I raccordi di mandata e di scarico dell'acqua vanno installati conformemente alle DIN 1988/EN1717 ed alle norme locali.

**Avvertenza:**

**Scaldacqua istantaneo:**

La doccia a vapore non può essere impiegata in combinazione con uno scaldacqua istantaneo controllato idraulicamente, elettronicamente o termicamente.

**Differenze di pressione:**

Le pressioni tra i raccordi dell'acqua fredda e calda devono essere compensate.

**Materiale:**

Acrilico per articoli igienico-sanitari con ABS come materiale composito.

Deutsch	English	Italiano
<p><b>A. Duschwanne/ Dach/ Dachabdeckung/ Schürze/ Montagezubehör</b></p> <p>Duschwanne  Wannenschürze  Dachabdeckung  Obere Abdeckung (Dach)  Brauseschlauch  Handbrause  Türgriffe  Schrauben-Set  Montage-Set (Befestigungswinkel)  Türdichtung  Winkelstück G 1/2 mit Absperrung mit Rückflußverhinderer</p> <p><b>B. Rückwand</b></p> <p>Rückwand  Ausgleichsprofil (vorne rechts)  Ausgleichsprofil (vorne links)  Wandausgleichsprofil  Seitenverkleidung</p> <p><b>C. Tür, Seitenscheibe</b></p> <p>Schiebetür  Trägerrahmen</p>	<p><b>A. Shower tray/cover/top cover/ skirt/ installation accessories</b></p> <p>Shower tray  Tray skirt  Roof cover  Top cover (roof)  Shower tube  Hand shower  Door handles  Screw set  Installation set (angle brackets)  Door sealing  Angle piece G 1/2 with locking with non return valve</p> <p><b>B. Rear panel</b></p> <p>Rear panel  Compensation profile (right front)  Compensation profile (left front)  Wall compensation profile  Side casing</p> <p><b>C. Door, side pane</b></p> <p>Slide door  Support frame</p>	<p><b>A. Vasca della doccia / tetto / sovracappello/ copertura / accessori di montaggio</b></p> <p>Vasca della doccia  Fascia di copertura del piatto doccia  Copertura del tetto  Copertura superiore (tetto)  Tubo flessibile della doccia  Doccia manuale  Maniglie della porta  Kit di viti  Kit di montaggio (angolari di fissaggio)  Guarnizione della porta  Elemento angolare G 1/2 con bloccaggio &amp; valvola antiriflusso</p> <p><b>B. Pannello posteriore</b></p> <p>Pannello posteriore  Profilato di compensazione (anteriore destro)  Profilato di compensazione (anteriore sinistro)  Profilato di compensazione a parete  Pannello laterale</p> <p><b>C. Porta, pannello laterale</b></p> <p>Porta scorrevole  Telaio</p>

**Duschwanne/Dach/ Dachabdeckung/ Schürze/Montagezubehör**  
**Shower tray/roof/top cover/ skirt/installation accessories**  
**Piatto doccia/tetto/sovracappello/ fascia di copertura del piatto doccia/accessori di montaggio**

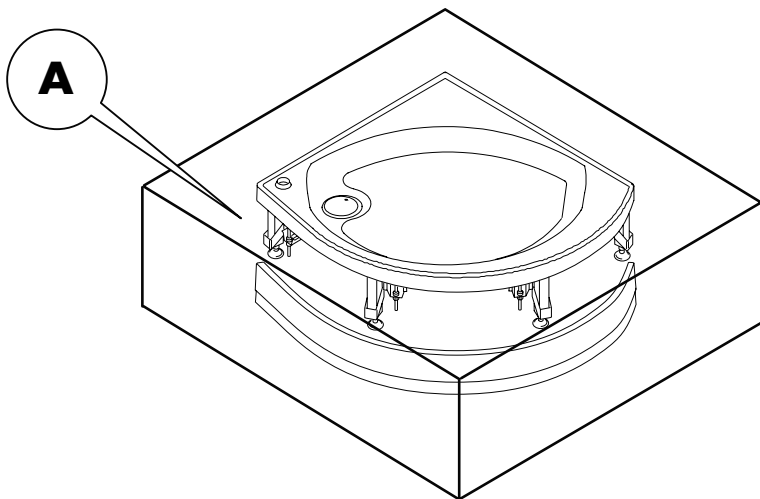

**Rückwand**  
**Rear panel**  
**Pannello posteriore**

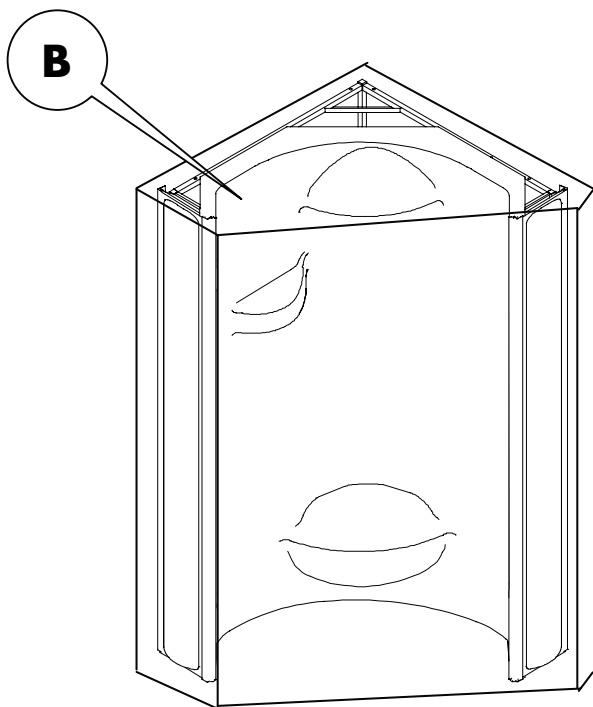

**Tür/Seitenscheibe**  
**Door/side panel**  
**Porta/pannello laterale**

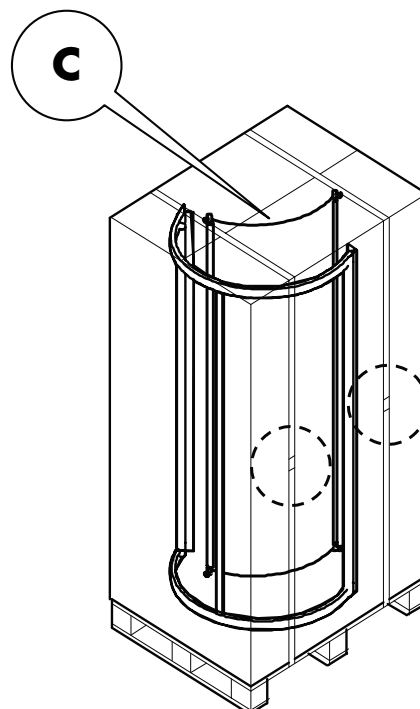

**Benötigte Werkzeuge**  
**Required Tools**  
**Attrezzi necessari**



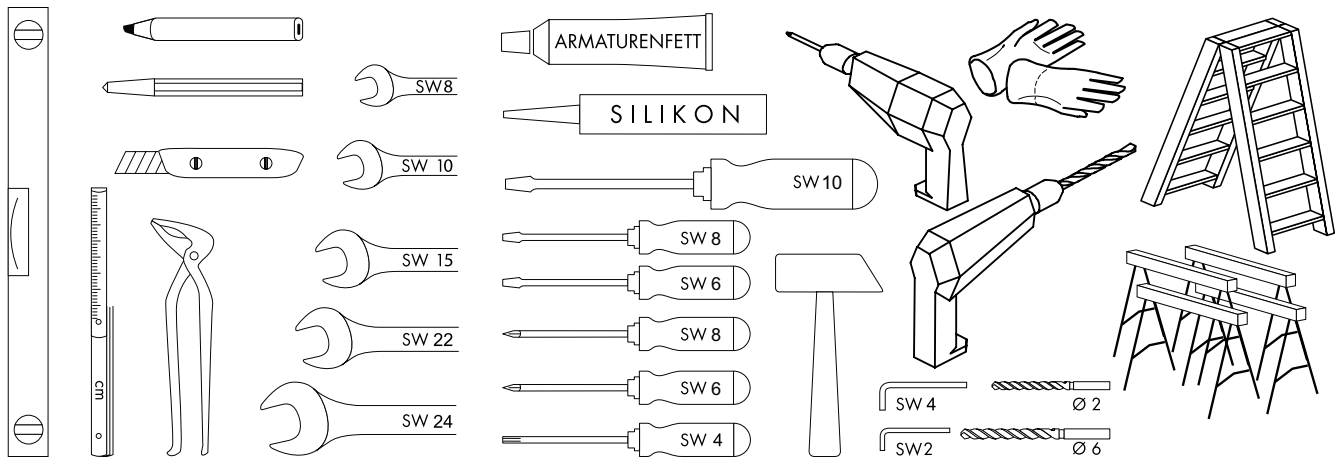



Deutsch	English	Italiano
<p><b>Folgend aufgeführtes Werkzeug und Zubehör ist für die Montage notwendig:</b></p> <ul style="list-style-type: none"> <li>- Wasserwaage</li> <li>- Meterstab</li> <li>- Zeichenstift und Körner</li> <li>- Wasserpumpenzange</li> <li>- Maulschlüssel-Set (SW 8, 10, 15, 22, 24)</li> <li>- Inbusschlüssel (SW 2, 4)</li> <li>- Vielzahnschraubendreher (4 mm)</li> <li>- Kreuzschlitzschraubendreher (6, 8 mm)</li> <li>- (Flach-) Schraubendreher (6, 8, 10 mm)</li> <li>- Hammer (kleiner Schlosserhammer)</li> <li>- Armaturenfett</li> <li>- Silikon (essigsäurefrei)</li> <li>- Bohrer (2, 6 mm)</li> <li>- Messer</li> <li>- Bohrmaschine</li> <li>- Akkuschauber</li> <li>- 4 Montageböcke</li> <li>- Leiter</li> </ul>	<p><b>The following tools and accessories are required for installation:</b></p> <ul style="list-style-type: none"> <li>- Water level</li> <li>- Pocket rule</li> <li>- Pencil and punch</li> <li>- Water pump tongs</li> <li>- Wrench set (SW 8, 10,15, 22, 24)</li> <li>- Socket wrench (SW 2, 4)</li> <li>- Multi-tooth screwdriver (4 mm)</li> <li>- Crosstip screwdriver ( 6, 8 mm)</li> <li>- (Flat) screwdriver (6, 8, 10 mm)</li> <li>- Hammer (small fitter's hammer)</li> <li>- Fittings grease</li> <li>- Silicone (free of acetic acid)</li> <li>- Crosstip screwdriver ( 2, 6 mm)</li> <li>- Knife</li> <li>- Drilling machine</li> <li>- Electric screwdriver</li> <li>- 4 installation blocks</li> <li>- Ladder</li> </ul>	<p><b>Per il montaggio sono necessari i seguenti attrezzi ed accessori:</b></p> <ul style="list-style-type: none"> <li>- Livella a bolla d'aria</li> <li>- Metro</li> <li>- Matita e punzone (per piastrelle)</li> <li>- Chiave stringitubo</li> <li>- Set di chiavi fisse (da 8, 10,15, 22, 24)</li> <li>- Chiave a brugola (da 2, 4)</li> <li>- Cacciavite dentato (4 mm)</li> <li>- Cacciavite a stella (6, 8 mm)</li> <li>- Cacciavite (piatto) (6, 8, 10 mm)</li> <li>- Martello (non da fabbro)</li> <li>- Grasso per rubinetteria</li> <li>- Silicone (privo di acido acetico)</li> <li>- Punta (2, 6 mm)</li> <li>- Coltello</li> <li>- Trapano</li> <li>- Avvitatore</li> <li>- 4 cavalletti di montaggio</li> <li>- Scala</li> </ul>



# Einstellung WannenfüÙe/Ausrichtung Duschwanne

## Shower Tray Feet Setting/Shower Tray Alignment

### Regolazione dei piedi del piatto doccia/posizionamento del piatto doccia

Deutsch	English	Italiano
<p><b>Voreinstellung (Abbildung A und B):</b></p> <ul style="list-style-type: none"> <li>Die WannenfüÙe (3) am Duschwannengestell so einstellen, dass der Abstand von Unterkante Duschwanne (5) zum Fußboden 158 mm beträgt.</li> </ul> <p><b>Achtung!</b> </p> <ul style="list-style-type: none"> <li>Die Duschwanne zu zweit sehr vorsichtig in die Einbauposition bringen.</li> <li>Einbauposition Wannenschürze (6) prüfen.</li> <li>Hinterer WannenuÙ (2) nach der Feinjustierung mit dem Maulschlüssel SW 15 durch die Kontermutter sichern!</li> </ul> <p><b>Feineinstellung (Abbildung C):</b></p> <ul style="list-style-type: none"> <li>Duschwanne (1) mit Wasserwaage (4) ausrichten. Feinjustierung durch Ein- oder Ausdrehen der WannenfüÙe (3). Kontermutter der WannenfüÙe mit dem Maulschlüssel SW 15 sichern.</li> </ul> <p><b>Hinweis:</b> </p> <p>Die Vorderkante der Duschwanne (Abb. C) muss mit der Wasserwaage (4) geprüft und an den WannenfüÙen (3) feinjustiert werden!</p> <p>Zum leichteren Aufbauen der Kabine, die Duschwanne zu zweit wieder ein Stück aus dem Eck heraussetzen.</p>	<p><b>Pre-adjustment (Fig. A and B):</b></p> <ul style="list-style-type: none"> <li>Adjust the tray feet (3) at the shower tray framing in a way which ensures that the clearance between the shower tray's lower edge (5) and the floor amounts to 158 mm.</li> </ul> <p><b>Attention!</b> </p> <ul style="list-style-type: none"> <li>Two persons must very carefully place the shower tray in its installation position.</li> <li>Check the tray skirt's (6) installation position.</li> <li>After fine adjustment, the rear tray foot's (2) counter nut must be secured using an SW 15 wrench!</li> </ul> <p><b>Fine adjustment (Fig. C):</b></p> <ul style="list-style-type: none"> <li>Position the shower tray (1) with the help of a water level (4). Carry out the fine adjustment by screwing the tray feet (3) in or out. Secure the tray feet's counter nut using an SW 15 wrench.</li> </ul> <p><b>Note:</b> </p> <p>The position of the shower tray's front edge (Fig. C) must be measured with the water level (4) and finely adjusted at the tray feet (3)!</p> <p>The shower tray should be slightly repositioned away from the corner by two persons in order to facilitate the cabin's assembly.</p>	<p><b>Operazioni preliminari (figg. A e B):</b></p> <ul style="list-style-type: none"> <li>Regolare i piedi (3) del telaio del piatto doccia in modo che la distanza dal bordo inferiore del piatto doccia (5) al pavimento sia di 158 mm.</li> </ul> <p><b>Attenzione!</b> </p> <ul style="list-style-type: none"> <li>Collocare il piatto doccia in posizione di montaggio (in due persone) con estrema cautela.</li> <li>Controllare la posizione di montaggio della fascia die copertura del piatto doccia (6).</li> <li>Dopo la regolazione di precisione bloccare il piede posteriore (2) con il controdado mediante la chiave fissa da 15!</li> </ul> <p><b>Regolazione di precisione (fig. C):</b></p> <ul style="list-style-type: none"> <li>Livellare il piatto doccia (1) con la livella a bolla d'aria (4). Regolazione di precisione avvitando o svitando i piedi (3). Bloccare il controdado con la chiave fissa da 15.</li> </ul> <p><b>Avvertenza:</b> </p> <p>Il bordo anteriore del piatto doccia (fig. C) deve essere controllato con la livella a bolla d'aria (4) e regolato agendo sui piedi (3)!</p> <p>Per facilitare il montaggio della cabina, allontanare in due il piatto doccia di un tratto dall'angolo.</p>

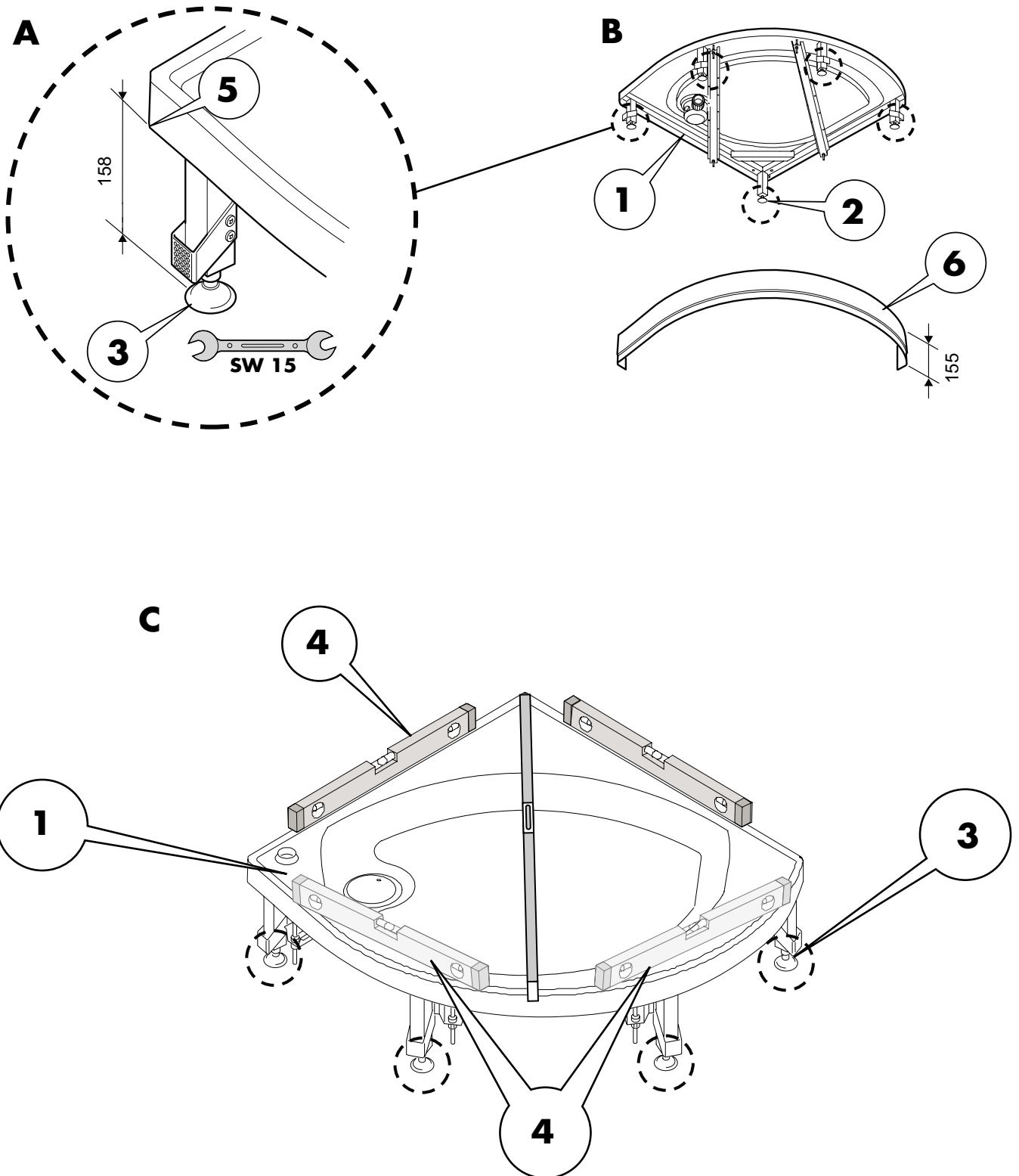

Einstellung WannenfüÙe/Ausrichtung Duschwanne  
Shower Tray Feet Setting/Shower Tray Alignment  
Regolazione dei piedi del piatto doccia/posizionamento del piatto doccia



# Seitenverkleidung abnehmen

## Removing the Side Casing







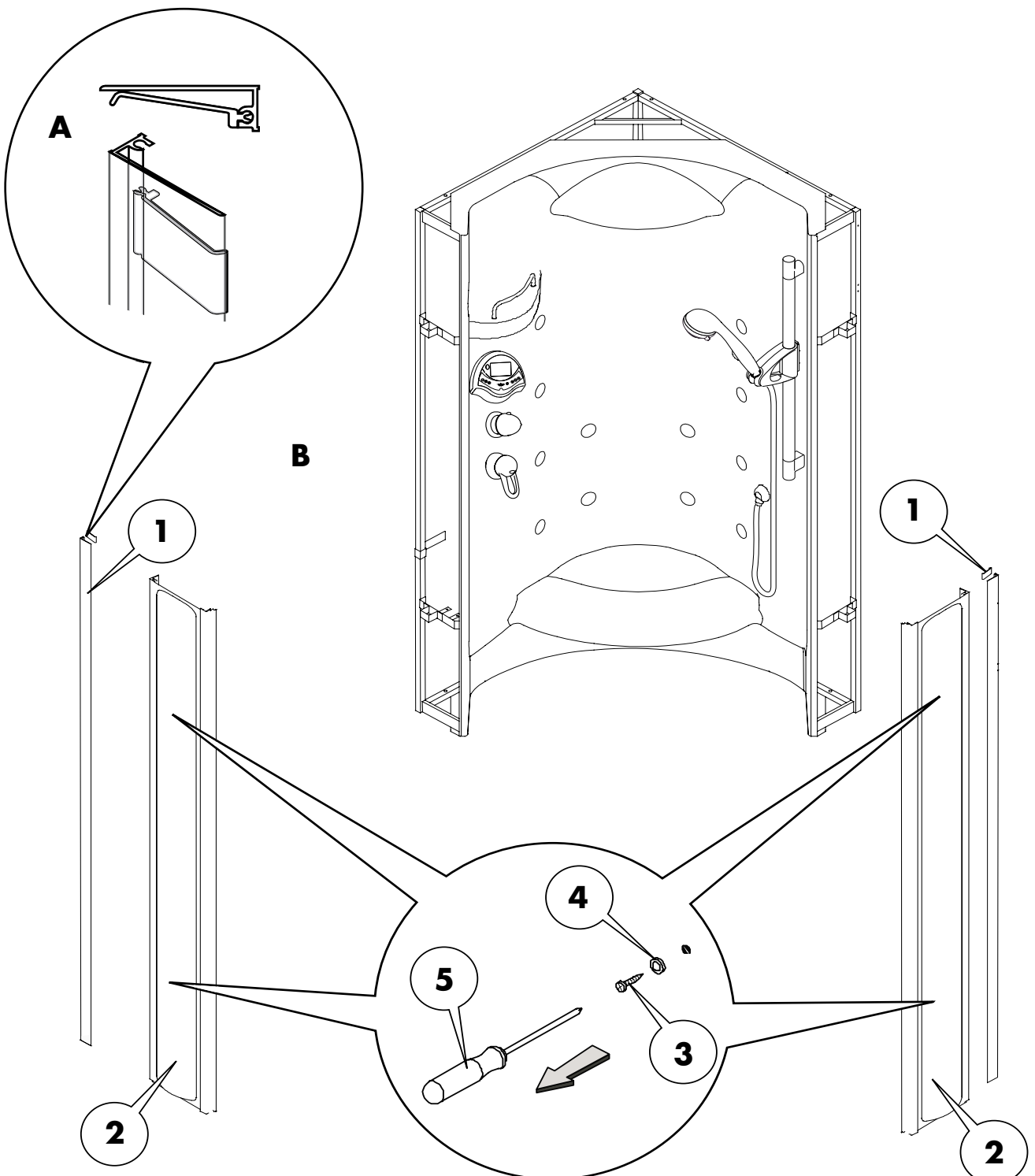

### Smontaggio del pannello laterale

Deutsch	English	Italiano
<ul style="list-style-type: none"><li>• Seitenverkleidung (2) und Wandausgleichsprofil (1) von der Rückwand entfernen.</li><li>• Mit Schraubendreher (5) Schrauben (3) lösen und mit den Unterlegscheiben (4) entfernen (Abb. B).</li><li>• Seitenverkleidung und Wandausgleichsprofil abnehmen.</li></ul> <p><b>Hinweis:</b> </p> <p>Das Wandausgleichsprofil (1) ist mit einer Klemmleiste versehen und kann so zur Wand hin verschoben werden (Abb. A).</p>	<ul style="list-style-type: none"><li>• Remove the side casing (2) and the wall compensation profile (1) from the rear panel.</li><li>• Loosen the screws (3) with the screwdriver (5) and remove them together with the washers (4) (Fig. B).</li><li>• Remove the side casing and the wall compensation profile.</li></ul> <p><b>Note:</b> </p> <p>The wall compensation profile (1) is equipped with a terminal block and can therefore be moved towards the wall (Fig. A).</p>	<ul style="list-style-type: none"><li>• Togliere il pannello laterale (2) e il profilo di compensazione a parete (1) dal pannello posteriore.</li><li>• Con il cacciavite (5) allentare e svitare le viti (3) insieme alle rondelle (4) (fig. B).</li><li>• Togliere il pannello laterale ed il profilo di compensazione a parete.</li></ul> <p><b>Avvertenza:</b> </p> <p>Il profilo di compensazione a parete (1) possiede un morsetto per poterlo spostare verso la parete (fig. A).</p>

**Seitenverkleidung abnehmen**  
**Removing the Side Casing**  
**Smontaggio del pannello laterale**



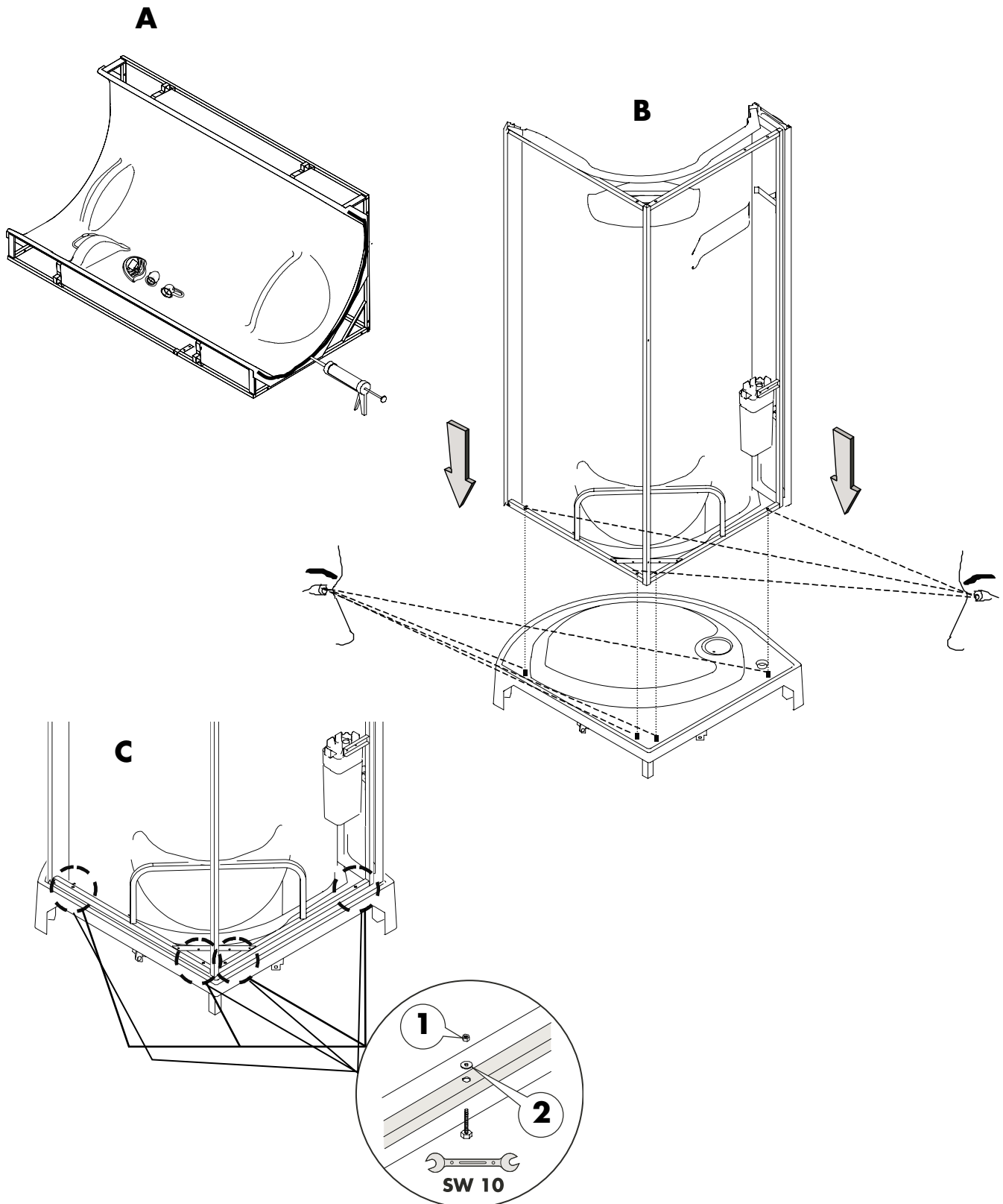

**Montage Rückwand**  
**Installing the Rear Panel**  
**Montaggio del pannello posteriore**

Deutsch	English	Italiano
<ul style="list-style-type: none"> <li>• Die Rückwand an den Einbauort bringen.</li> </ul> <p><b>Hinweis:</b> </p> <p>Die Kontaktflächen der Rückwand und Duschwanne mit einem staubfreien Tuch reinigen (Abb. A)!</p> <ul style="list-style-type: none"> <li>• Silikonraupen (<b>essigsäurefrei</b>) auf der Gesamtlänge der Kontaktfläche der Rückwand durchgehend auftragen (Abb. A)!</li> </ul> <p><b>Achtung!</b> </p> <ul style="list-style-type: none"> <li>• Die Rückwand zu zweit und sehr vorsichtig auf die Duschwanne aufsetzen (Abb. B), so dass die 4 Gewindebolzen der Duschwanne mit den 4 Bohrungen am Gestell der Rückwand übereinstimmen.</li> </ul> <ul style="list-style-type: none"> <li>• Die 4 Unterlegscheiben 6,4 x 18 (2) einsetzen und mit dem 10 mm Maulschlüssel die 4 Muttern M6 (1) mit den 4 Schrauben an der Duschwanne verschrauben (Abb. C).</li> </ul> <p><b>Hinweis:</b> </p> <p>Befestigungsschrauben der Rückwand nicht zu stark festdrehen, um Beschädigungen zu vermeiden!</p>	<ul style="list-style-type: none"> <li>• Bring the rear panel to the installation site.</li> </ul> <p><b>Note:</b> </p> <p>Clean the rear panel's contact surfaces with the shower tray using a dustfree cloth (Fig. A)!</p> <ul style="list-style-type: none"> <li>• Consistently apply silicone beads (<b>free of acetic acid</b>) to the entire length of the contact surface and the rear panel (Fig. A).</li> </ul> <p><b>Attention!</b> </p> <ul style="list-style-type: none"> <li>• The rear panel must be very carefully placed on the shower tray (Fig. B) by two persons in a way which ensures that the 4 threaded bolts of the shower tray correspond the 4 drill holes of the rear panel's framing.</li> </ul> <ul style="list-style-type: none"> <li>• Insert the 4 6.4 x 18 washers (2) and screw the 4 M6 nuts (1) to the shower tray using the four screws (Fig. C).</li> </ul> <p><b>Note:</b> </p> <p>To avoid any damage, the rear panel's fixation screws must not be secured too tightly!</p>	<ul style="list-style-type: none"> <li>• Portare il pannello posteriore sul luogo di montaggio.</li> </ul> <p><b>Avvertenza:</b> </p> <p>Pulire le superfici di contatto del pannello posteriore e della vasca della doccia con un panno pulito (fig. A)!</p> <ul style="list-style-type: none"> <li>• Applicare un tratto continuo di silicone (<b>privo di acido acetico</b>) sull'intera lunghezza della superficie di contatto e sul pannello posteriore (fig. A).</li> </ul> <p><b>Attenzione!</b> </p> <ul style="list-style-type: none"> <li>• Collocare in due il pannello posteriore sul piatto doccia con la massima cautela (fig. B), facendo corrispondere i 4 bulloni del piatto doccia con i 4 fori del telaio del pannello posteriore.</li> </ul> <ul style="list-style-type: none"> <li>• Applicare le 4 rondelle 6,4 x 18 (2) e con la chiave fissa da 10 mm avvitare i 4 dadi M6 (1) alle 4 viti del piatto doccia (fig. C).</li> </ul> <p><b>Avvertenza:</b> </p> <p>Per evitare danni, non serrare eccessivamente le viti di fissaggio!</p>



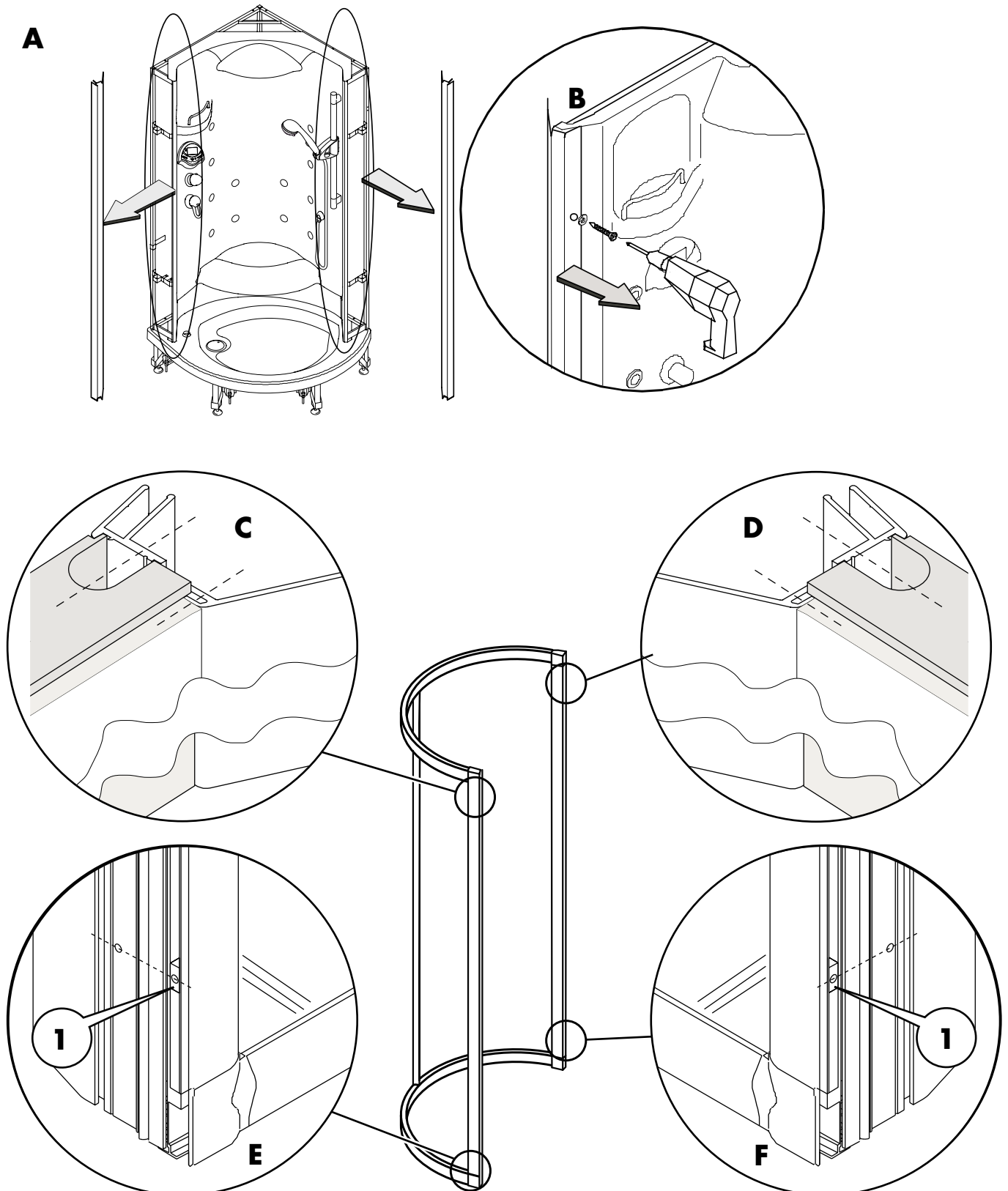

**Vorbereitung Montage Trägerrahmen**  
**Preparing the Support Frame Installation**  
**Preparativi per il montaggio del telaio**

Deutsch	English	Italiano
<ul style="list-style-type: none"> <li>• Mit einem Schraubendreher oder Akkuschauber die 4 Befestigungsschrauben herausdrehen (Abb. B).</li> <li>• Ausgleichsprofile abnehmen (Abb. A).</li> </ul> <p><b>Achtung!</b> </p> <p>Das Herausnehmen der Glaselemente aus der Verpackung muß von zwei Personen durchgeführt werden!</p> <ul style="list-style-type: none"> <li>• Die 8 Mutterneinsätze (1) in der Nut des Trägerrahmens entsprechend der Lochabstände der jeweiligen Profile ausrichten (Abb. E + F).</li> </ul> <p>Die Abkröpfung der Ausgleichsprofile (Abb. C + D) muss oben bündig zum Trägerrahmen ausgerichtet sein.</p>	<ul style="list-style-type: none"> <li>• Unscrew the 4 fixation screws using a screwdriver or an electric screwdriver (Fig. B).</li> <li>• Remove the compensation profiles (Fig. A).</li> </ul> <p><b>Attention!</b> </p> <p>Two persons are required to remove the glass elements from the packaging.</p> <ul style="list-style-type: none"> <li>• The 8 nut inserts (1) must be adjusted in the support frame's groove in accordance with the respective profiles' hole clearances (Fig. E + F).</li> </ul> <p>The top of the compensation profiles' cranks (Fig. C + D) must be aligned with the support frame.</p>	<ul style="list-style-type: none"> <li>• Con un cacciavite o un'avvitatore svitare le 4 viti di fissaggio (fig. B).</li> <li>• Togliere i profilati di compensazione (fig. A).</li> </ul> <p><b>Attenzione!</b> </p> <p>Gli elementi di vetro devono essere prelevati dall'imballaggio da due persone!</p> <ul style="list-style-type: none"> <li>• Posizionare gli 8 dadi (1) nella scanalatura del telaio secondo le distanze tra i fori dei rispettivi profilati (fig. E + F).</li> </ul> <p>La piegatura dei profilati di compensazione (figg. C + D) deve essere a filo con il telaio.</p>



**Vorbereitung Montage Trägerrahmen**  
**Preparing the Support Frame Installation**  
**Preparativi per il montaggio del telaio**

Deutsch	English	Italiano
<p><b>Abdichten:</b></p> <ul style="list-style-type: none"> <li>• Dichtung in Ausgleichsprofile einziehen und kürzen.</li> <li>• Silikonraupe (2) entlang der Dichtung auftragen.</li> <li>• Die Ausgleichsprofile (1) links und rechts auf den Trägerrahmen aufsetzen und unter Verwendung der Schrauben M4 x12 (3) festschrauben.</li> </ul> <p><b>Hinweis:</b> </p> <p>Die Schiebetüre kann auf der linken oder auf der rechten Seite eingebaut werden.</p> <p>In der Abbildung B ist die Schiebetüre links (4) platziert!          In der Abbildung C ist die Schiebetüre rechts (5) platziert!</p> <ul style="list-style-type: none"> <li>• Trägerrahmen nach Montage der Ausgleichsprofile auf Montageböcke vorsichtig ablegen, um Beschädigungen zu vermeiden (Abb. D).</li> <li>• Silikonraupe an der Unterseite des Trägerrahmens auf der gesamten Länge auftragen. (Abb. E (6)).</li> <li>• Silikonraupe am Übergang Kunststoffabdeckung / Trägerrahmen auftragen. (Abb. E (7)).</li> </ul>	<p><b>Sealing:</b></p> <ul style="list-style-type: none"> <li>• Insert the sealing in the compensation profiles and shorten them</li> <li>• Apply a silicone bead (2) to the compensation profiles.</li> <li>• Attach the compensation profiles (1) to the right and left of the support frame and secure them using the M4 x12 screws (3).</li> </ul> <p><b>Note:</b> </p> <p>The slide door can be installed on the left or right side.</p> <p>In Figure B, the slide door is positioned at the left! (4)          In Figure C, the slide door is positioned at the right! (3)</p> <ul style="list-style-type: none"> <li>• Carefully deposit the support frame on mounting blocks after the compensation profiles' installation to avoid any damage (Fig. D).</li> <li>• Apply a silicone bead to the lower side of the support frame on the whole length (Fig. E (6)).</li> <li>• Apply a silicone bead between plastic cover and support frame (Fig. E (7)).</li> </ul>	<p><b>Ermetizzazione:</b></p> <ul style="list-style-type: none"> <li>• Inserire la guarnizione nei profilati di compensazione ed accorciarla</li> <li>• Applicare un cordone di silicone (2) nel profilo compensatore.</li> <li>• Collocare i profilati di compensazione (1) a sinistra ed a destra sul telaio e serrare a fondo le viti M4 x12 (3).</li> </ul> <p><b>Avvertenza:</b> </p> <p>La porta scorrevole può essere montata a sinistra o a destra.</p> <p>In figura B la porta è situata a sinistra (4)!          In figura C la porta è situata a destra (3)!</p> <ul style="list-style-type: none"> <li>• Dopo il montaggio dei profilati di compensazione collocare il telaio con cautela sui cavalletti per evitare di danneggiarlo (fig. D).</li> <li>• Applicare un cordone di silicone nella parte inferiore della chiusura (Fig E (6)).</li> <li>• Applicare un cordone di silicone nella parte tra l'angolare ed il montante della chiusura (Fig E (7)).</li> </ul>

**A**

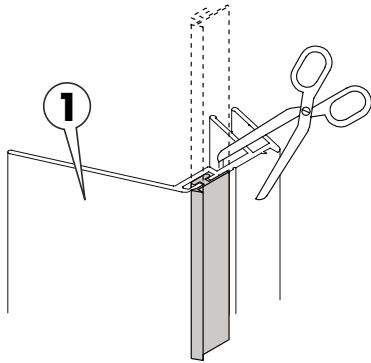

**B** Schiebetüre links  
Slide door left  
Porta scorrevole a sinistra

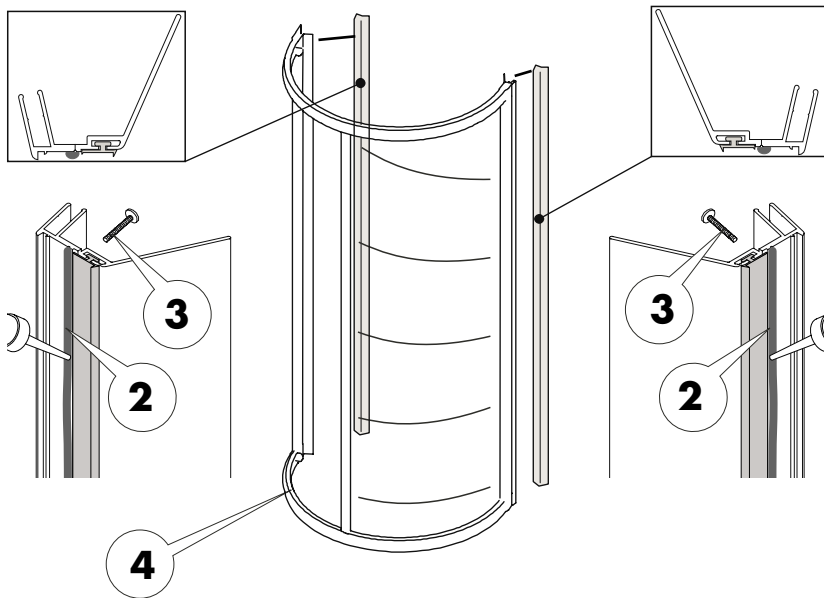

**C** Schiebetüre rechts  
Slide door right  
Porta scorrevole a destra

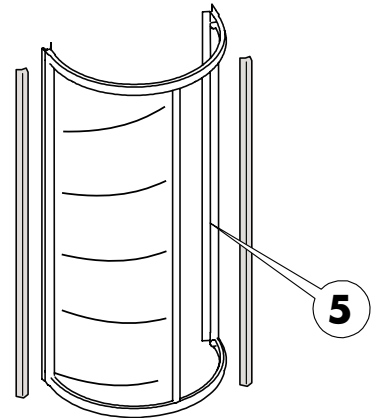



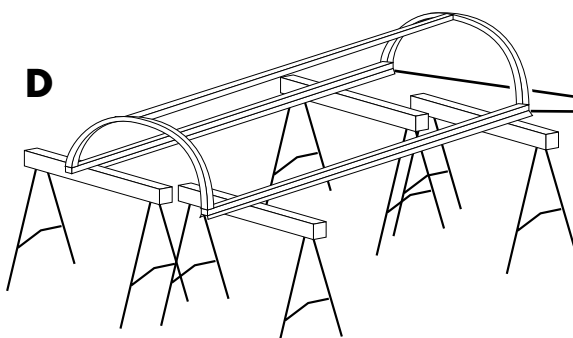

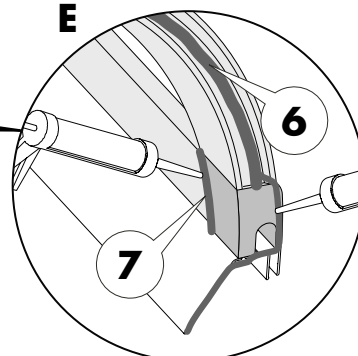

**D**



**E**







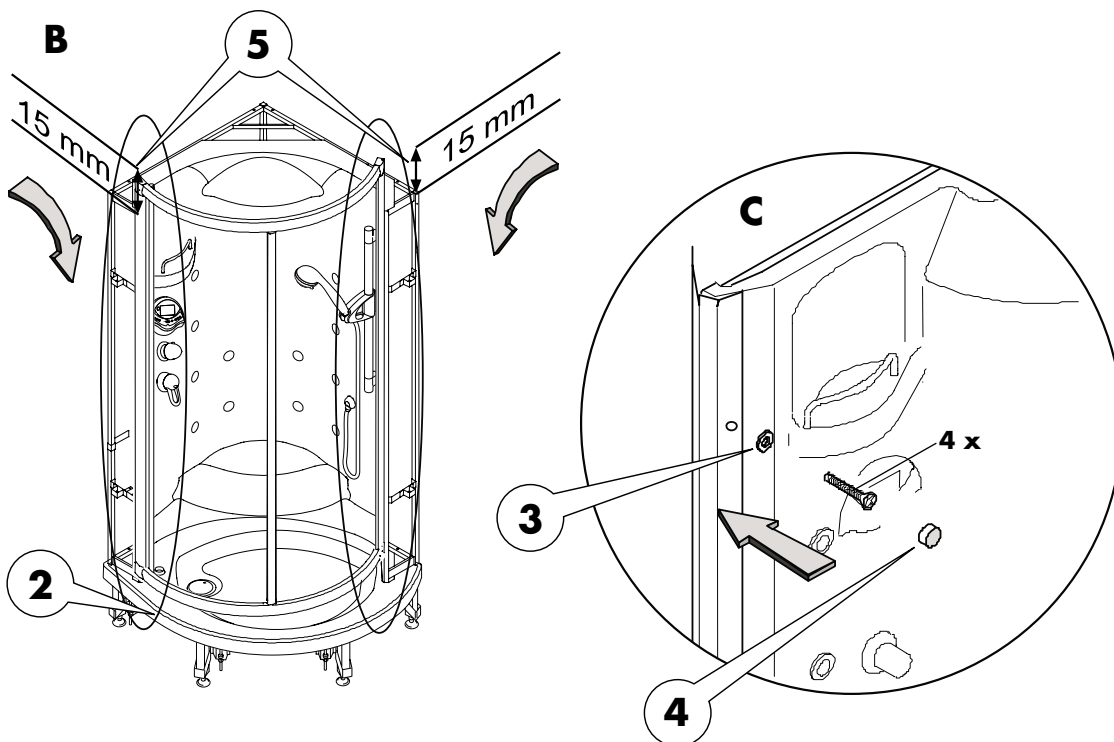
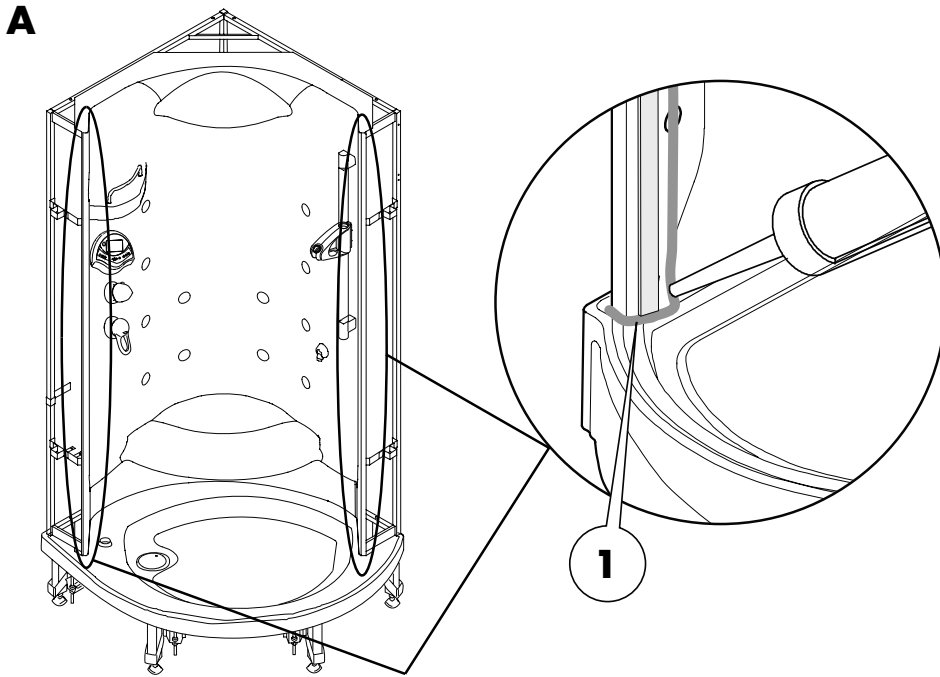



**Vorbereitung Montage Trägerrahmen**  
**Preparing the Support Frame Installation**  
**Preparativi per il montaggio del telaio**

Deutsch	English	Italiano
<p><b>Abbildung A</b></p> <ul style="list-style-type: none"> <li>• An der Rückwand entlang der Bohrlöcher und im Randbereich der Duschwanne eine Silikonraupe auftragen!</li> </ul> <p><b>Abbildung B</b></p> <p><b>Achtung!</b> </p> <p>Trägerrahmen beim Einbau leicht zusammendrücken (2) und um circa 15 mm nach oben versetzt an der Rückwand ansetzen und absenken (Abb. B)!</p> <p><b>Hinweis:</b> </p> <p>Trägerrahmen ohne Verschmieren der Silikonraupe aufsetzen! Zum Verschrauben Kunststoffdichtscheiben (3) und Abschlussdeckel (4) verwenden!</p> <ul style="list-style-type: none"> <li>• Trägerrahmen (2) mit der Rückwand an den Ausgleichsprofilen fest verschrauben (Abb. C) (Schraube 8 Stk. 16 x 4,2 V2A).</li> </ul>	<p><b>Figure A</b></p> <ul style="list-style-type: none"> <li>• Apply a silicone bead along the drilling holes of rear panel and on the border area of the shower tray!</li> </ul> <p><b>Figure B</b></p> <p><b>Attention!</b> </p> <p>Slightly press the support frame together during the installation (2), attach it to the rear panel with an offset of approx. 15 mm and then lower it (Fig. B)!</p> <p><b>Note:</b> </p> <p>The support frame must be attached without smearing the silicone bead! For screwing, use plastic sealing washers (3) and sealing covers (4)!</p> <ul style="list-style-type: none"> <li>• Tightly screw the support frame (2) to the compensation profiles together with the rear panel (Fig. C) (8 V2A 16 x 4.2 screws).</li> </ul>	<p><b>Figura A</b></p> <ul style="list-style-type: none"> <li>• Applicare un cordone di silicone su tutta l'altezza della parete in direzione dei fori presenti e tra la parete e il piatto doccia.</li> </ul> <p><b>Figura B</b></p> <p><b>Attenzione!</b> </p> <p>Durante il montaggio comprimere leggermente il telaio (2) e collocarlo ed abbassarlo sul pannello posteriore dopo averlo spostato di circa 15 mm verso l'alto (fig. B)!</p> <p><b>Avvertenza:</b> </p> <p>Collocare il telaio senza danneggiare il tratto di silicone! Per avvitare impiegare le rosette di tenuta di plastica (3) ed il tappo terminale (4)!</p> <ul style="list-style-type: none"> <li>• Avvitare il telaio (2) con il pannello posteriore ai profilati di compensazione (fig. C) (8 viti 16 x 4,2 V2A).</li> </ul>



**Schiebetür einbauen/einstellen**  
**Installing/Adjusting the Slide Door**  
**Montaggio/regolazione della porta scorrevole**





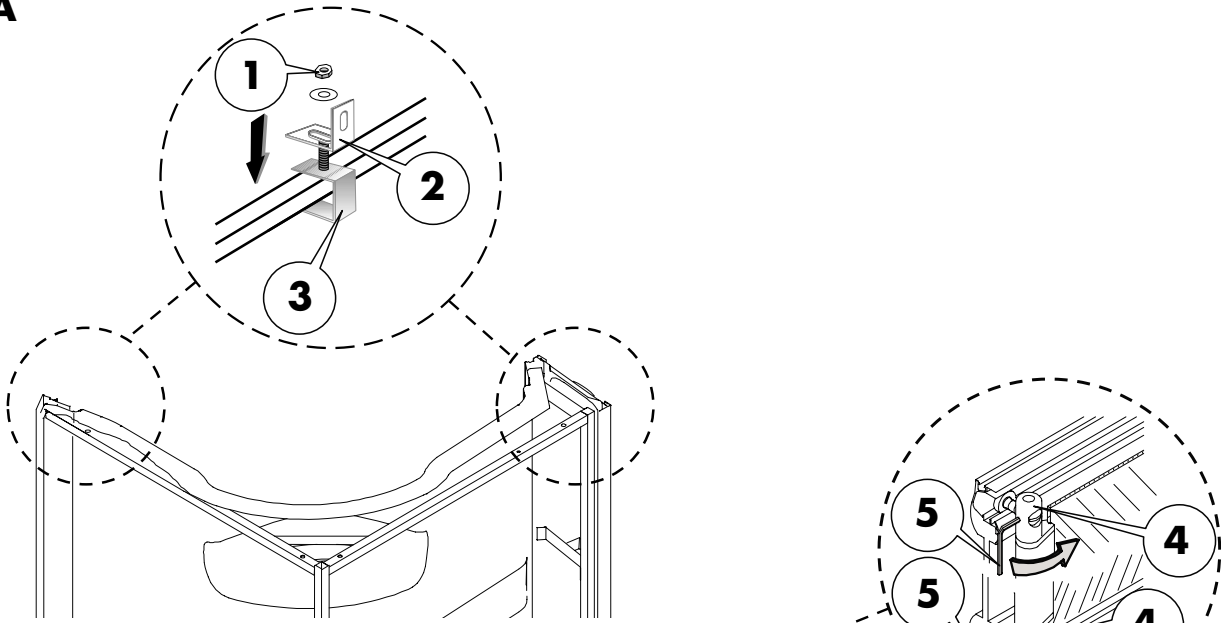

Deutsch	English	Italiano
<p><b>Befestigung:</b> Die Befestigungswinkel (2) an das C-Profil (3) der Rückwand montieren, dazu die Unterlegscheiben 6,5 x 18 und Muttern M6 (1) verwenden.</p> <p><b>Schiebetür auspacken:</b></p> <p><b>Hinweis:</b>  Die Schiebetüren (8) nicht auf den Rollen aufstützen. Die Rollen können beschädigt werden!</p> <p><b>Schiebetür einsetzen:</b> Rollen der Schiebetür (8) in das obere Profil (6) des Rahmenträgers einsetzen (Abb. B).</p> <p><b>Schiebetür grob einstellen:</b></p> <ul style="list-style-type: none"> <li>• Mit dem Inbusschlüssel (5) SW2 die 4 Gewindestifte in den Exzenterelementen (4) lösen.</li> <li>• Mit dem Schraubendreher die Exzenter-elemente (4) verdrehen, bis die unteren Rollen in das Profil des Rahmenträgers eingefahren sind. Die beiden oberen Exzenterelemente mit dem Inbusschlüssel (5) arretieren.</li> </ul> <p><b>Hinweis:</b>  Führungsschiene fetten (Abb. B).</p> <p><b>Türgriff montieren:</b> Die Türgriffe (7) montieren, dazu die 4 O-Ringe in die Nut einlegen, die Schrauben einsetzen und die Griffe festschrauben. 2 x Abschlussdeckel einsetzen.</p> <p><b>Hinweis:</b>  Türgriff außen: Befestigungsschraube unten einsetzen! Türgriff innen: Befestigungsschraube oben einsetzen!</p>	<p><b>Installation:</b> Install the angle brackets (2) to the rear panel's C-profile (3) using the 6.5 x 18 washers and M6 nuts (1).</p> <p><b>Unpacking the slide door:</b></p> <p><b>Note:</b>  The slide doors (8) must not be propped on the rollers. Otherwise, the rollers might be damaged!</p> <p><b>Inserting the slide door:</b> Insert the slide door's rollers (8) into the support frame's upper profile (6) (Fig. B).</p> <p><b>Roughly adjusting the slide door:</b></p> <ul style="list-style-type: none"> <li>• Use the SW 2 socket wrench (5) to loosen the 4 threaded pins within the eccentric elements (4).</li> <li>• Wrench the eccentric elements (4) with the screwdriver until the lower rollers are inserted into the support frame's profile. Lock the 2 upper eccentric elements with the socket wrench (5).</li> </ul> <p><b>Note:</b>  Apply some floating medium to the guide bar (Fig. B).</p> <p><b>Installing the door handles:</b> Mount the door handles (7) by placing the 4 o-rings into the groove, inserting the screws and tightening the handles. Insert 2 end covers.</p> <p><b>Note:</b>  Outside door handle: Insert the fixation screw at the bottom! Inside door handle: Insert the fixation screw at the top!</p>	<p><b>Fissaggio:</b> Montare l'angolare di fissaggio (2) al profilato a C (3) del pannello posteriore usando le rondelle 6,5 x 18 ed i dadi M6 (1).</p> <p><b>Disimballare la porta scorrevole:</b></p> <p><b>Avvertenza:</b>  Non poggiare le porte scorrevoli (8) sulle rotelle. Le rotelle possono danneggiarsi!</p> <p><b>Applicazione della porta scorrevole:</b> Introdurre le rotelle della porta scorrevole (8) nel profilato superiore (6) del telaio (fig. B).</p> <p><b>Regolazione approssimativa della porta scorrevole:</b></p> <ul style="list-style-type: none"> <li>• Con la brugola (5) da 2 allentare i 4 perni filettati negli elementi eccentrici (4).</li> <li>• Con il cacciavite ruotare gli elementi eccentrici (4) fino ad introdurre le rotelle inferiori nel profilato del telaio. Bloccare entrambi gli elementi eccentrici superiori con la brugola (5).</li> </ul> <p><b>Avvertenza:</b>  Applicare del grasso sulle guide della chiusura (fig B).</p> <p><b>Montaggio della maniglia della porta:</b> Montare le maniglie della porta (7) inserendo le 4 guarnizioni toroidali nella scanalatura, applicando le viti ed avvitando le maniglie. Applicare 2 tappi terminali.</p> <p><b>Avvertenza:</b>  Maniglia esterna: applicare la vite di fissaggio in basso! Maniglia interna: applicare la vite di fissaggio in alto!</p>

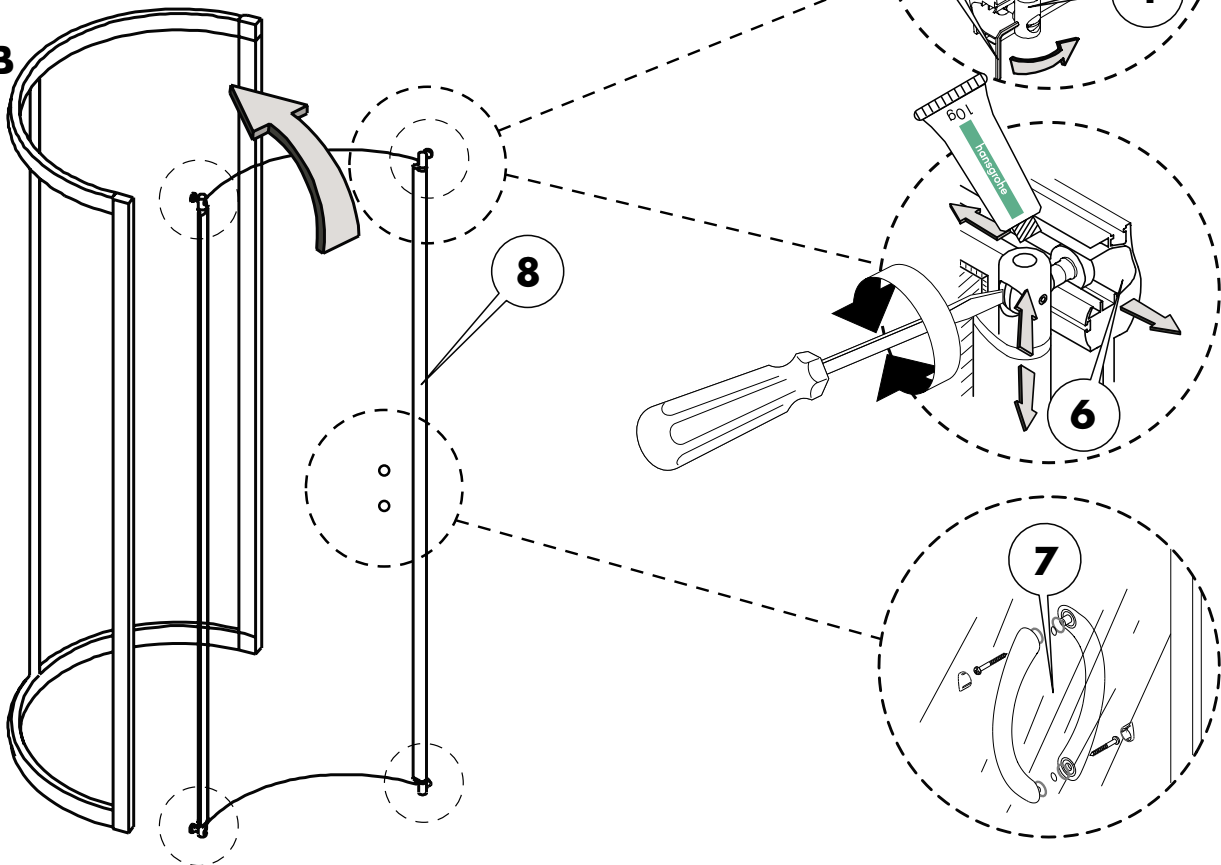
**A**







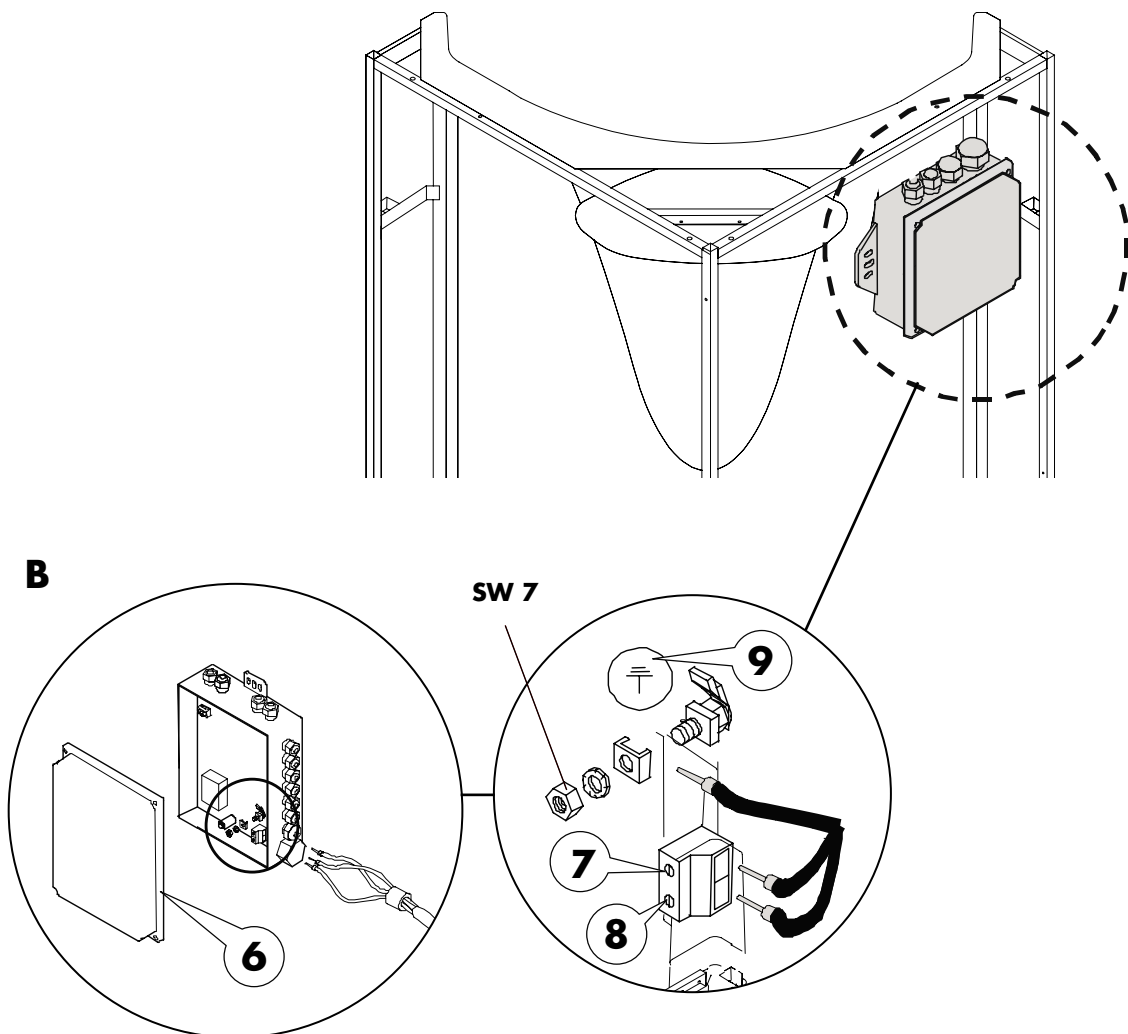

**B**



Deutsch	English	Italiano
<p><b>Elektriker!</b> </p> <p>Die elektrischen Anschlüsse dürfen ausschließlich von einem Fachmann (Elektroinstallateur) ausgeführt werden!</p> <p><b>Hinweis:</b> </p> <p>Die Erdungsmaßnahme ist nach VDE 0100 Teil 410 und Teil 540 durchzuführen.</p> <p><b>Anschluss Stromversorgung (Abb. B):</b></p> <ul style="list-style-type: none"> <li>• Den Deckel (6) der Steuerung abnehmen und die Phase (7), den Nullleiter (8) und den Erdungsanschluss (9) (Abb. B) anschließen. Die Steuerung wieder schließen und den Kabelhalter an der Steuerung anschrauben.</li> </ul>	<p><b>Electrician!</b> </p> <p>The electric connections may only be carried out by an expert (electrical installer)!</p> <p><b>Note:</b> </p> <p>The earthing measure must be carried out in accordance with VDE 0100 Part 410 and Part 540.</p> <p><b>Power supply connection (Fig. B):</b></p> <ul style="list-style-type: none"> <li>• Remove the control's cover (6) and connect the phase (7), the zero conductor (8) and the earthing connection (9) (Fig. B). Close the control and screw the cable support to the control.</li> </ul>	<p><b>Elettricista!</b> </p> <p>Il collegamento elettrico deve essere eseguito solo da un tecnico (eletttricista)!</p> <p><b>Avvertenza:</b> </p> <p>La messa a terra va eseguita a norme VDE 0100, parti 410 e 540.</p> <p><b>Allacciamento elettrico (fig. B):</b></p> <ul style="list-style-type: none"> <li>• Togliere il coperchio della centralina (6) e collegare il conduttore i fase (7), il neutro (8) e la terra (9) (fig. B). Richiudere la centralina ed avvitare il passacavo.</li> </ul>





**Montage obere Abdeckung (Dach)**  
**Installing the Top Cover**  
**Montaggio della copertura superiore**

Deutsch	English	Italiano
<ul style="list-style-type: none"> <li>• Silikon (3) oben an der Rückwand auf gesamte Länge der Dichtfläche auftragen (Abb. A).</li> <li>• Die obere Abdeckung (1) in die Nut (2) am oberen Querträger des Trägerrahmens einschieben (Abb. A). Darauf achten, dass kein Silikon verschmiert wird.</li> </ul> <p><b>Hinweis:</b> </p> <p>Die obere Abdeckung muss entlang der Kante (vorne) vollständig in die Nut eingeschoben sein.</p> <ul style="list-style-type: none"> <li>• Die obere Abdeckung (1) durch leichtes Andrücken fixieren und an den vorgegebenen 10 Punkten (4) mit einem 2 mm Bohrer von unten Löcher durch Rückwand (6) und obere Abdeckung (1) bohren. Von oben mit selbstbohrende Schrauben (5) obere Abdeckung (1) mit der Rückwand (6) verschrauben.</li> <li>• Gummidichtung an der Türrahmenunterseite einsetzen. Überstand mit dem Messer abschneiden (Abb. A).</li> <li>• Die Kabine ist am unteren Querprofil rechts und links des Trägergestells von außen und innen mit Silikon abzudichten! Es muss mindestens bis auf die Höhe des Wannerrandes mit Silikon (7) abgedichtet werden (Abb. C).</li> <li>• Der Zwischenraum hinter dem Nutprofil, in der die Seitenverkleidung eingesteckt wird, ist bis auf die Höhe von 100 mm mit Silikon zu verfüllen.</li> </ul> <p><b>Hinweis:</b> </p> <p>Zwischen der ersten Nut und dem Querträger ist der gesamte Bereich mit Silikon ca. 40 mm hoch abzudichten (Abb. C).</p> <ul style="list-style-type: none"> <li>• Stopfen an Türrahmen montieren (Abb. D).</li> </ul>	<ul style="list-style-type: none"> <li>• Apply silicone (3) to the rear panel's top over the sealing surface's entire length (Fig. A).</li> <li>• Insert the top cover (1) into the groove (2) of the support frame's upper crossbar (Fig. A). Assure that no silicone is smeared.</li> </ul> <p><b>Note:</b> </p> <p>The top cover must be completely inserted into the groove along the edge (front).</p> <ul style="list-style-type: none"> <li>• Fixate the top cover (1) by slightly pressing it down and use a 2 mm drill to drill holes through the rear panel (6) and the top cover (1) from beneath at the 10 specified points (4). Use self-drilling screws (5) to screw the top cover (1) to the rear panel (6).</li> <li>• Insert the rubber sealing at the door frame's bottom side. Remove any overhang with a knife (Fig. A).</li> <li>• The cabin must be sealed with silicone at the support framing's right and left bottom cross bar from the outside and inside! The silicone sealing must at least be drawn to the tray edge's height (7) (Fig. C D).</li> <li>• The clearance behind the groove profile in which the side casing is plugged into must be filled with silicone up to a height of 100 mm.</li> </ul> <p><b>Note:</b> </p> <p>The entire area between the first groove and the crossbar must be sealed with silicone up to a height of approx. 40 mm (Fig. C).</p> <ul style="list-style-type: none"> <li>• Install covers at door panel (Abb. D).</li> </ul>	<ul style="list-style-type: none"> <li>• Applicare silicone (3) in alto sull'intera lunghezza della superficie di tenuta (fig. A).</li> <li>• Inserire la copertura superiore (1) nella scanalatura (2) della traversa superiore del telaio (fig. A). Attenzione a non imbrattare di silicone.</li> </ul> <p><b>Avvertenza:</b> </p> <p>La copertura superiore deve essere completamente inserita nella scanalatura lungo il bordo (anteriore).</p> <ul style="list-style-type: none"> <li>• Fissare la copertura superiore (1) premendola leggermente e con una punta da 2 mm praticare dal basso fori attraverso il pannello posteriore (6) e la copertura superiore (1) in corrispondenza dei 10 punti previsti (4). Con le viti autofilettanti (5) avvitare dall'alto la copertura superiore (1) al pannello posteriore (6).</li> <li>• Applicare la guarnizione di gomma sul lato inferiore del telaio della porta. Tagliare l'eccesso con il coltello (fig. A).</li> <li>• Il profilato trasversale inferiore del telaio della cabina deve essere ermetizzato dall'esterno con silicone! Si deve ermetizzare con silicone (7) almeno fino all'altezza del bordo del piatto doccia (figg. C + D).</li> <li>• L'intercapedine dietro il profilato scanalato in cui si inserisce il pannello laterale va riempita con silicone fino all'altezza di 100 mm.</li> </ul> <p><b>Avvertenza:</b> </p> <p>Tra la prima scanalatura e la traversa, l'intera area va ermetizzata con silicone per un'altezza di circa 40 mm (fig. C).</p> <ul style="list-style-type: none"> <li>• Installare il tappo nell'anta fissa (Fig. D).</li> </ul>

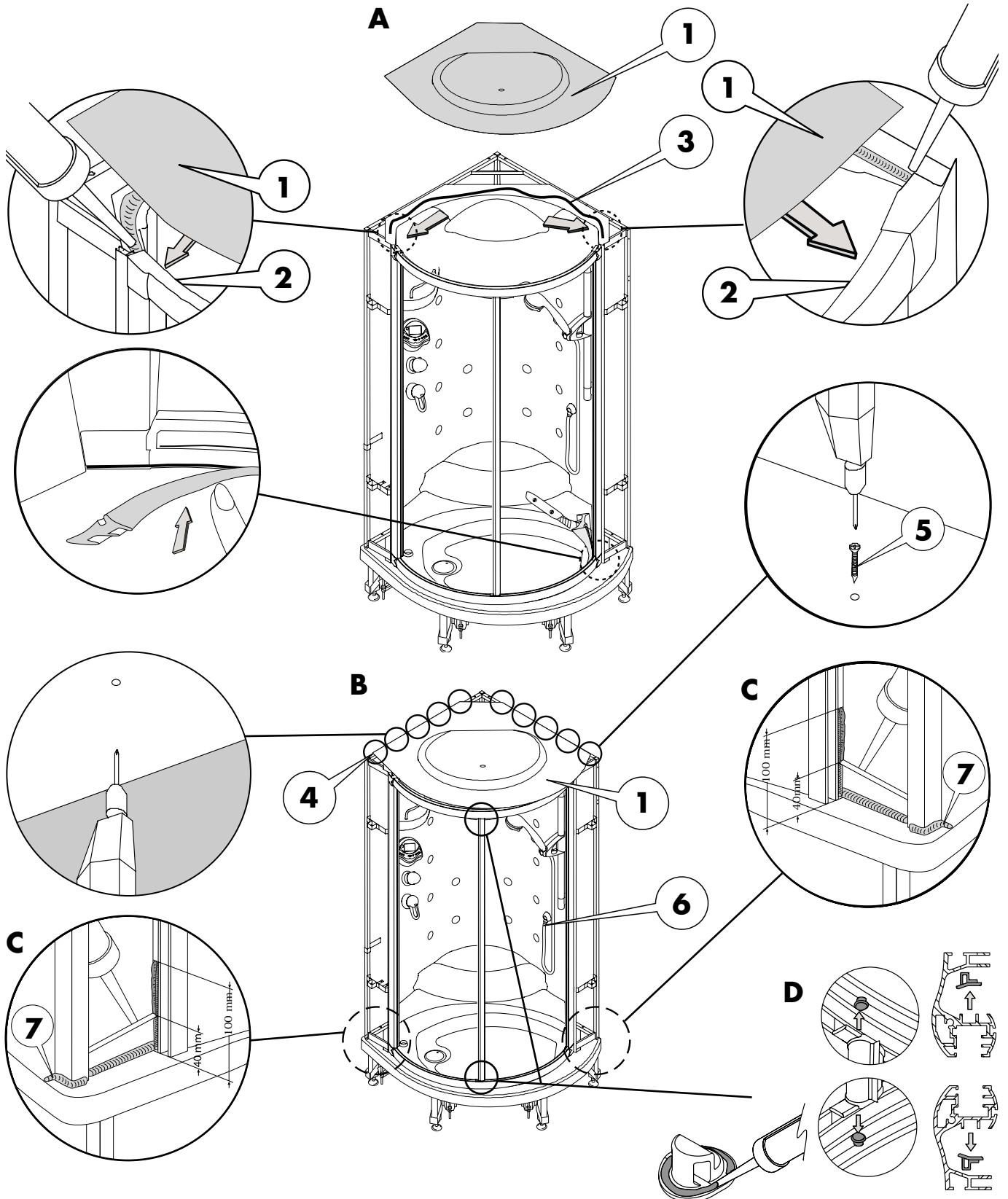
**Montage obere Abdeckung (Dach)**  
**Installing the Top Cover**  
**Montaggio della copertura superiore**



**Anschluss Beleuchtung/Lautsprecher**  
**Connecting the Illumination/Loudspeaker**  
**Collegamento dell'illuminazione/altoparlante**

Deutsch	English	Italiano
<p><b>Elektriker!</b> </p> <p><b>Anschluss Beleuchtung (1):</b>            (nur Variante Deluxe)            Den Stecker von der Beleuchtung mit dem Dosenstecker verbinden</p> <p><b>Anschluss Lautsprecher (2):</b>            (nur Variante Deluxe)            Stecker des Lautsprechers mit Lautsprecher verbinden</p>	<p><b>Electrician!</b> </p> <p><b>Connecting the illumination (1):</b>            (only Deluxe version)            Connect the illumination plug with the socket plug.</p> <p><b>Connecting the loudspeaker (2):</b>            (only Deluxe version)            Connect the loudspeaker plug with the loudspeaker.</p>	<p><b>Elektricista!</b> </p> <p><b>Collegamento dell'illuminazione (1):</b>            (solo versione Deluxe)            Collegare la spina dell'illuminazione alla presa.</p> <p><b>Collegamento dell'altoparlante (2):</b>            (solo versione Deluxe)            Collegare la spina dell'altoparlante all'altoparlante.</p>

**Anschluss Beleuchtung/Lautsprecher**  
**Connecting the Illumination/Loudspeaker**  
**Collegamento dell'illuminazione/altoparlante**

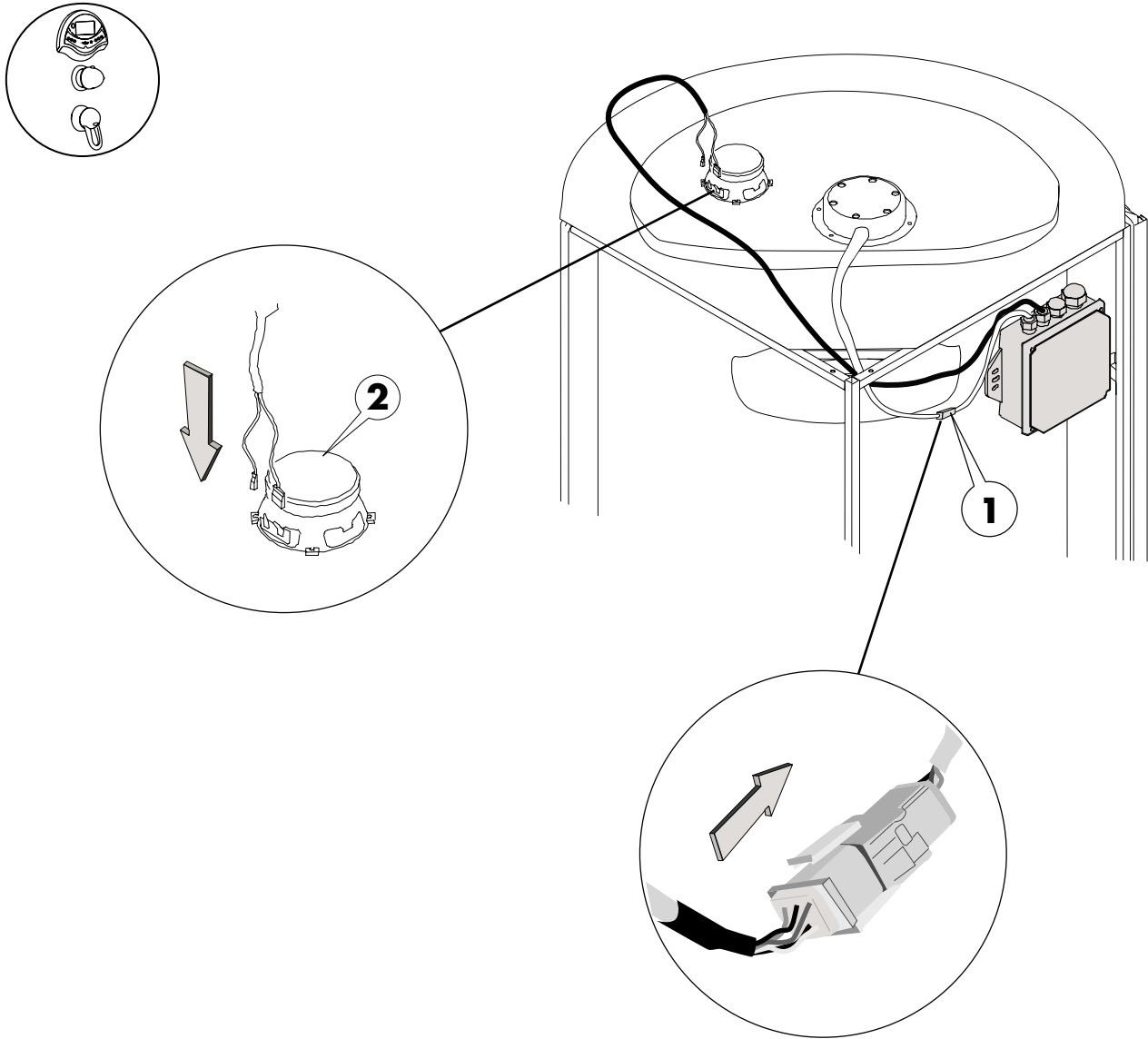





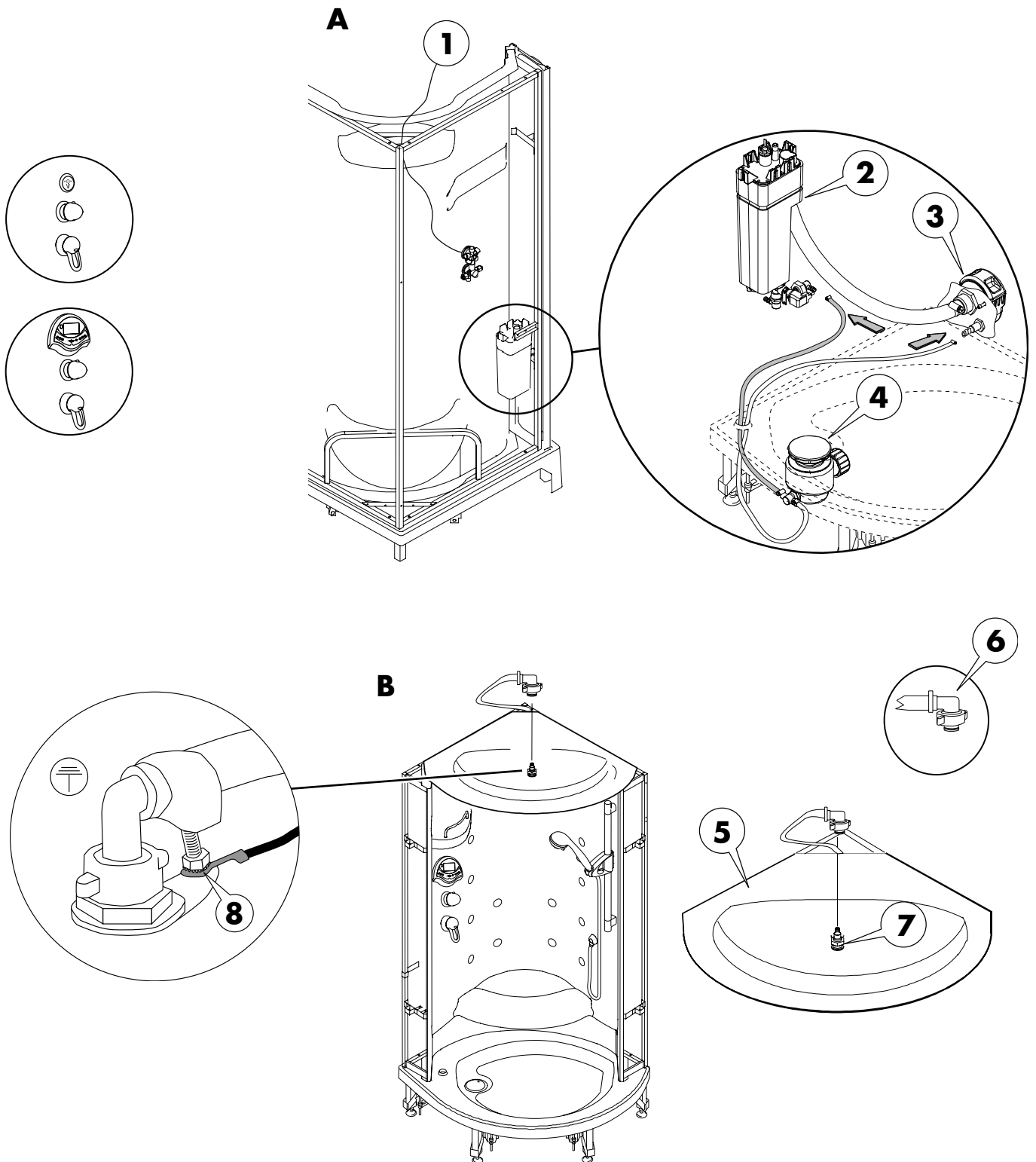

**Montage Verbindungsschläuche/Kopfbrause**  
**Installing the Connection Tubes/Head Shower**  
**Montaggio dei tubi flessibili di raccordo/soffione doccia**

Deutsch	English	Italiano
<p><b>A. Anschluss Dampfdusche:</b></p> <ul style="list-style-type: none"> <li>• Verbindungsschlauch auf 680 mm kürzen, durch die Öffnung in der Duschwanne führen, zwischen Ablauf (4) und Dampfgerät (2) aufstecken und mit den Schlauchschellen sichern.</li> <li>• Verbindungsschlauch auf 680 mm kürzen, durch die Öffnung in der Duschwanne führen, zwischen Ablauf (4) und Dampfdüse (3) aufstecken und mit den Schlauchschellen sichern.</li> </ul> <p><b>A. + B. Anschluss Kopfbrause:</b></p> <ul style="list-style-type: none"> <li>• Erdungsanschluß (8) am Gewindestück (7) der Kopfbrause verschrauben.</li> <li>• Verbindungsschlauch von Mischer (1) zur oberen Abdeckung (5) verlegen (mit Kabelbinder fixieren).</li> <li>• Anschlußstück (6) des Verbindungsschlauches mit dem Gewindestück (7) der Kopfbrause verschrauben.</li> </ul>	<p><b>A. Connecting the steam shower:</b></p> <ul style="list-style-type: none"> <li>• Shorten the connection tube to 680 mm, route it through the shower tray's opening, plug it between the drain (4) and the steam device (2) and secure it using tube clips.</li> <li>• Shorten the connection tube to 680 mm, route it through the shower tray's opening, plug it between the drain (4) and the steam nozzle (3) and secure it using tube clips.</li> </ul> <p><b>A. + B. Connecting the head shower:</b></p> <ul style="list-style-type: none"> <li>• Screw the earthing connection (8) at the head shower's threaded piece (7).</li> <li>• Run the connection tube from the mixer (1) to the top cover (5) (secure with cable ties).</li> <li>• Screw the connection tube's fitting piece (6) to the head threaded part (7).</li> </ul>	<p><b>A. Collegamento della doccia di testa:</b></p> <ul style="list-style-type: none"> <li>• Accorciare il tubo flessibile di raccordo alla misura di 680 mm, condurlo attraverso l'apertura del piatto doccia, collegarlo tra lo scarico (4) e l'apparecchio del vapore (2) e fissarlo con le fascette stringitubo.</li> <li>• Accorciare il tubo flessibile di raccordo alla misura di 680 mm, condurlo attraverso l'apertura del piatto doccia, collegarlo tra lo scarico (4) e l'ugello del vapore (3) e fissarlo con le fascette stringitubo.</li> </ul> <p><b>A. + B. Collegamento del soffione doccia:</b></p> <ul style="list-style-type: none"> <li>• Avvitare il cavo di terra (8) all'elemento filettato (7) del soffione doccia.</li> <li>• Posare il tubo flessibile di raccordo dal miscelatore (1) alla copertura superiore (5) (fissare con serracavo).</li> <li>• Avvitare il raccordo (6) del tubo flessibile di raccordo all'elemento filettato (7) della doccia di testa.</li> </ul>







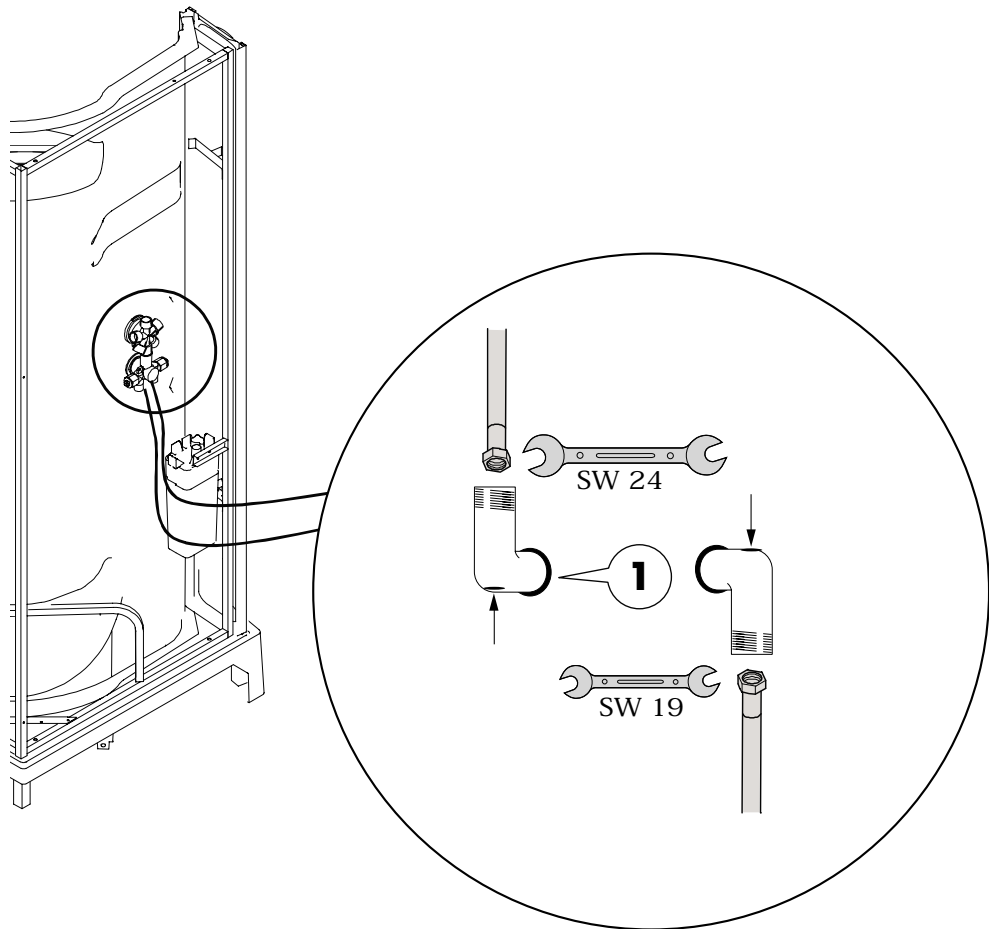

**Montage Verbindungsschläuche/Kopfbrause**  
**Installing the Connection Tubes/Head Shower**  
**Montaggio dei tubi flessibili di raccordo/soffione doccia**



Deutsch	English	Italiano
<p><b>Hinweis:</b> </p> <p><b>Abwasseranschlüsse verbinden!</b></p> <ul style="list-style-type: none"> <li>• Hauptwasserzufuhr schließen.</li> <li>• Anschlusswinkel (1) abdichten und mit Maulschlüssel SW 19 eindrehen.</li> <li>• Hauptwasserzufuhr öffnen und Anschlußwinkel auf Dichtheit prüfen.</li> <li>• Wasserschläuche an die Abschlusswinkel (1) anschrauben und mit Maulschlüssel SW 24 festdrehen.</li> </ul> <p><b>Hinweis:</b> </p> <p>Nur absperrbare Abschlusswinkel (1) einsetzen (Bestandteil der Lieferung)!</p>	<p><b>Note:</b> </p> <p><b>Closing the effluent connections!</b></p> <ul style="list-style-type: none"> <li>• Close the main water supply.</li> <li>• Seal the angle cleats (1) and screw it in using an SW 19 wrench.</li> <li>• Open the main water supply and check the angle cleats for tightness.</li> <li>• Screw the water tubes to the angle cleats (1) and secure them with an SW 24 wrench.</li> </ul> <p><b>Note:</b> </p> <p>Only lockable angle cleats (1) may be used (included in delivery)!</p>	<p><b>Avvertenza:</b> </p> <p><b>Chiudere la connessione alla rete idrica!</b></p> <ul style="list-style-type: none"> <li>• Collegare il tubo di mandata principale dell'acqua.</li> <li>• Ermetizzare la curva di raccordo (1) ed avvitare con la chiave fissa da 19.</li> <li>• Aprire la mandata d'acqua e controllare la tenuta della curva.</li> <li>• Avvitare i tubi flessibili dell'acqua alle curve di raccordo (1) e serrare a fondo con la chiave fissa da 24.</li> </ul> <p><b>Avvertenza:</b> </p> <p>Impiegare solo curve chiudibili (1) (fornite in dotazione)!</p>









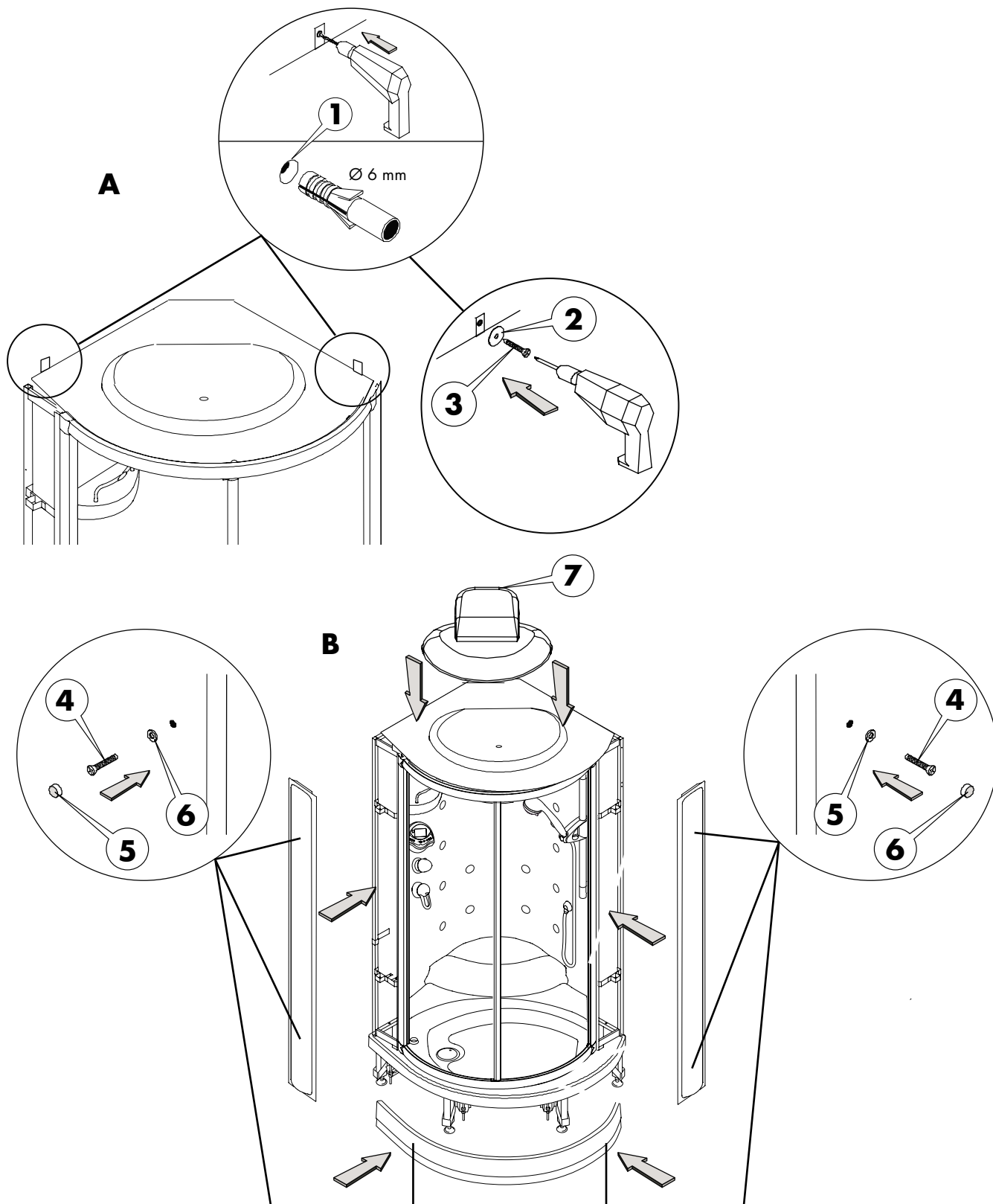

# Montage Dampfdusche/Dachabdeckung/Seitenverkleidung Installing the Steam Shower/Roof Cover/Side Casing Montaggio della doccia a vapore/copertura del tetto/pannello laterale

Deutsch	English	Italiano
<p><b>Hinweis:</b> </p> <p>Vor dem Einbau der Dampfdusche muss eine Druckprüfung durchgeführt werden!</p> <p><b>Druckprüfung:</b></p> <ul style="list-style-type: none"> <li>• Sämtliche Schlauch- und Rohrverbindungen auf korrekten Sitz prüfen.</li> <li>• Kalt- und Warmwasserzulauf öffnen.</li> <li>• Schlauch- und Rohrverbindungen optisch auf Undichtigkeit prüfen.</li> <li>• Undichte Anschlüsse oder Verbindungen abdichten.</li> </ul> <p><b>Befestigung (Abb. A):</b></p> <p><b>Vorsicht!</b> </p> <p>Stromschlag oder Wasseraustritt. Beim Bohren auf Strom- und Wasserleitungen achten!</p> <ul style="list-style-type: none"> <li>• Dampfdusche in die Einbauposition bringen und Abwasserleitung anschliessen.</li> </ul> <p><b>Hinweis:</b> </p> <p>Beim Bohren: Absaugung verwenden! Ausrichtung der Dampfdusche in die senkrechte (Wasserwaage: senkrechter Stand)!</p> <ul style="list-style-type: none"> <li>• Befestigungsbohrungen mit <math>\varnothing</math> 6 mm ausführen (1) und Dübel mit <math>\varnothing</math> 6 mm einsetzen.</li> </ul> <p><b>Befestigung (Abb. B):</b></p> <ul style="list-style-type: none"> <li>• Mit Befestigungsschrauben (3), 4 x 40 mm die endgültige Position fixieren. Unterlegscheiben (2) 4,3 x 16 mm verwenden.</li> <li>• Folie von Seitenblenden und Wannenschürze entfernen</li> <li>• Seitenverkleidung und Wannenschürze mit selbstbohrenden Schrauben (4) 4 x 24 mm und Kunststoffdichtscheiben (6) befestigen. Abdeckkappen (5) aufsetzen. Deckel (7) auf obere Abdeckung aufsetzen.</li> </ul>	<p><b>Note:</b> </p> <p>A pressure test must be carried out before installing the steam shower!</p> <p><b>Pressure test:</b></p> <ul style="list-style-type: none"> <li>• Check all tube and pipe connections for proper fit.</li> <li>• Open the cold and warm water intake.</li> <li>• Optically inspect the tube and pipe connections for untightness.</li> <li>• Seal any untight connections.</li> </ul> <p><b>Fixation (Fig. A):</b></p> <p><b>Caution!</b> </p> <p>Electric shock or water emergence. Observe all current and water lines when drilling!</p> <ul style="list-style-type: none"> <li>• Place the steam shower in its mounting position and connect the drains.</li> </ul> <p><b>Note:</b> </p> <p>When drilling: Use extraction! Position the steam shower vertically (water level: vertical application)!</p> <ul style="list-style-type: none"> <li>• Drill fixation holes of <math>\varnothing</math> 6 mm (1) and insert <math>\varnothing</math> 6 mm plugs.</li> </ul> <p><b>Fixation (Fig. B):</b></p> <ul style="list-style-type: none"> <li>• Fixate the final position using 4 x 40 fixation screws (3). Use 4.3 x 16 mm washers (2).</li> <li>• Replace the foil from the side panes and the tray skirt.</li> <li>• Fixate the side casing and the tray skirt using 4 x 24 mm self-drilling screws (4) and plastic sealing washers (6). Attach the cover caps (5). Attach the cover (7) to the upper casing.</li> </ul>	<p><b>Avvertenza:</b> </p> <p>Prima di montare la doccia a vapore è necessario eseguire la prova in pressione!</p> <p><b>Prova in pressione:</b></p> <ul style="list-style-type: none"> <li>• Controllare la stabilità dei raccordi dei tubi rigidi e flessibili.</li> <li>• Aprire la mandata dell'acqua fredda e calda.</li> <li>• Controllare visivamente la tenuta dei raccordi dei tubi rigidi e flessibili.</li> <li>• Ermetizzare i raccordi che perdono.</li> </ul> <p><b>Fissaggio (fig. A):</b></p> <p><b>Cautela!</b> </p> <p>Folgorazione o perdite d'acqua. Nel praticare i fori attenzione a non danneggiare linee elettriche ed idriche!</p> <ul style="list-style-type: none"> <li>• Portare la doccia a vapore in posizione di montaggio e collegare il tubo di scarico.</li> </ul> <p><b>Avvertenza:</b> </p> <p>Per praticare i fori impiegare un sistema di aspirazione!</p> <p>Posizionare verticalmente la doccia a vapore (livella a bolla d'aria verticale)!</p> <ul style="list-style-type: none"> <li>• Praticare i fori di fissaggio con una punta <math>\varnothing</math> 6 mm (1) e applicare tasselli <math>\varnothing</math> 6 mm.</li> </ul> <p><b>Fissaggio (fig. B):</b></p> <ul style="list-style-type: none"> <li>• Fissare nella posizione definitiva con le viti (3) 4 x 40 mm. Impiegare le rondelle (2) 4,3 x 16 mm.</li> <li>• Togliere la pellicola dai rivestimenti laterali e dalla copertura dello zoccolo della vasca.</li> <li>• Fissare il pannello laterale e la copertura dello zoccolo della vasca con le viti automaschianti 4 x 24 mm (4) e con le rondelle di tenuta di plastica (6). Applicare i tappi (5). Applicare il coperchio (7) sulla copertura superiore.</li> </ul>

**Montage Dampfdusche/Dachabdeckung/Seitenverkleidung**  
**Installing the Steam Shower/Roof Cover/Side Casing**  
**Montaggio della doccia a vapore/copertura del tetto/pannello laterale**



**Schiebetür einstellen**  
**Adjusting the Slide Door**  
**Regolazione della porta scorrevole**

Deutsch	English	Italiano
<p><b>Schiebetür einstellen:</b></p> <ul style="list-style-type: none"> <li>• Mit dem Inbusschlüssel SW 2 die 2 Gewindestifte in den oberen Exzenterelementen lösen.</li> <li>• Türanschlag mit einem Schraubendreher über die Exzenterbolzen (1) oben und unten einstellen.</li> </ul> <p><b>Hinweis:</b> </p> <p>Einstellung von innen bei geschlossener Schiebetür durchführen.</p> <ul style="list-style-type: none"> <li>• Mit dem Inbusschlüssel SW 2 (3) die 4 Stifte in den Exzenterelementen (2) fixieren.</li> </ul> <p><b>Hinweis:</b> </p> <p>Die Schiebetür muss an der Anschlagseite auf der gesamten Länge exakt schließen!</p> <ul style="list-style-type: none"> <li>• Die Schrägstellung der Schiebetür kann durch die Verstellung des Exzenterbolzens (2) mit dem Inbusschlüssel SW 2 eingestellt werden!</li> <li>• Mit dem Inbusschlüssel SW 2 die 4 Gewindestifte in den Exzenterelementen wieder fixieren.</li> <li>• Mit einem stumpfen Gegenstand die Dichtlippe (4) auf die Innenseite der Duschkabine bringen (Abb. C).</li> </ul> <p><b>Hinweis:</b> </p> <p>Die Dichtlippen müssen korrekt anliegen!</p>	<p><b>Adjusting the slide door:</b></p> <ul style="list-style-type: none"> <li>• Loosen the two threaded pins in the upper eccentric elements using the SW 2 socket wrench.</li> <li>• Adjust the top and bottom door hinge via the eccentric bolts (1) using a screwdriver.</li> </ul> <p><b>Note:</b> </p> <p>The inside adjustment must be carried out with the slide door closed.</p> <ul style="list-style-type: none"> <li>• Fixate the four pins in the eccentric elements (2) using the SW 2 socket wrench (3).</li> </ul> <p><b>Note:</b> </p> <p>The slide door must accurately close over the entire length of its hinge side!</p> <ul style="list-style-type: none"> <li>• The tilted position of the slide door can be adjusted by adjusting the eccentric bolt (2) with the SW 2 socket wrench!</li> <li>• Re-fixate the four threaded pins in the eccentric elements using the SW 2 socket wrench.</li> <li>• Force the sealing lip (4) to the shower cabin's inside using a blunt object (Fig. C).</li> </ul> <p><b>Note:</b> </p> <p>The sealing lips must be correctly applied!</p>	<p><b>Regolazione della porta scorrevole:</b></p> <ul style="list-style-type: none"> <li>• Con la brugola da 2 allentare i 2 perni filettati degli elementi eccentrici superiori.</li> <li>• Con un cacciavite regolare in alto ed in basso la battuta della porta agendo sui perni eccentrici (1).</li> </ul> <p><b>Avvertenza:</b> </p> <p>Eseguire la regolazione dall'interno solo a porta scorrevole chiusa.</p> <ul style="list-style-type: none"> <li>• Con la brugola da 2 (3) fissare i 4 perni degli elementi eccentrici (2).</li> </ul> <p><b>Avvertenza:</b> </p> <p>Sul lato di battuta, la porta scorrevole deve chiudere esattamente per l'intera lunghezza!</p> <ul style="list-style-type: none"> <li>• L'inclinazione della porta scorrevole può essere regolata agendo sul perno eccentrico (2) con la brugola da 2!</li> <li>• Con la brugola da 2 rifissare i 4 perni filettati negli elementi eccentrici.</li> <li>• Con un oggetto smussato portare il labbro di tenuta (4) sul lato interno della cabina doccia (fig. C).</li> </ul> <p><b>Avvertenza:</b> </p> <p>I labbri di tenuta devono essere correttamente a contatto!</p>

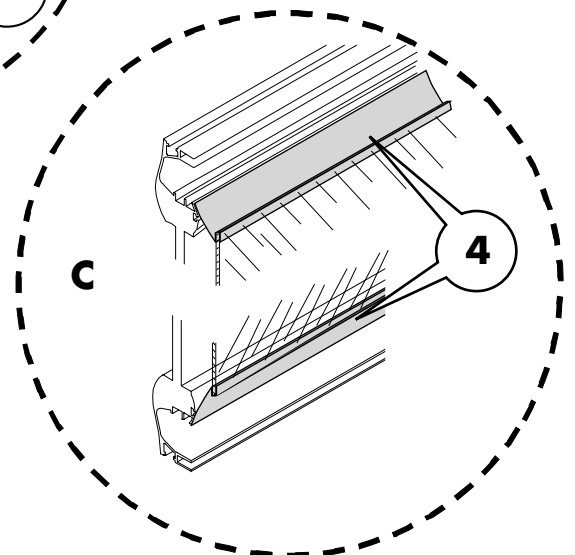
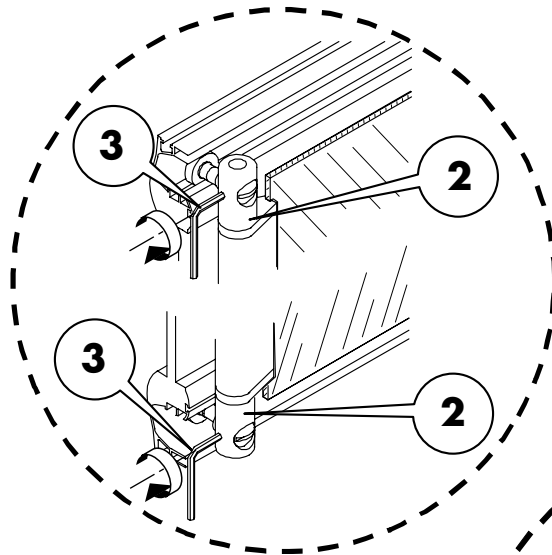
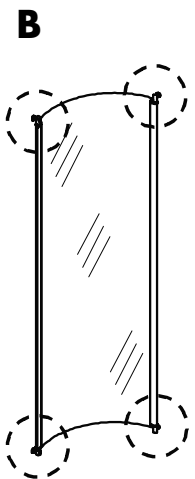
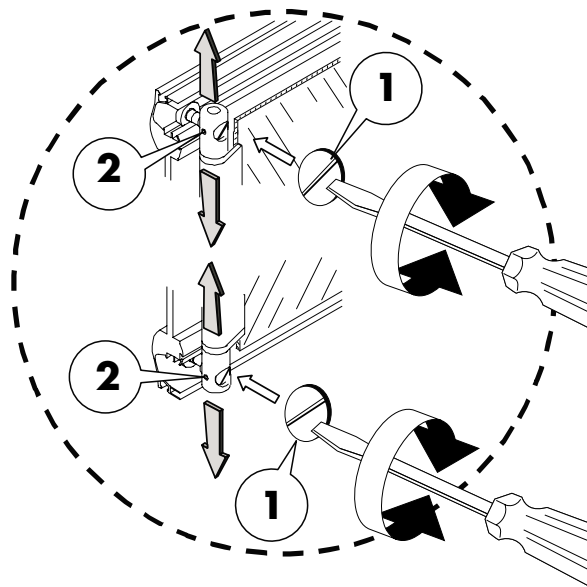
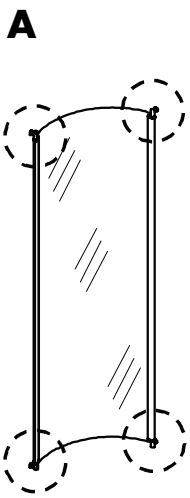



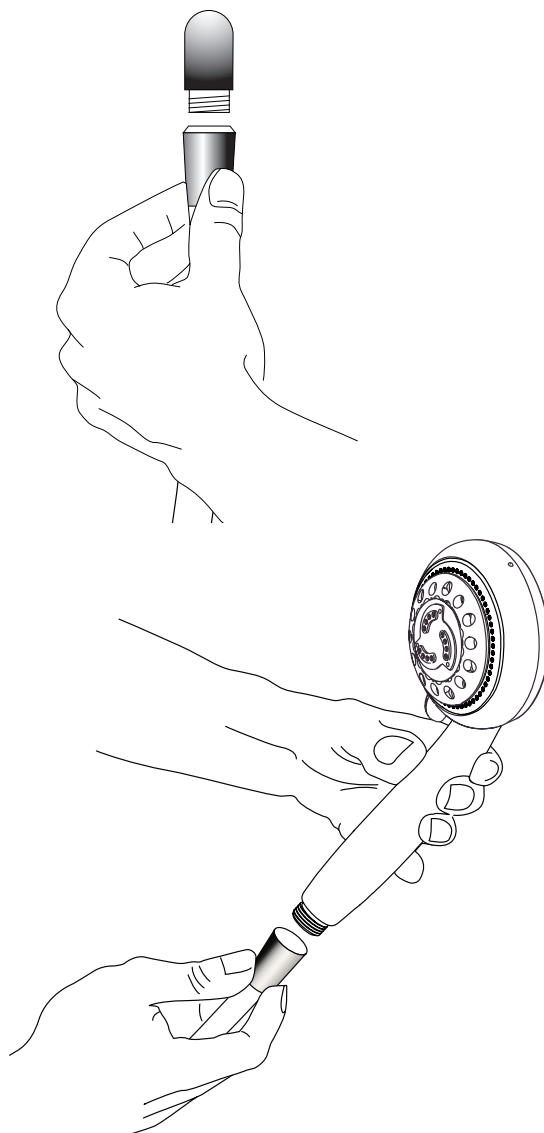
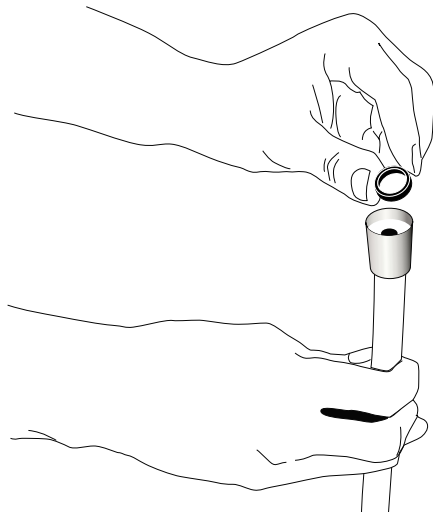
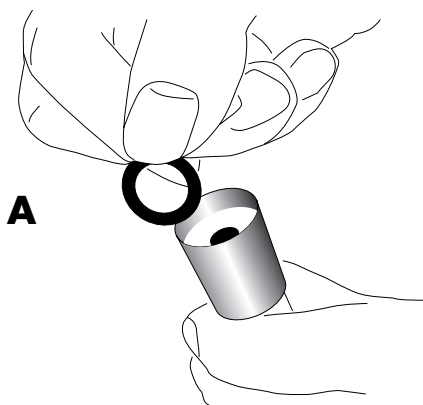
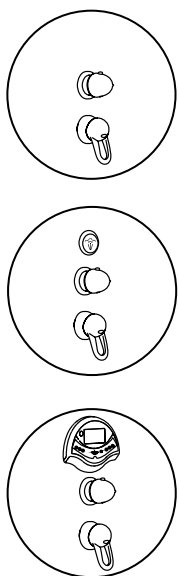

**Montage Schlauch/Handbrause**  
**Installing the Tube/Hand Shower**  
**Montaggio del tubo flessibile/doccia manuale**

Deutsch	English	Italiano
<p><b>Abbildung A:</b></p> <ol style="list-style-type: none"> <li>1. Dichtring in den Brauseschlauch zum Wandanschluss einsetzen.</li> <li>2. Brauseschlauch an den Wandanschluss anschließen.</li> <li>3. Dichtring in den Brauseschlauch zur Handbrause einsetzen.</li> <li>4. Brauseschlauch an die Handbrause anschließen.</li> </ol> <p><b>Abbildung B:</b></p> <p>Das Schiebeelement (Wandstange) kann durch Drehen der Einstellschraube schwer- oder leichtgängiger eingestellt werden.</p>	<p><b>Figure A:</b></p> <ol style="list-style-type: none"> <li>1. Insert the sealing ring into the shower tube facing the wall connection.</li> <li>2. Connect the shower tube to the wall connection.</li> <li>3. Insert the sealing ring into the shower tube for the hand shower.</li> <li>4. Connect the shower tube to the hand shower.</li> </ol> <p><b>Figure B:</b></p> <p>The slide element (wall bar) can be regulated to be either hard or easily adjustable by turning the adjusting screw.</p>	<p><b>Figura A:</b></p> <ol style="list-style-type: none"> <li>1. Applicare la guarnizione di tenuta nel tubo flessibile della doccia verso il raccordo a parete.</li> <li>2. Collegare il tubo flessibile della doccia al raccordo a parete.</li> <li>3. Applicare la guarnizione di tenuta nel tubo flessibile verso la doccia.</li> <li>4. Collegare il tubo flessibile alla doccia manuale.</li> </ol> <p><b>Figura B:</b></p> <p>La scorrevolezza dell'elemento scorrevole (sbarra da parete) può essere regolato agendo sulla vite di registro.</p>

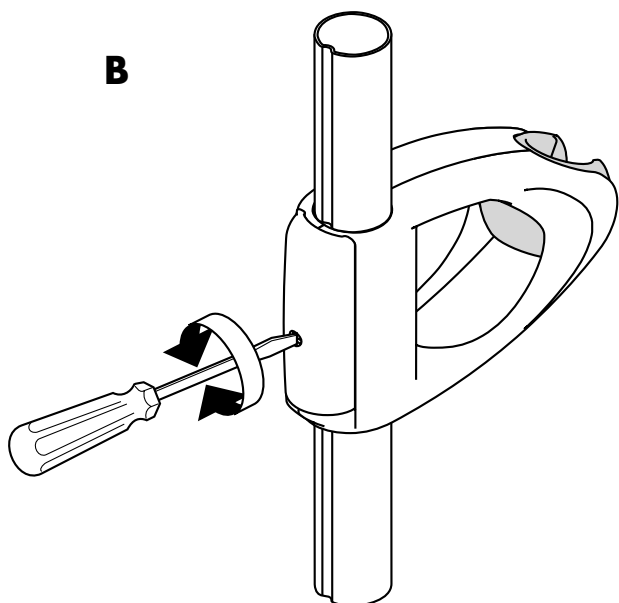

**B**



Deutsch	English	Italiano
<p><b>Thermostat einstellen:</b></p> <ul style="list-style-type: none"> <li>• Umstellgriff (1) aufstecken, Schraube festdrehen (Inbus SW 4).</li> <li>• Umstellgriff in Stellung "Handbrause" (2) stellen und öffnen.</li> <li>• Thermostat auf 38 °C (3) justieren.</li> <li>• Befestigungsschraube (5) Thermostatgriff lösen.</li> <li>• Thermostatgriff abnehmen.</li> <li>• Thermostatgriff senkrecht ausrichten und aufstecken (roter Knopf (4) zeigt nach oben).</li> <li>• Thermostatgriff festschrauben (5).</li> </ul> <p><b>Hinweis:</b> </p> <p>Bei Frostgefahr und Entleerung der Rohrleitung: Regeleinheit ausbauen, Umstellgriff öffnen und die Installationseinheit durch Ausblasen mit Pressluft trocknen (wasserfrei).</p>	<p><b>Adjusting the thermostat:</b></p> <ul style="list-style-type: none"> <li>• Plug on the selection knob (1) and tighten the screw (SW 4 socket wrench).</li> <li>• Set the selection knob to the "Handbrause" (hand shower) position (2) and open it.</li> <li>• Adjust the thermostat to 38 °C (3).</li> <li>• Loosen the fixation screw (5) at the thermostat's knob.</li> <li>• Remove the thermostat knob.</li> <li>• Vertically position the thermostat knob and plug it on (red button (4) points upwards).</li> <li>• Tighten the thermostat knob (5).</li> </ul> <p><b>Note:</b> </p> <p>In cases of frost danger and for pipeline drain: Uninstall the regulation unit, open the selection knob and dry the installation unit by blowing compressed air through it (waterless).</p>	<p><b>Regolazione del termostato:</b></p> <ul style="list-style-type: none"> <li>• Applicare l'impugnatura (1) e serrare a fondo la vite (brugola da 4).</li> <li>• Posizionare l'impugnatura su "Doccia manuale" (2) ed aprirla.</li> <li>• Regolare il termostato su 38 °C (3).</li> <li>• Allentare la vite di fissaggio (5) dell'impugnatura del termostato.</li> <li>• Togliere l'impugnatura del termostato.</li> <li>• Posizionare verticalmente l'impugnatura del termostato ed applicarla (pulsante rosso (4) verso l'alto).</li> <li>• Avvitare l'impugnatura del termostato (5).</li> </ul> <p><b>Avvertenza:</b> </p> <p>In caso di pericolo di congelamento ed evacuazione della tubazione: smontare il regolatore, aprire l'impugnatura ed asciugare il gruppo di installazione con aria compressa (priva di acqua).</p>

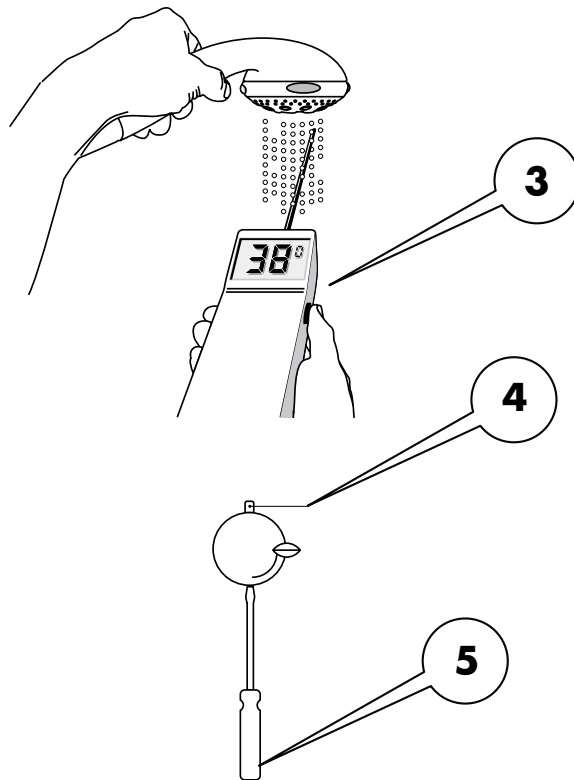
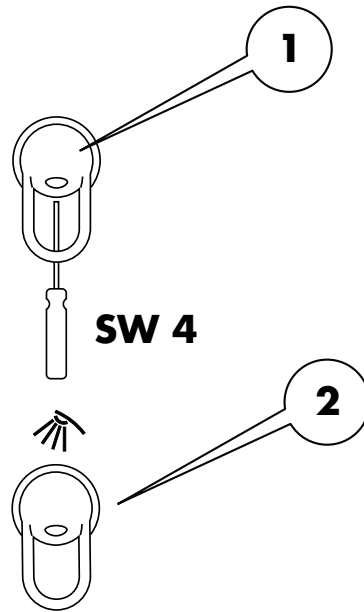
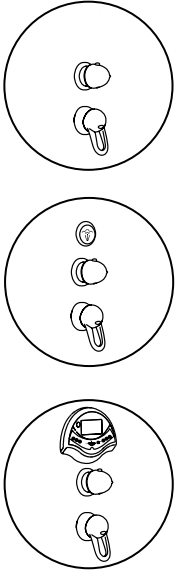

<b>Deutsch</b>	<b>English</b>	<b>Italiano</b>
<p><b>Handbrause Mistral 3:</b></p> <ol style="list-style-type: none"><li>1. Softstrahl</li><li>2. Normalstrahl</li><li>3. Massagestrahl</li></ol> <p><b>Kopfbrause Raindance:</b></p> <ol style="list-style-type: none"><li>1. Rainstrahl</li><li>2. Mix 1</li><li>3. Balance</li><li>4. Mix 2</li><li>5. Whirlstrahl</li></ol>	<p><b>Mistral 3 hand shower:</b></p> <ol style="list-style-type: none"><li>1. Soft jet</li><li>2. Normal jet</li><li>3. Massaging jet</li></ol> <p><b>Raindance head shower:</b></p> <ol style="list-style-type: none"><li>1. Rain jet</li><li>2. Mix 1</li><li>3. Balance</li><li>4. Mix 2</li><li>5. Whirl jet</li></ol>	<p><b>Doccia manuale Mistral 3:</b></p> <ol style="list-style-type: none"><li>1. Getto delicato</li><li>2. Getto normale</li><li>3. Getto di massaggio</li></ol> <p><b>Soffione doccia Raindance:</b></p> <ol style="list-style-type: none"><li>1. Getto a pioggia</li><li>2. Mix 1</li><li>3. Bilanciamento</li><li>4. Mix 2</li><li>5. Getto massaggio</li></ol>

**A**

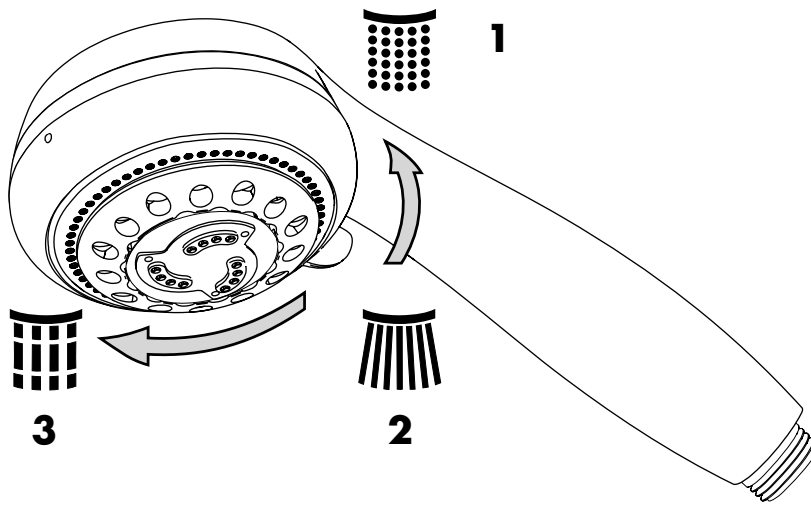



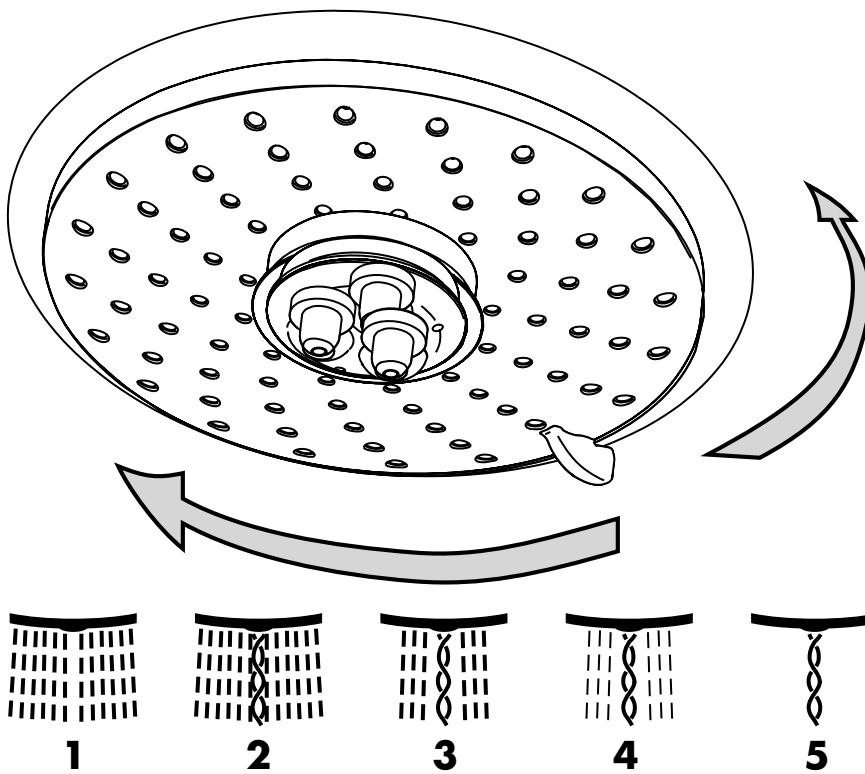



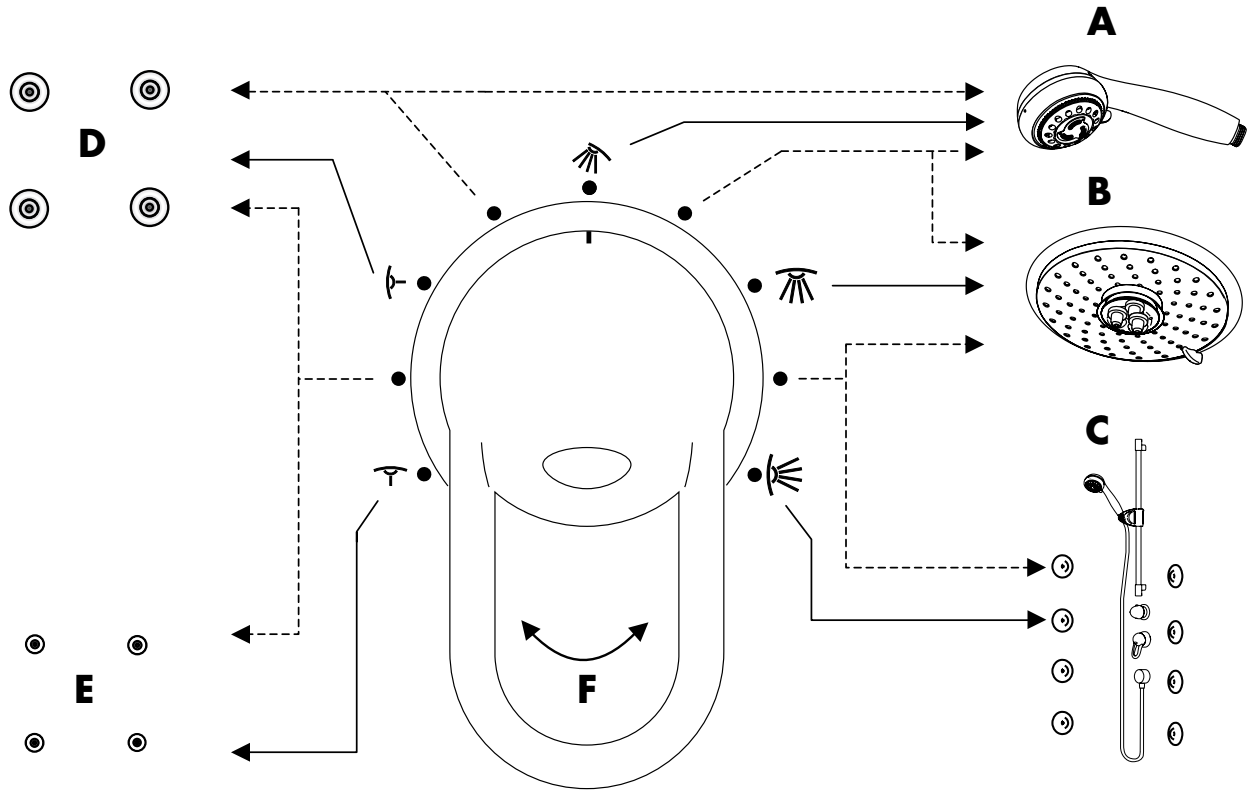



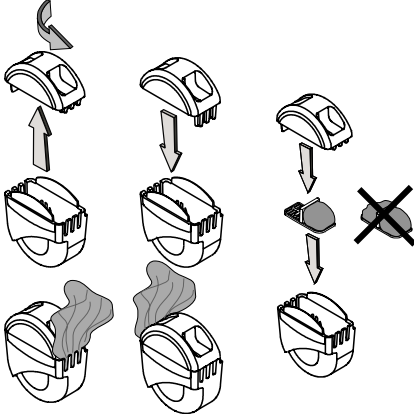

**B**

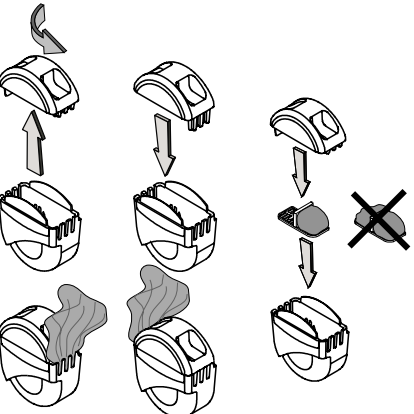

Deutsch	English	Italiano
<p><b>Kombination der Brausen:</b> Die Variothermschaltung ermöglicht es, die Brausen zu aktivieren und zu kombinieren:</p> <p><b>Einzelschaltung:</b> Durchgezogene Linie (siehe Abbildung)</p> <p><b>Kombinationsschaltung:</b> Gestrichelte Linie (siehe Abbildung)</p> <p><b>D. 4 x Rückenbrausen (Düsen)</b> Einzelschaltung und Kombination mit Handbrause oder Nackenjets.</p> <p><b>A. Handbrause</b> Einzelschaltung und Kombination mit Rückenbrause oder Kopfbrause.</p> <p><b>B. Kopfbrause</b> Einzelschaltung und Kombination mit Handbrause oder 8 x Seitenbrausen.</p> <p><b>C. 8 x Seitenbrausen (Düsen)</b> Einzelschaltung und Kombination mit Kopfbrause.</p> <p><b>E. 4 x Nackenbrausen (-jets)</b> Einzelschaltung und Kombination mit den 4 x Rückenbrausen.</p> <p><b>F. Variotherm</b> Einzelschaltung und Kombination der verschiedenen Brausen.</p>	<p><b>Shower combination:</b> The vario thermal setting circuitry enables the activation and combination of the showers:</p> <p><b>Single operation:</b> Normal line (see Fig.)</p> <p><b>Combined operation:</b> Dashed line (see Fig.)</p> <p><b>D. 4 x back showers (nozzles)</b> Single operation and combination with hand shower or neck jets.</p> <p><b>A. Hand shower</b> Single operation and combination with back shower or head shower.</p> <p><b>B. Head shower</b> Single operation and combination with hand shower or eight side showers.</p> <p><b>C. 8 x side showers (nozzles)</b> Single operation and combination with head shower.</p> <p><b>E. 4 x neck jets</b> Single operation and combination with four back showers.</p> <p><b>F. Vario thermal operation</b> Single operation and combination of the various showers.</p>	<p><b>Combinazione delle docce:</b> Il sistema Variotherm consente di attivare e di combinare le docce:</p> <p><b>Comando singolo:</b> Linea continua (vedi figura)</p> <p><b>Comando combinato:</b> Linea tratteggiata (vedi figura)</p> <p><b>D. 4 docce posteriori (ugelli)</b> Comando singolo e combinato con doccia manuale o getti sulla nuca.</p> <p><b>A. Doccia manuale</b> Comando singolo e combinato con doccia posteriore o soffione doccia.</p> <p><b>B. Soffione doccia</b> Comando singolo e combinato con doccia manuale o 8 docce laterali.</p> <p><b>C. 8 docce laterali (ugelli)</b> Comando singolo e combinato con soffione doccia.</p> <p><b>E. 4 docce (getti) sulla nuca</b> Comando singolo e combinato con le 4 docce posteriori.</p> <p><b>F. Variotherm</b> Comando singolo e combinato con le diverse docce.</p>



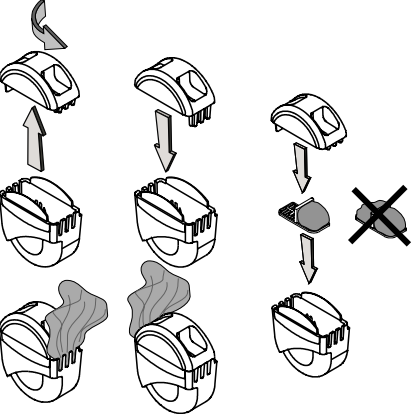



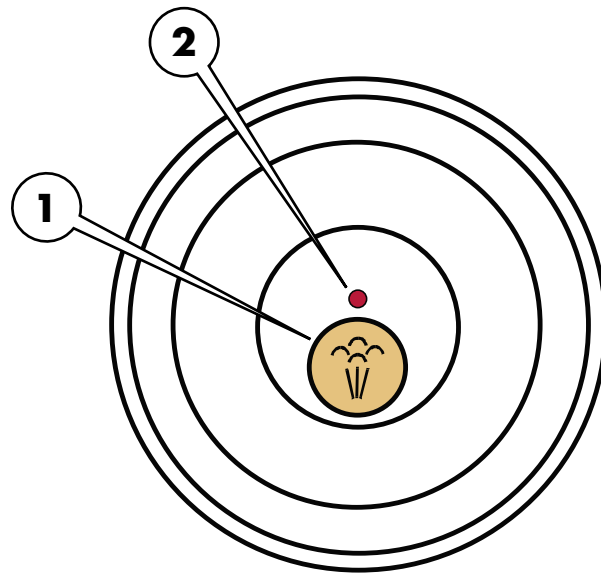
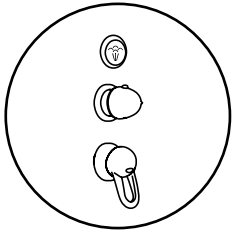





















**Bedienelement (Steam)**  
**Operating Element (Steam)**  
**Funzionamento (bagno di vapore)**

Deutsch	English	Italiano
<p> <b>Dampfbad</b></p> <p>Diese Funktion ermöglicht es ein Dampfbad zu nehmen.</p> <p><b>Warnung!</b> </p> <p><b>Gefahr der Verbrühung</b>  <b>Vor dem Einschalten der Dampffunktion muss der Deckel der Düse so positioniert werden, dass der Dampf in die dem Benutzer entgegengesetzte Richtung entweicht.!</b></p> <p>In den Siebeinsatz des Aromadispenser kann fester Duftstoff eingefüllt werden, z. B. getrocknete Blätter oder auch ein mit Duftstoff getränkter Wattebausch.</p>  <p><b>Dampfbad einschalten (aktivieren)</b></p> <ol style="list-style-type: none"> <li>1. Türe schließen, damit kein Dampf entweichen kann.</li> <li>2. Dampftaste (1) aktivieren, die Leuchtdiode (2) über der Taste leuchtet. Nach ca. 3 Minuten tritt Dampf aus der Düse.</li> </ol> <p><b>Hinweis:</b> </p> <p>Höchstdauer: ca. 50 Minuten          Nach Ablauf der Zeit wird der Dampfaustritt unterbrochen, und das System kehrt in seine Ruhelage zurück.</p> <p>Zum vorzeitigen Beenden des Betriebs kann die Dampftaste (1) erneut betätigt werden.</p> <p><b>Hinweis:</b> </p> <p>Nach dem automatischen oder manuellen Beenden der Dampffunktion wird der Dampfgenerator durch Entleeren und Befüllen abgekühlt. Dies wird durch die blinkende Leuchtdiode (2) über der Dampftaste angezeigt.</p>	<p> <b>Steam bath</b></p> <p>This function enables shower baths.</p> <p><b>Warning!</b> </p> <p><b>Danger of scald</b>  <b>Before activating the steam function, position the head cover so that the steam will go in the direction opposite the user.</b></p> <p>Solid fragrances can be filled into sieve insert of the aroma dispenser, e.g. dried leaves or also cotton wool soaked in essential oils.</p>  <p><b>Switching on the steam bath (activation)</b></p> <ol style="list-style-type: none"> <li>1. Close the door.</li> <li>2. Activate the steam switch (1), the light emitting diode (2) shines. The steam is output approx. 3 minutes after activation.</li> </ol> <p><b>Note:</b> </p> <p>Max. duration: aprox. 50 minutes          After the set duration has expired, the steam output is interrupted and the system returns to its idle position.</p> <p>To stop the operation prematurely terminated, the steam switch (1) has to be switched once more again.</p> <p><b>Note:</b> </p> <p>After the operating time has expired or been prematurely terminated, the steam generator will be cooled off by drain and filling it with water. During this time, the light emitting diode (2) will be blinking.</p>	<p> <b>Bagno a vapore</b></p> <p>Questa funzione consente di fare il bagno di vapore.</p> <p><b>Avvertimento!</b> </p> <p><b>Pericolo di ustioni</b>  <b>Prima di attivare la funzione posizionare il coperchio del diffusore in modo che il vapore vada in direzione opposta all'utente.</b></p> <p>Nell'insero filtro dell'Aromadispenser è possibile inserire anche essenza aromatica di tipo solido come, p. es. foglie secche oppure anche un tampone di ovatta impregnato di essenza aromatica.</p>  <p><b>Attivazione del bagno di vapore</b></p> <ol style="list-style-type: none"> <li>1. Chiudere la porta in modo che il vapore non esca all'esterno.</li> <li>2. Premere il pulsante di avvio (1) per l'attivazione. Il led (2) si accende. Dopo circa 3 dall'attivazione inizia a fuoriuscire vapore.</li> </ol> <p><b>Avvertenza:</b> </p> <p>Durata massima: circa. 50 minuti.          Al termine del tempo, la fuoriuscita di vapore si interrompe ed il sistema ritorna nello stato di riposo.</p> <p>Per interrompere la funzione premere nuovamente il pulsante d'avvio (1).</p> <p><b>Avvertenza:</b> </p> <p>A funzione terminata il generatore di vapore si raffredda attraverso lo scarico ed il riempimento d'acqua. Durante tutta questa fase il led lampeggia (2).</p>



**Elektronisches Bedienelement (Comfort)**  
**Electronic Operating Element (Comfort)**  
**Elemento di comando elettronico (Comfort)**

Deutsch	English	Italiano
<p><b>A. Grundfunktionen:</b></p> <ol style="list-style-type: none"> <li>1. Display</li> <li>2. Reduziertaste</li> <li>3. Steigerungstaste</li> <li>4. ON-/OFF-Taste</li> <li>5. Pfeil-Taste rechts (Cursor nach rechts)</li> <li>6. Pfeil-Taste links (Cursor nach links)</li> <li>7. Programmierungstaste</li> <li>8. Alarntaste</li> </ol> <p><b>B. Alle hier beschriebenen Symbole sind auf dem Display sichtbar:</b></p> <p><input type="checkbox"/> <b>Cursor-Anzeige</b>          (blinkt bei Auswahl und leuchtet im Betriebszustand/aktivem Programm!)</p> <p> <b>OFF</b> (Display ausgeschaltet)</p> <p> <b>ON</b> (Display eingeschaltet)</p> <p>&lt; "Pfeil"-Taste nach links</p> <p>&gt; "Pfeil"-Taste nach rechts</p> <p><b>Funktionen:</b></p> <p> <b>Tastensperre</b> (Kindersicherung)</p> <p> <b>Alarm-Taste</b></p> <p> <b>"Back Rain" (8 x Seitenbrausen)</b>          (Intervallschaltung möglich)</p> <p> <b>4 x Rückenbrausen</b>          (Intervallschaltung möglich)</p> <p> <b>"Nackenjet" (4 x Nackendüsen)</b>          (Intervallschaltung möglich)</p> <p> <b>Dampfbad</b></p> <p> <b>Weißlicht</b></p>	<p><b>A. Basic functions:</b></p> <ol style="list-style-type: none"> <li>1. Display</li> <li>2. Reduction key</li> <li>3. Progression key</li> <li>4. ON/OFF key</li> <li>5. Right arrow key (cursor to the right)</li> <li>6. Left arrow key (cursor to the left)</li> <li>7. Programming key</li> <li>8. Alarm key</li> </ol> <p><b>B. All symbols described here are visible on the display:</b></p> <p><input type="checkbox"/> <b>Cursor indication</b>          (flashes during selection and is illuminated when in operating mode/active program!)</p> <p> <b>OFF</b> (display switched off)</p> <p> <b>ON</b> (display switched on)</p> <p>&lt; "Arrow" key to the left</p> <p>&gt; "Arrow" key to the right</p> <p><b>Functions:</b></p> <p> <b>Key lock</b> (child lock)</p> <p> <b>Alarm key</b></p> <p> <b>"Back rain" (8 x side showers)</b>          (interval operation option)</p> <p> <b>4 x back showers</b>          (interval operation option)</p> <p> <b>"Neck jet" (4 x neck nozzles)</b>          (interval operation option)</p> <p> <b>Steam bath</b></p> <p> <b>light</b></p>	<p><b>A. Funzioni di base:</b></p> <ol style="list-style-type: none"> <li>1. Display</li> <li>2. Tasto di riduzione</li> <li>3. Tasto di aumento</li> <li>4. Tasto ON/OFF</li> <li>5. Tasto a freccia verso destra (cursore verso destra)</li> <li>6. Tasto a freccia verso sinistra (cursore verso sinistra)</li> <li>7. Tasto di programmazione</li> <li>8. Tasto di allarme</li> </ol> <p><b>B. Tutti i simboli qui descritti sono visibili sul display:</b></p> <p><input type="checkbox"/> <b>Cursor</b>          (lampeggia durante la selezione ed è acceso durante il funzionamento / programma attivo!)</p> <p> <b>OFF</b> (display spento)</p> <p> <b>ON</b> (display acceso)</p> <p>&lt; Tasto a freccia verso sinistra</p> <p>&gt; Tasto a freccia verso destra</p> <p><b>Funzioni:</b></p> <p> <b>Blocco tastiera</b> (sicura bambini)</p> <p> <b>Tasto di allarme</b></p> <p> <b>"Pioggia" (8 docce laterali)</b>          (intermittenza possibile)</p> <p> <b>4 docce posteriori</b>          (intermittenza possibile)</p> <p> <b>"Getto sulla nuca" (4 ugelli della nuca)</b>          (intermittenza possibile)</p> <p> <b>Bagno a vapore</b></p> <p> <b>luce bianca</b></p>

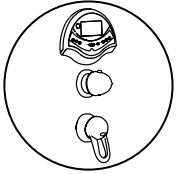



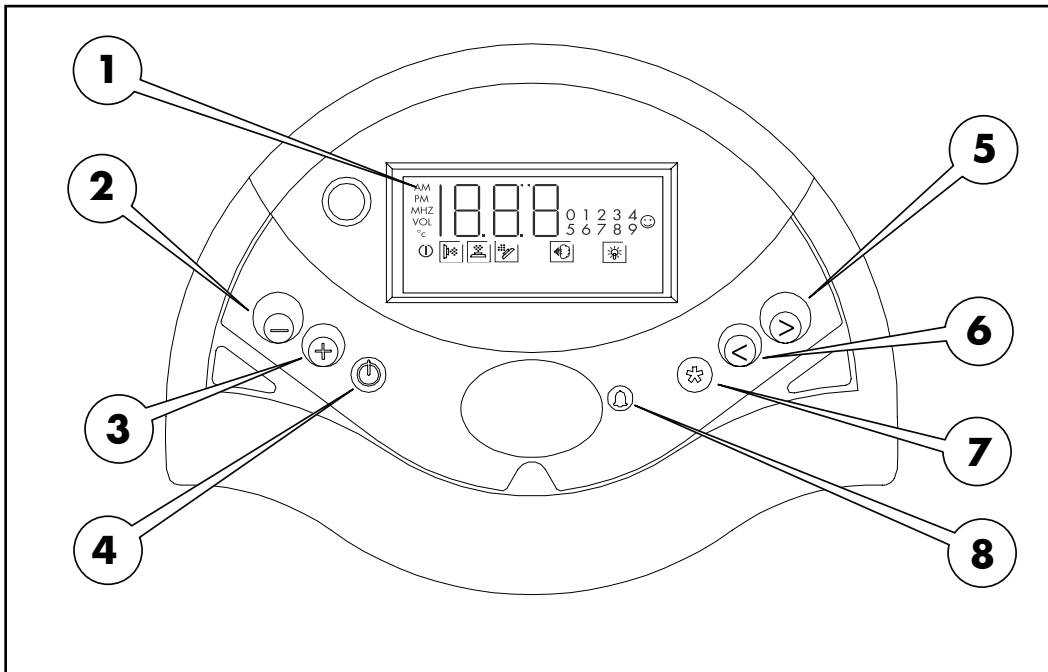



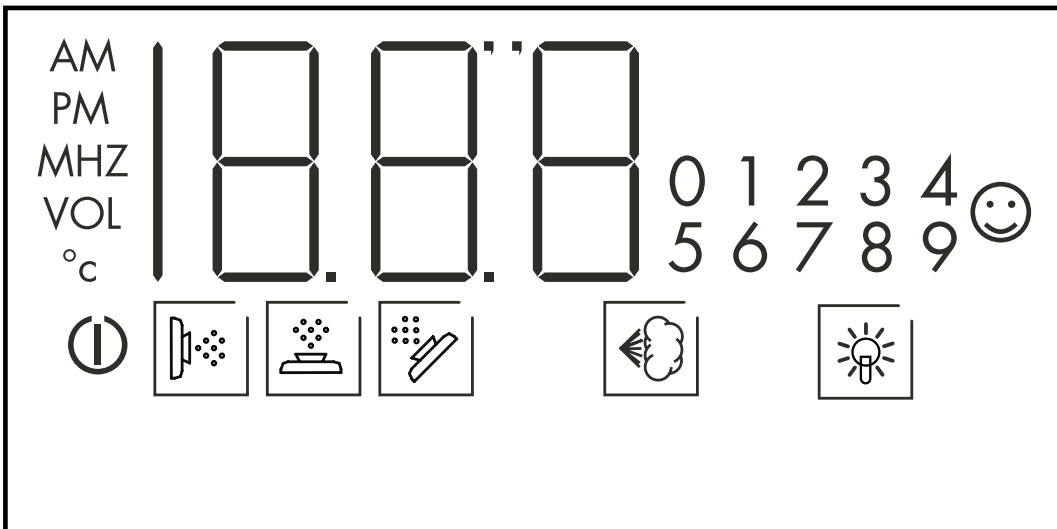

























**A**



**B**



**Elektronisches Bedienelement (Deluxe)**  
**Electronic Operating Element (Deluxe)**  
**Elemento di comando elettronico (Deluxe)**

Deutsch	English	Italiano
<p><b>A. Grundfunktionen:</b></p> <ol style="list-style-type: none"> <li>1. Display</li> <li>2. Reduziertaste</li> <li>3. Steigerungstaste</li> <li>4. ON-/OFF-Taste</li> <li>5. Pfeil-Taste rechts (Cursor nach rechts)</li> <li>6. Pfeil-Taste links (Cursor nach links)</li> <li>7. Programmierungstaste</li> <li>8. Alarmtaste</li> </ol> <p><b>B. Alle hier beschriebenen Symbole sind auf dem Display sichtbar:</b></p> <p><input type="checkbox"/> <b>Cursor-Anzeige</b>          (blinkt bei Auswahl und leuchtet im Betriebszustand/aktivem Programm!)</p> <p> <b>OFF</b> (Display ausgeschaltet)</p> <p> <b>ON</b> (Display eingeschaltet)</p> <p>&lt; "Pfeil"-Taste nach links</p> <p>&gt; "Pfeil"-Taste nach rechts</p> <p><b>Funktionen:</b></p> <p> <b>Tastensperre</b> (Kindersicherung)</p> <p> <b>Alarm-Taste</b></p> <p> <b>"Back Rain" (8 x Seitenbrausen)</b>          (Intervallschaltung möglich)</p> <p> <b>4 x Rückenbrausen</b>          (Intervallschaltung möglich)</p> <p> <b>"Nackenjet" (4 x Nackendüsen)</b>          (Intervallschaltung möglich)</p> <p> <b>"Schottische Dusche"</b>          (Kaltwasserbeimischung)</p> <p> <b>Dampfbad</b></p> <p> <b>"Radio"</b></p> <p> <b>Chromotherapie</b></p>	<p><b>A. Basic functions:</b></p> <ol style="list-style-type: none"> <li>1. Display</li> <li>2. Reduction key</li> <li>3. Progression key</li> <li>4. ON/OFF key</li> <li>5. Right arrow key (cursor to the right)</li> <li>6. Left arrow key (cursor to the left)</li> <li>7. Programming key</li> <li>8. Alarm key</li> </ol> <p><b>B. All symbols described here are visible on the display:</b></p> <p><input type="checkbox"/> <b>Cursor indication</b>          (flashes during selection and is illuminated when in operating mode/active program!)</p> <p> <b>OFF</b> (display switched off)</p> <p> <b>ON</b> (display switched on)</p> <p>&lt; "Arrow" key to the left</p> <p>&gt; "Arrow" key to the right</p> <p><b>Functions:</b></p> <p> <b>Key lock</b> (child lock)</p> <p> <b>Alarm key</b></p> <p> <b>"Back rain" (8 x side showers)</b>          (interval operation option)</p> <p> <b>4 x back showers</b>          (interval operation option)</p> <p> <b>"Neck jet" (4 x neck nozzles)</b>          (interval operation option)</p> <p> <b>"Scotch shower"</b>          (cold water addition)</p> <p> <b>Steam bath</b></p> <p> <b>"Radio"</b></p> <p> <b>Chromo therapy</b></p>	<p><b>A. Funzioni di base:</b></p> <ol style="list-style-type: none"> <li>1. Display</li> <li>2. Tasto di riduzione</li> <li>3. Tasto di aumento</li> <li>4. Tasto ON/OFF</li> <li>5. Tasto a freccia verso destra (cursore verso destra)</li> <li>6. Tasto a freccia verso sinistra (cursore verso sinistra)</li> <li>7. Tasto di programmazione</li> <li>8. Tasto di allarme</li> </ol> <p><b>B. Tutti i simboli qui descritti sono visibili sul display:</b></p> <p><input type="checkbox"/> <b>Cursor</b>          (lampeggia durante la selezione ed è acceso durante il funzionamento / programma attivo!)</p> <p> <b>OFF</b> (display spento)</p> <p> <b>ON</b> (display acceso)</p> <p>&lt; Tasto a freccia verso sinistra</p> <p>&gt; Tasto a freccia verso destra</p> <p><b>Funktionen:</b></p> <p> <b>Blocco tastiera</b> (sicura bambini)</p> <p> <b>Tasto di allarme</b></p> <p> <b>"Pioggia" (8 docce laterali)</b>          (intermittenza possibile)</p> <p> <b>4 docce posteriori</b>          (intermittenza possibile)</p> <p> <b>"Getto sulla nuca" (4 ugelli della nuca)</b>          (intermittenza possibile)</p> <p> <b>"Doccia scozzese"</b>          (aggiunta di acqua fredda)</p> <p> <b>Bagno a vapore</b></p> <p> <b>"Radio"</b></p> <p> <b>Cromoterapia</b></p>

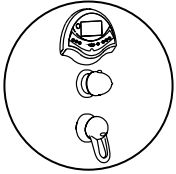



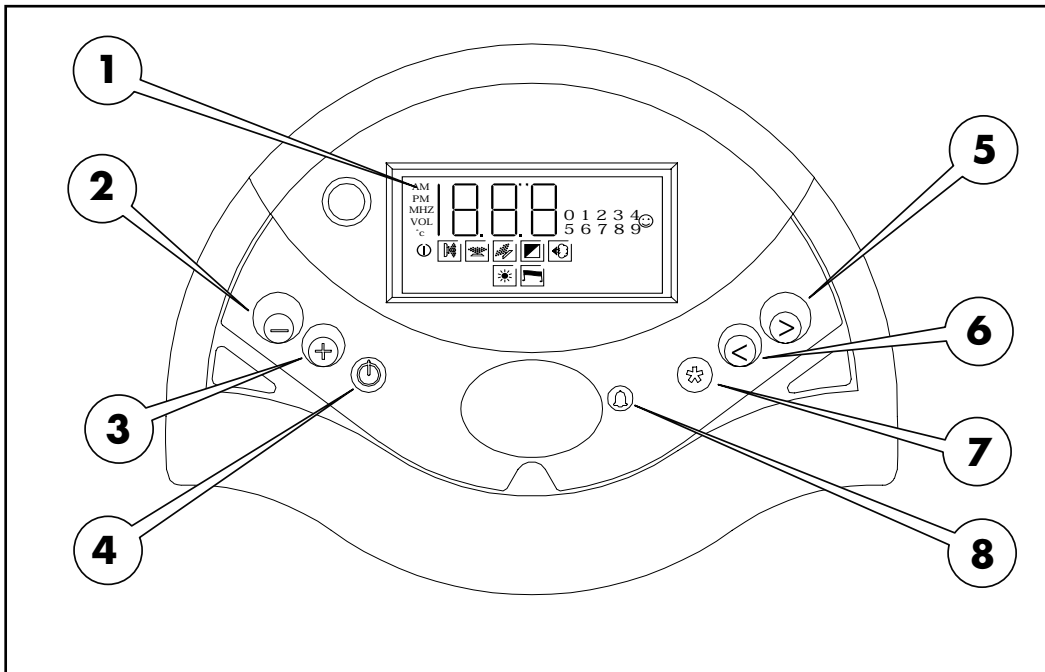



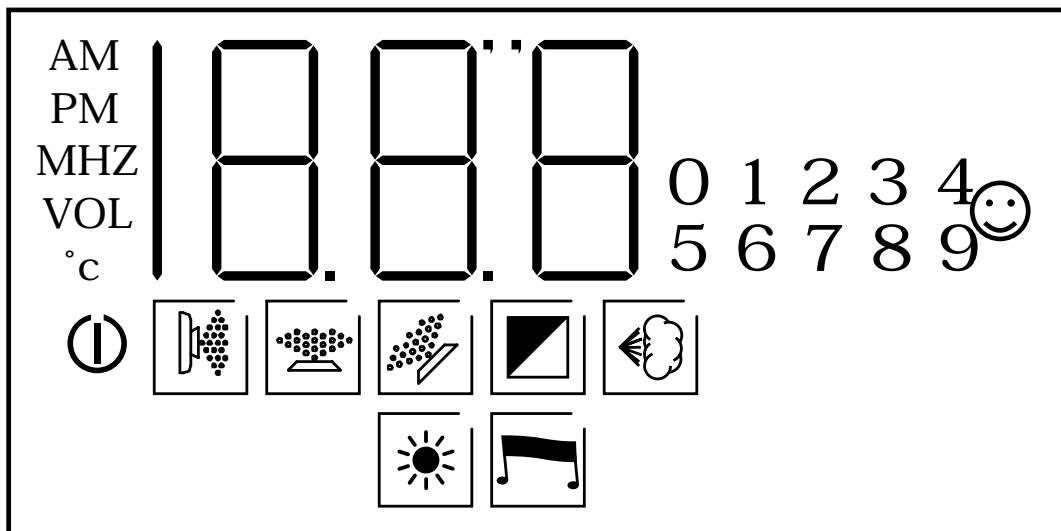











**A**











**B**









Deutsch	English	Italiano
<p> <b>Tastensperre</b> (Kinderschutzanzeige)</p> <p><b>Aktivierung und Deaktivierung durch gleichzeitiges Drücken beider "Pfeil-Tasten"</b> ( &lt; / &gt; )</p> <p> <b>Alarm-Taste</b> (Notausschaltung)</p> <p>Durch Betätigen der <b>"Alarm"</b>-Taste werden sämtliche Betriebs-Funktionen unterbrochen. Ein Alarmsignal ertönt 3 Minuten lang. Die Beleuchtung und das Radio bleiben an.</p> <p><b>Hinweis:</b> </p> <p>Mit der <b>"Alarm"</b>-Taste kann die Alarm Funktion abgebrochen werden!</p> <p> <b>"Back Rain" Funktion</b> (Ganzkörpermassage)</p> <p>Diese Funktion ermöglicht es die 4 Pharo Seitenbrausenpaare (4 x 2; mit Massagestrahl) nacheinander von unten nach oben zu aktivieren.</p> <p><b>Programmfunktion:</b></p> <ul style="list-style-type: none"> <li>• Ein- bzw. Ausschalten einzelner Seitenbrausenpaare</li> <li>• Zeitfunktion: Gesamtdauer der Massage</li> <li>• Zeitfunktion: Wasserabgabe-/Pausenzeit</li> </ul> <p>Grundeinstellung: In der Grundeinstellung werden die Pharo Seitenbrausen von unten nach oben aufeinanderfolgend aktiviert.</p>	<p> <b>Key lock</b> (child lock indication)</p> <p><b>Activation and deactivation by simultaneous depression of both "arrow keys".</b> ( &lt; / &gt; )</p> <p> <b>Alarm key</b> (emergency off-switch)</p> <p>By pressing the <b>"Alarm"</b> key, all operating functions are interrupted. An alarm signal is audible for three minutes. The illumination and the radio remain switched on.</p> <p><b>Note:</b> </p> <p>The alarm function can be interrupted via the <b>"Alarm"</b> key!</p> <p> <b>"Back rain" function</b> (whole-body massage)</p> <p>This function will enable you to subsequently activate 4 Pharo side shower pairs (4 x 2; with massaging jet) from the bottom to the top.</p> <p><b>Program function:</b></p> <ul style="list-style-type: none"> <li>• Switch-on or switch-off of individual side showers</li> <li>• Time function: Total massaging duration</li> <li>• Time function: water output time/break</li> </ul> <p>Basic setting: In the basic setting, the Pharo side showers are subsequently activated from the bottom to the top.</p>	<p> <b>Blocco tastiera</b> (sicura bambini)</p> <p><b>Attivazione e disattivazione premendo contemporaneamente i due tasti a freccia</b> ( &lt; / &gt; )</p> <p> <b>Tasto di allarme</b> (spegnimento di emergenza)</p> <p>Premendo il tasto <b>"Allarme"</b> si interrompono tutte le funzioni del sistema. Per 3 minuti viene emesso un segnale di allarme. L'illuminazione e la radio restano accese.</p> <p><b>Avvertenza:</b> </p> <p>Con il tasto <b>"Allarme"</b> si può disattivare la funzione di allarme!</p> <p> <b>Funzione "Pioggia"</b> (massaggio integrale)</p> <p>Questa funzione consente di attivare le 4 paia di getti laterali Pharo (4 x 2; con getto per massaggio) in successione dal basso verso l'alto.</p> <p><b>Funzione di programma:</b></p> <ul style="list-style-type: none"> <li>• Accensione oppure spegnimento di singole paia di getti laterali</li> <li>• Funzione durata: durata complessiva del massaggio</li> <li>• Funzione durata: durata del getto d'acqua e durata della pausa</li> </ul> <p>Impostazione di base: Nell'impostazione di base le docce laterali Pharo si attivano in successione dal basso verso l'alto.</p>



Deutsch	English	Italiano
<p><b>Seitenbrausen ein- oder ausschalten:</b></p> <ol style="list-style-type: none"> <li>1. Mit der Pfeil-Taste (links oder rechts) den Cursor auf dem <b>"Back Rain"</b>-Symbol positionieren. Mit der Stern-Taste bestätigen</li> <li>2. Auf dem Display erscheint die Meldung <b>"ON"</b> (aktiv) und die Zahl <b>"1"</b> die zu blinken beginnt. Die <b>"1"</b> steht für das unterste Seitenbrausenpaar. Die Nummerierung verläuft von unten nach oben.</li> <li>3. Seitenbrausenpaare (1,2,3,4) mit Pfeil-Taste links oder rechts auswählen und mit der Minus-Taste deaktivieren oder mit der Plus-Taste aktivieren. Auswahl mit der Stern-Taste bestätigen.</li> </ol> <p><b>Hinweis:</b> </p> <p>Die Einstellungen werden im System bis zur nächsten Programmierung abgelegt! Bei Unterbrechung der Stromversorgung werden die Einstellungen gelöscht!</p> <ol style="list-style-type: none"> <li>4. Den Cursor mit den Pfeiltasten auf das <b>"Back Rain"</b>-Symbol positionieren.</li> <li>5. Mit der <b>"ON/OFF"</b>-Taste die Einstellung aktivieren.</li> </ol> <p><b>Dauer der Massage:</b></p> <p>Die Zeit (zum Beispiel 20 Minuten) mit der Plus-Taste oder Minus-Taste einstellen. Wird die Plus- oder Minus-Taste gedrückt gehalten, wird die Zu- bzw. Abnahme der Minutenangabe gefolgt von einem <b>"d"</b> angezeigt. Auswahl mit Stern-Taste bestätigen.</p> <p><b>Hinweis:</b> </p> <p>Minstdauer: 5 Minuten Höchstdauer: 60 Minuten</p> <p><b>Betrieb:</b></p> <p>Während des Betriebs können die Einstellungen geändert werden.</p> <ol style="list-style-type: none"> <li>1. Funktionsdauer (<b>"Back Rain"</b>): Stern-Taste drücken. Änderung durch Drücken der Plus- oder Minus-Taste. Auswahl mit der Stern-Taste bestätigen.</li> </ol>	<p><b>Switching the side showers on or off:</b></p> <ol style="list-style-type: none"> <li>1. Position the cursor on the <b>"Back rain"</b> symbol via the arrow key (left or right). Confirm your selection with the star key.</li> <li>2. The display shows the message <b>"ON"</b> (active) and a flashing figure <b>"1"</b>. The <b>"1"</b> stands for the lower side shower pair. The numbering's sequence is from the bottom to the top.</li> <li>3. Select the side shower pairs (1,2,3,4) via the left or right arrow key and deactivate them via the minus key or activate them via the plus key. Confirm your selection with the star key.</li> </ol> <p><b>Note:</b> </p> <p>The settings are stored in the system until the next programming! If the power supply is interrupted, the settings are deleted!</p> <ol style="list-style-type: none"> <li>4. Position the cursor on the <b>"Back rain"</b> symbol via the arrow keys.</li> <li>5. Activate the setting via the <b>"ON/OFF"</b> key.</li> </ol> <p><b>Massaging duration:</b></p> <p>Set the time (e.g. 20 minutes) via the plus or the minus key. If the plus or the minus key is held depressed, the increase or decrease of the minute setting, followed by a <b>"d"</b>, is shown. Confirm your selection with the star key.</p> <p><b>Note:</b> </p> <p>Min. duration: 5 minutes Max. duration: 60 minutes</p> <p><b>Operation:</b></p> <p>The settings can be changed during operation.</p> <ol style="list-style-type: none"> <li>1. Function duration (<b>"Back rain"</b>): Press the star key. Press the plus or minus key for changes. Confirm your selection with the star key.</li> </ol>	<p><b>Attivazione e disattivazione delle docce laterali:</b></p> <ol style="list-style-type: none"> <li>1. Con il tasto a freccia (verso sinistra o verso destra) portare il cursore sul simbolo <b>"Pioggia"</b>. Confermare con il tasto dell'asterisco.</li> <li>2. Sul display compare il messaggio <b>"ON"</b> (attivo) ed il numero <b>"1"</b> che inizia a lampeggiare. Il numero <b>"1"</b> rappresenta il paio di getti laterali più in basso. La numerazione va dal basso verso l'alto.</li> <li>3. Selezionare le paia di getti laterali (1,2,3,4) con il tasto a freccia verso sinistra o verso destra e disattivarle con il tasto "-" o attivarle con il tasto "+". Confermare la selezione con il tasto dell'asterisco.</li> </ol> <p><b>Avvertenza:</b> </p> <p>Le impostazioni vengono salvate nel sistema fino alla programmazione successiva! In caso di black-out le impostazioni vanno perdute!</p> <ol style="list-style-type: none"> <li>4. Con i tasti a freccia portare il cursore sul simbolo <b>"Pioggia"</b>.</li> <li>5. Attivare l'impostazione con il tasto <b>"ON/OFF"</b>.</li> </ol> <p><b>Durata del massaggio:</b></p> <p>Impostare il tempo (ad esempio 20 minuti) con il tasto "+" o "-". Tenendo premuto il tasto "+" o "-", l'aumento o la diminuzione dei minuti viene visualizzato seguito da una <b>"d"</b>. Confermare la selezione con il tasto dell'asterisco.</p> <p><b>Avvertenza:</b> </p> <p>Durata minima: 5 minuti. Durata massima: 60 minuti.</p> <p><b>Funzionamento:</b></p> <p>Durante il funzionamento si possono modificare le impostazioni.</p> <ol style="list-style-type: none"> <li>1. Durata del funzionamento (<b>"Pioggia"</b>): premere il tasto dell'asterisco. modifica con il tasto "+" o "-". Confermare la selezione con il tasto dell'asterisco.</li> </ol>







**Elektronisches Bedienelement (Comfort/ Deluxe)**  
**Electronic Operating Element (Comfort/ Deluxe)**  
**Elemento di comando elettronico (Comfort/ Deluxe)**

Deutsch	English	Italiano
<p>Nach der Bestätigung erscheint der Buchstabe <b>"A"</b> gefolgt von der Öffnungszeit (Wasserabgabe) der Seitenbrausen in Sekunden.</p> <p><b>2.</b> Öffnungszeit (in Sekunden) Seitenbrausen durch Plus- oder Minus-Taste einstellen.</p> <p><b>Hinweis:</b> </p> <p>Mindestdauer: 1 Sekunde          Höchstdauer: 9,5 Sekunden</p> <p><b>3.</b> Die Öffnungszeit der Wasserabgabe mit der Stern-Taste bestätigen.</p> <p>Nach der Bestätigung erscheint der Buchstabe <b>"S"</b> gefolgt von der Pausenzeit (keine Wasserabgabe).</p> <p><b>4.</b> Mit der Plus- oder Minus-Taste die Pausen einstellen.</p> <p><b>Hinweis:</b> </p> <p>Mindestdauer: 0 Sekunden          Höchstdauer: 9,5 Sekunden</p> <p><b>5.</b> Die Pausenzeit mit der Stern-Taste bestätigen.</p> <p>Zum Beenden des Betriebs den Cursor mit der Pfeil-Taste auf das <b>"Back Rain"</b>-Symbol positionieren, dann <b>"ON-/OFF"</b>-Taste drücken. Nach Ablauf der Betriebszeit oder dem vorzeitigen Beenden des Betriebs ertönt ein Signalton (2 Sek.).</p> <p> <b>Rückenbrausen</b>          (Rückenmassage)</p> <p>Diese Funktion ermöglicht es, die 4 x Pharo Rückenbrausen (mit Massagestrahl) eine bestimmte Zeit zu öffnen (aktivieren).</p> <p><b>Programmfunktion:</b></p> <ul style="list-style-type: none"> <li>• Zeitfunktion: Dauer der Massage</li> </ul>	<p>After the confirmation, the letter <b>"A"</b>, followed by the side showers' opening duration (water output) in seconds, is shown.</p> <p><b>2.</b> Set the side showers' opening duration (in seconds) via the plus or minus key.</p> <p><b>Note:</b> </p> <p>Min. duration: 1 second          Max. duration: 9.5 seconds</p> <p><b>3.</b> Confirm the water output's duration with the star key.</p> <p>After the confirmation, the letter <b>"S"</b>, followed by the break time (no water output), is shown.</p> <p><b>4.</b> Set the breaks via the plus or minus key.</p> <p><b>Note:</b> </p> <p>Min. duration: 0 seconds          Max. duration: 9.5 seconds</p> <p><b>5.</b> Confirm the break duration with the star key.</p> <p>To stop the operation, position the cursor on the <b>"Back rain"</b> symbol via the arrow key and press the <b>"ON/OFF"</b> key. After the operating time has expired or been prematurely terminated, a signal tone is output (2 sec.).</p> <p> <b>back showers</b>          (back massage)</p> <p>This function enables the opening of the 4 x Pharo back showers (with massaging jet) for a specified duration (activation).</p> <p><b>Program function:</b></p> <ul style="list-style-type: none"> <li>• Time function: Massaging duration</li> </ul>	<p>Dopo la conferma compare la lettera <b>"A"</b> seguita dal tempo di apertura (mandata d'acqua) delle docce laterali.</p> <p><b>2.</b> Regolare il tempo di apertura (in secondi) delle docce laterali con il tasto "+" o "-".</p> <p><b>Avvertenza:</b> </p> <p>Durata minima: 1 secondo.          Durata massima: 9,5 secondi.</p> <p><b>3.</b> Confermare il tempo di apertura con il tasto dell'asterisco.</p> <p>Dopo la conferma compare la lettera <b>"S"</b> seguita dal tempo di pausa (interruzione della mandata d'acqua).</p> <p><b>4.</b> Impostare le pause con il tasto "+" o "-".</p> <p><b>Avvertenza:</b> </p> <p>Durata minima: 0 secondi.          Durata massima: 9,5 secondi.</p> <p><b>5.</b> Confermare il tempo di pausa con il tasto dell'asterisco.</p> <p>Per disattivare il funzionamento, con i tasti a freccia portare il cursore sul simbolo <b>"Pioggia"</b> e quindi premere il tasto <b>"ON/OFF"</b>. Al termine del tempo di funzionamento o se il funzionamento viene disattivato prima del tempo programmato viene emesso un segnale acustico (2 secondi).</p> <p> <b>docce posteriori</b>          (massaggio della schiena)</p> <p>Questa funzione consente di aprire (attivare) le 4 docce posteriori Pharo (con getto per massaggio) per un determinato tempo.</p> <p><b>Funzione di programma:</b></p> <ul style="list-style-type: none"> <li>• Funzione temporale: durata del massaggio</li> </ul>



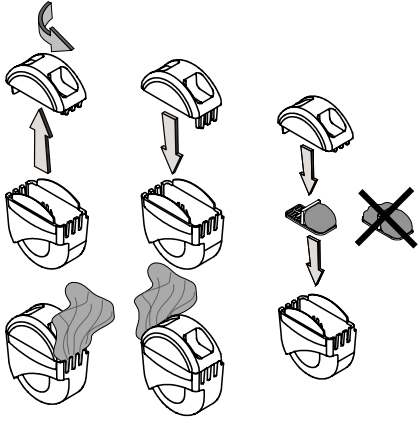

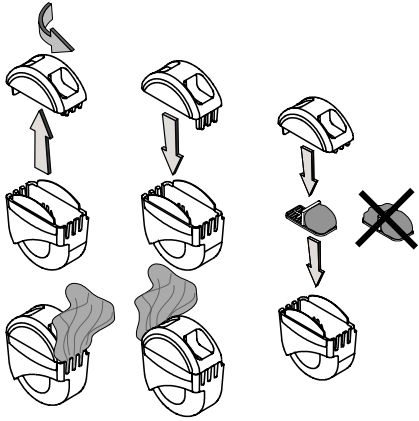

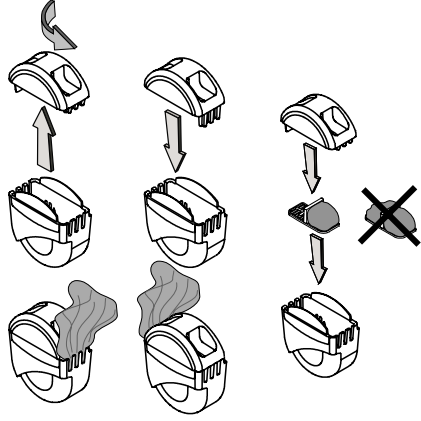







Deutsch	English	Italiano
<p><b>Dauer der Massage:</b></p> <p><b>1.</b> Mit der Pfeil-Taste (links oder rechts) den Cursor auf dem <b>"Rückenbrausen"</b>-Symbol plazieren. Auswahl mit der Stern-Taste bestätigen.</p> <p><b>2.</b> Die Zeit (Voreinstellung zum Beispiel 20 Minuten) mit der Plus-Taste oder Minus-Taste einstellen. Wird die Plus- oder Minustaste gedrückt gehalten, wird die Zu- bzw. Abnahme der Minutenangabe gefolgt von einem <b>"d"</b> angezeigt. Auswahl mit der Stern-Taste bestätigen.</p> <p><b>Hinweis:</b> </p> <p>Minstdauer: 5 Minuten Höchstdauer: 60 Minuten</p> <p>Die Einstellungen werden im System bis zur nächsten Programmierung abgelegt! Bei Unterbrechung der Stromversorgung werden die Einstellungen gelöscht!</p> <p>Zum Beenden des Betriebs den Cursor mit der Pfeil-Taste auf das <b>"Rückenbrausen"</b>-Symbol positionieren, dann <b>"ON-/OFF"</b>-Taste drücken. Nach Ablauf der Betriebszeit oder dem vorzeitigen Beenden des Betriebs ertönt ein Signalton (2 Sek.).</p> <p> <b>"Nackenjet"-Funktion</b> (Nacken- und Rückenmassage)</p> <p>Diese Funktion ermöglicht es, die 4 Nackenjets eine bestimmte Zeit zu öffnen (aktivieren).</p> <p><b>Programmfunktion:</b></p> <ul style="list-style-type: none"> <li>• Zeitfunktion: Dauer der Massage</li> </ul>	<p><b>Massaging duration:</b></p> <p><b>1.</b> Position the cursor on the <b>"back showers"</b> symbol via the arrow key (left or right). Confirm your selection with the star key.</p> <p><b>2.</b> Set the time (e.g. 20 minutes presetting) via the plus or the minus key. If the plus or minus key is held depressed, the increase or decrease of the minute setting, followed by a <b>"d"</b>, is shown. Confirm your selection with the star key.</p> <p><b>Note:</b> </p> <p>Min. duration: 5 minutes Max. duration: 60 minutes</p> <p>The settings are stored in the system until the next programming! If the power supply is interrupted, the settings are deleted!</p> <p>To stop the operation, position the cursor on the <b>"back showers"</b> symbol via the arrow key and press the <b>"ON/OFF"</b> key. After the operating time has expired or been prematurely terminated, a signal tone is output (2 sec.).</p> <p> <b>"Neck jet" function</b> (neck and back massage)</p> <p>This function enables an opening of the 4 x neck jets for a specified duration (activation).</p> <p><b>Program function:</b></p> <ul style="list-style-type: none"> <li>• Time function: Massaging duration</li> </ul>	<p><b>Durata del massaggio:</b></p> <p><b>1.</b> Con il tasto a freccia (verso sinistra o verso destra) portare il cursore sul simbolo <b>"Docce posteriori"</b>. Confermare la selezione con il tasto dell'asterisco.</p> <p><b>2.</b> Impostare il tempo (preimpostazione ad esempio 20 minuti) con il tasto "+" o "-". Tenendo premuto il tasto "+" o "-", l'aumento o la diminuzione dei minuti viene visualizzato seguito da una <b>"d"</b>. Confermare la selezione con il tasto dell'asterisco.</p> <p><b>Avvertenza:</b> </p> <p>Durata minima: 5 minuti. Durata massima: 60 minuti.</p> <p>Le impostazioni vengono salvate nel sistema fino alla programmazione successiva! In caso di black-out le impostazioni vanno perdute!</p> <p>Per disattivare il funzionamento, con i tasti a freccia portare il cursore sul simbolo <b>"Docce posteriori"</b> e quindi premere il tasto <b>"ON/OFF"</b>. Al termine del tempo di funzionamento o se il funzionamento viene disattivato prima del tempo programmato viene emesso un segnale acustico (2 secondi).</p> <p> <b>Funzione "Getto sulla nuca"</b> (massaggio della nuca e della schiena)</p> <p>Questa funzione consente di aprire (attivare) i 4 getti sulla nuca per un determinato tempo.</p> <p><b>Funzione di programma:</b></p> <ul style="list-style-type: none"> <li>• Funzione temporale: durata del massaggio.</li> </ul>



**Elektronisches Bedienelement (Comfort/ Deluxe)**  
**Electronic Operating Element (Comfort/ Deluxe)**  
**Elemento di comando elettronico (Comfort/ Deluxe)**

Deutsch	English	Italiano
<p><b>Dauer der Massage:</b></p> <ol style="list-style-type: none"> <li>1. Mit der Pfeil-Taste (links oder rechts) den Cursor auf dem <b>"Nackenjet"</b>-Symbol positionieren. Auswahl mit der Stern-Taste bestätigen.</li> <li>2. Die Zeit (Vorgabe 20 Minuten) mit der Plus-Taste oder Minus-Taste einstellen. Wird die Plus- oder Minustaste gedrückt gehalten, wird die Zu- bzw. Abnahme der Minutenangabe gefolgt von einem <b>"d"</b> angezeigt. Auswahl mit der Stern-Taste bestätigen.</li> </ol> <p><b>Hinweis:</b> </p> <p>Mindestdauer: 5 Minuten  Höchstdauer: 60 Minuten</p> <p>Die Einstellungen werden im System bis zur nächsten Programmierung abgelegt!  Bei Unterbrechung der Stromversorgung werden die Einstellungen gelöscht!</p> <p>Zum Beenden des Betriebs den Cursor mit der Pfeil-Taste auf das <b>"Nackenjet"</b>-Symbol positionieren, dann <b>"ON/OFF"</b>-Taste drücken. Nach Ablauf der Betriebszeit oder dem vorzeitigen Beenden des Betriebs ertönt ein Signalton (2 Sek.).</p>	<p><b>Massaging duration:</b></p> <ol style="list-style-type: none"> <li>1. Position the cursor on the <b>"Neck jet"</b> symbol via the arrow key (left or right). Confirm your selection with the star key.</li> <li>2. Set the time (20 minutes presetting) via the plus or the minus key. If the plus or minus key is held depressed, the increase or decrease of the minute setting, followed by a <b>"d"</b>, is shown. Confirm your selection with the star key.</li> </ol> <p><b>Note:</b> </p> <p>Min. duration: 5 minutes  Max. duration: 60 minutes</p> <p>The settings are stored in the system until the next programming!  If the power supply is interrupted, the settings are deleted!</p> <p>To stop the operation, position the cursor on the <b>"Neck jet"</b> symbol via the arrow key and press the <b>"ON/OFF"</b> key. After the operating time has expired or been prematurely terminated, a signal tone is output (2 sec.).</p>	<p><b>Durata del massaggio:</b></p> <ol style="list-style-type: none"> <li>1. Con il tasto a freccia (verso sinistra o verso destra) portare il cursore sul simbolo <b>"Getto sulla nuca"</b>. Confermare la selezione con il tasto dell'asterisco.</li> <li>2. Impostare il tempo (preimpostazione: 20 minuti) con il tasto "+" o "-". Tenendo premuto il tasto "+" o "-", l'aumento o la diminuzione dei minuti viene visualizzato seguito da una <b>"d"</b>. Confermare la selezione con il tasto dell'asterisco.</li> </ol> <p><b>Avvertenza:</b> </p> <p>Durata minima: 5 minuti.  Durata massima: 60 minuti.</p> <p>Le impostazioni vengono salvate nel sistema fino alla programmazione successiva!  In caso di black-out le impostazioni vanno perdute!</p> <p>Per disattivare il funzionamento, con i tasti a freccia portare il cursore sul simbolo <b>"Getto sulla nuca"</b> e quindi premere il tasto <b>"ON/OFF"</b>. Al termine del tempo di funzionamento o se il funzionamento viene disattivato prima del tempo programmato viene emesso un segnale acustico (2 secondi).</p>



Deutsch	English	Italiano
<p> <b>Dampfbad (falls vorhanden!)</b></p> <p>Diese Funktion ermöglicht es ein Dampfbad bei einer Temperatur von 35 bis 50 °C zu nehmen.</p> <p><b>Programmfunktion:</b></p> <ul style="list-style-type: none"> <li>• Zeitfunktion: Dauer des Dampfbades</li> <li>• Temperatureinstellung</li> </ul> <p><b>Warnung!</b> </p> <p><b>Gefahr der Verbrühung</b>  <b>Vor dem Einschalten der Dampffunktion muss der Deckel der Düse so positioniert werden, dass der Dampf in die dem Benutzer entgegengesetzte Richtung entweicht.!</b></p> <p>In den Siebeinsatz des Aromadispenser kann fester Duftstoff eingefüllt werden, z. B. getrocknete Blätter oder auch ein mit Duftstoff getränkter Wattebausch.</p>  <p><b>Dampfbad einschalten (aktivieren)</b></p> <ol style="list-style-type: none"> <li>1. Türe schließen, damit kein Dampf entweichen kann.</li> <li>2. Mit der "Pfeil"-Taste (links oder rechts) den Cursor auf dem "Dampfbad"-Symbol positionieren. Auswahl mit der „ON/OFF“-Taste bestätigen.</li> <li>3. Die Zeit (Voreinstellung zum Beispiel 20 Minuten) mit der Plus-Taste oder Minus-Taste einstellen. Wird die Plus- oder Minustaste gedrückt gehalten, wird die Zu- bzw. Abnahme der Minutenangabe gefolgt von einem "d" angezeigt. Auswahl mit Stern-Taste bestätigen.</li> </ol>	<p> <b>Steam bath (if available!)</b></p> <p>This function enables shower baths at a temperature of 35 to 50 C°.</p> <p><b>Program function:</b></p> <ul style="list-style-type: none"> <li>• Time function: duration of the shower bath</li> <li>• Temperature setting</li> </ul> <p><b>Warning!</b> </p> <p><b>Danger of scald</b>  <b>Before activating the steam function, position the head cover so that the steam will go in the direction opposite the user.</b></p> <p>Solid fragrances can be filled into sieve insert of the aroma dispenser, e.g. dried leaves or also cotton wool soaked in essential oils.</p>  <p><b>Switching on the steam bath (activation)</b></p> <ol style="list-style-type: none"> <li>1. Close the door.</li> <li>2. Position the cursor on the "Steam bath" symbol via the arrow key (left or right). Confirm your selection with the „ON/OFF“ key.</li> <li>3. Set the time (e.g. 20 minutes presetting) via the plus or the minus key. If the plus or the minus key is held depressed, the increase or decrease of the minute setting, followed by a "d", is shown. Confirm your selection with the star key.</li> </ol>	<p> <b>Bagno a vapore (se presente)</b></p> <p>Questa funzione consente di fare un bagno a vapore ad una temperatura di 35 - 50 C°.</p> <p><b>Funzione di programma:</b></p> <ul style="list-style-type: none"> <li>• Funzione temporale: durata del bagno di vapore</li> <li>• Impostazione della temperatura</li> </ul> <p><b>Avvertimento!</b> </p> <p><b>Pericolo di ustioni</b>  <b>Prima di attivare la funzione posizionare il coperchio del diffusore in modo che il va-pore vada in direzione opposta all'utente.</b></p> <p>Nell'inserto filtro dell'Aromadispenser è possibile inserire anche essenza aromatica di tipo solido come, p. es. foglie secche oppure anche un tampone di ovatta impregnato di essenza aromatica.</p>  <p><b>Attivazione del bagno di vapore</b></p> <ol style="list-style-type: none"> <li>1. Chiudere la porta in modo che il vapore non esca all'esterno.</li> <li>2. Con il tasto a freccia (verso sinistra o verso destra) portare il cursore sul simbolo "Bagno di vapore". Confermare la selezione con il tasto „ON/OFF“.</li> <li>3. Impostare il tempo (preimpostazione ad esempio 20 minuti) con il tasto "+" o "-". Tenendo premuto il tasto "+" o "-", l'aumento o la diminuzione dei minuti viene visualizzato seguito da una "d". Confermare la selezione con il tasto asterisco.</li> </ol>



**Elektronisches Bedienelement (Comfort/ Deluxe)**  
**Electronic Operating Element (Comfort/ Deluxe)**  
**Elemento di comando elettronico (Comfort/ Deluxe)**

Deutsch	English	Italiano
<p><b>Hinweis:</b> </p> <p>Mindestdauer: 20 Minuten Höchstdauer: 60 Minuten</p> <p><b>4.</b> Die Leistung mit der Plus-Taste oder Minus-Taste einstellen. Wird die Plus- oder Minus-taste gedrückt, wird die Zu- bzw. Abnahme der Temperaturangabe gefolgt von einem "P" angezeigt. Auswahl mit der Stern-Taste bestätigen.</p>	<p><b>Note:</b> </p> <p>Min. duration: 20 minutes Max. duration: 60 minutes</p> <p><b>4.</b> Adjust the output via the plus or minus key. If the plus or minus key is held depressed, the increase or decrease of the temperature setting, followed by a "P" is shown. Confirm your selection with the star key.</p>	<p><b>Avvertenza:</b> </p> <p>Durata minima: 20 minuti. Durata massima: 60 minuti.</p> <p><b>4.</b> Regolare la potenza con il tasto "+" o "-". Tenendo premuto il tasto "+" o "-", viene visualizzato l'aumento o la diminuzione della temperatura seguito da una "P". Confermare la selezione con il tasto asterisco.</p>
<p><b>Hinweis:</b> </p> <p>Mindestdampfleistung: 65 % Höchstdampfleistung: 99 %</p> <p><b>5.</b> Mit der Pfeil-Taste (links oder rechts) auf das Symbol "Dampfbad" wechseln und mit "ON-/OFF"-Taste bestätigen. Die Kabine kann jetzt verlassen werden.</p>	<p><b>Note:</b> </p> <p>Min. steam output: 65 % Max. steam output: 99 %</p> <p><b>5.</b> Select the "Steam bath" symbol via the arrow key (left or right) and confirm your selection with the "ON/OFF" key. The cabin can now be exited.</p>	<p><b>Avvertenza:</b> </p> <p>Potenza minima di vapore: 65 % Potenza massima di vapore: 99 %</p> <p><b>5.</b> Con i tasti a freccia (verso sinistra o verso destra) passare al simbolo "Bagno a vapore" e confermare con il tasto "ON/OFF". Ora si può uscire dalla cabina.</p>
<p><b>Hinweis:</b> </p> <p>Circa 3 Minuten nach der Aktivierung tritt der Dampf aus. Die Leistung steigt bis zum eingestellten Wert.</p> <p><b>6.</b> Die gewünschte Zeit mit der Stern-Taste bestätigen. <b>7.</b> Die Zeit- und Temperatureinstellung kann während des Betriebs durch Betätigen der Stern-Taste geändert werden. Neuen Wert mit der Stern-Taste bestätigen.</p>	<p><b>Note:</b> </p> <p>The steam is output approx. 3 minutes after activation. The output increases up to the set value.</p> <p><b>6.</b> Confirm the desired duration with the star key. <b>7.</b> The time and temperature settings can be changed during operation by operating the star key. Confirm the new values with the star key.</p>	<p><b>Avvertenza:</b> </p> <p>Dopo circa 3 minuti dall'attivazione inizia a fuoriuscire vapore. La potenza aumenta fino al valore impostato.</p> <p><b>6.</b> Confermare il tempo desiderato con il tasto asterisco. <b>7.</b> L'impostazione del tempo e della temperatura può essere modificata durante il funzionamento premendo il tasto asterisco. Il nuovo valore si conferma con il tasto asterisco.</p>
<p><b>Hinweis:</b> </p> <p>Nach Ablauf der Zeit wird der Dampfaustritt unterbrochen, und das System kehrt in seine Ruhestellung zurück.</p> <p>Die Erwärmungsphase kann maximal 60 Minuten dauern. Wird die eingestellte Temperatur in dieser Zeit nicht erreicht, kehrt das System in seine Ruhestellung zurück.</p> <p>Zum Beenden des Betriebs den Cursor mit der Pfeil-Taste auf das "Dampfbad"-Symbol positionieren, dann "ON-/OFF"-Taste drücken. Nach Ablauf der Betriebszeit oder dem vorzeitigen Beenden des Betriebs ertönt ein Signalton (2 Sek.).</p>	<p><b>Note:</b> </p> <p>After the set duration has expired, the steam output is interrupted and the system returns to its idle position.</p> <p>The heating-up phase may take up to 60 minutes. If the set temperature is not attained within this time, the system returns to its idle position.</p> <p>To stop the operation, position the cursor on the "Steam bath" symbol via the arrow key and press the "ON/OFF" key. After the operating time has expired or been prematurely terminated, a signal tone is output (2 sec.).</p>	<p><b>Avvertenza:</b> </p> <p>Al termine del tempo, la fuoriuscita di vapore si interrompe ed il sistema ritorna nello stato di riposo. La durata massima della fase di riscaldamento è di 60 minuti. Se la temperatura impostata non viene raggiunta entro questo tempo, il sistema ritorna nello stato di riposo. Per disattivare il funzionamento, con i tasti a freccia portare il cursore sul simbolo "Bagno di vapore" e quindi premere il tasto "ON/OFF". Al termine del tempo di funzionamento o se il funzionamento viene disattivato prima del tempo programmato viene emesso un segnale acustico (2 secondi).#</p>
<p><b>Hinweis:</b> </p> <p>Die Unterbrechung findet nur statt, wenn die verbleibende Zeit auf dem Display erscheint!</p>	<p><b>Note:</b> </p> <p>The interruption is only realized if the remaining time is shown on the display!</p>	<p><b>Avvertenza:</b> </p> <p>L'interruzione avviene solo se sul display compare il tempo restante!</p>













Deutsch	English	Italiano
<p> <b>"Schottische Dusche"</b>  (Nacken- und Rückenmassage)</p> <p>Die <b>"Schottische Dusche"</b> aktiviert das abwechselnde Austreten von warmem und kaltem Wasser. Dies ist eine wirksame Methode, um "Form" und "Wohlbefinden" zu verbessern.</p> <p>Die <b>"Schottische Dusche"</b> kann während des Betriebs der <b>"Back Rain"</b>-Funktion, <b>"Rückenbrausen"</b>-Funktion und <b>"Nackenjet"</b>-Funktion betrieben werden.</p> <p><b>Programmfunktion:</b></p> <ul style="list-style-type: none"> <li>• Zeitfunktion: Dauer der Kaltwasserbeimischung</li> <li>• Persönliche Einstellungen: <ul style="list-style-type: none"> <li>- Wechselduschen</li> </ul> </li> </ul> <p><b>Mögliche Programme in Verbindung mit "Black Rain":</b></p> <p><b>Programm 1</b></p> <p>Jedes Brausenpaar gibt über 70% der Zeit warmes Wasser und 30% der Zeit kaltes Wasser ab.</p> <p><b>Programm 2</b></p> <p>Während des zyklischen Umschaltens tritt nacheinander aus einem Brausenpaar kaltes und aus einem anderen warmes Wasser aus.</p> <p><b>Programm 3</b></p> <p>Nach drei zyklischen Umschaltungen des Systems tritt bei zwei Zyklen nur warmes Wasser und beim dritten Zyklus kaltes Wasser aus den Brausen aus.</p> <p><b>1.</b> Mit der Pfeil-Taste (links oder rechts) den Cursor auf dem <b>"Schottische Dusche"</b>-Symbol positionieren. Auswahl mit der Stern-Taste bestätigen.</p> <p><b>2.</b> Auf dem Display erscheint die Meldung <b>"Pr 1"</b> (für Programm 1)</p> <p><b>3.</b> Programm 1, 2 oder 3 mit der Plus-Taste oder Minus-Taste auswählen. Auswahl mit der Stern-Taste bestätigen.</p>	<p> <b>"Scotch shower"</b>  (neck and back massage)</p> <p>The <b>"Scotch Shower"</b> activates an alternating output of warm and cold water. This is an effective method to improve your "form" and "wellbeing".</p> <p>The <b>"Scotch shower"</b> is available when the <b>"Back rain"</b>, <b>"back showers"</b> and <b>"Neck jet"</b> functions are in operation.</p> <p><b>Program function:</b></p> <ul style="list-style-type: none"> <li>• Time function: massaging duration</li> <li>• Personal settings: <ul style="list-style-type: none"> <li>- alternating hot and cold showers</li> </ul> </li> </ul> <p><b>Possible programs in connection with "Back rain":</b></p> <p><b>Program 1</b></p> <p>Each shower pair outputs warm water throughout 70 % and cold water throughout 30 % of the shower duration.</p> <p><b>Program 2</b></p> <p>During the cyclical switch-over, cold and warm water is subsequently output by two separate shower pairs.</p> <p><b>Program 3</b></p> <p>After three cyclical system switch-overs, the showers only output warm water during two cycles and cold water during the third cycle.</p> <p><b>1.</b> Position the cursor on the <b>"Scotch shower"</b> symbol via the arrow key (left or right). Confirm your selection with the star key.</p> <p><b>2.</b> The display shows the message <b>"Pr 1"</b> (for program 1).</p> <p><b>3.</b> Select program 1, 2 or 3 via the plus or minus key. Confirm your selection with the star key.</p>	<p> <b>"Doccia scozzese"</b>  (massaggio della nuca e della schiena)</p> <p>La <b>"Doccia scozzese"</b> attiva la fuoriuscita intermittente di acqua calda e fredda, un metodo efficace per migliorare la forma ed il benessere.</p> <p>La <b>"Doccia scozzese"</b> può essere attivata durante il funzionamento a <b>"Pioggia"</b>, <b>"Docce posteriori"</b> e <b>"Getto sulla nuca"</b>.</p> <p><b>Funzione di programma:</b></p> <ul style="list-style-type: none"> <li>• Funzione temporale: durata dell'aggiunta di acqua fredda</li> <li>• Impostazioni personalizzate: <ul style="list-style-type: none"> <li>- Doccia alterna</li> </ul> </li> </ul> <p><b>Programmi possibili in combinazione con "Pioggia":</b></p> <p><b>Programma 1</b></p> <p>Ogni coppia di docce manda acqua calda per il 70% ed acqua fredda per il 30% del tempo.</p> <p><b>Programma 2</b></p> <p>Durante la commutazione ciclica, da una coppia di docce fuoriesce acqua fredda ed, in successione, da un'altra coppia acqua calda.</p> <p><b>Programma 3</b></p> <p>Dopo tre commutazioni cicliche del sistema, per due cicli dalle docce fuoriesce solo acqua calda e durante il terzo ciclo solo acqua fredda.</p> <p><b>1.</b> Con il tasto a freccia (verso sinistra o verso destra) portare il cursore sul simbolo <b>"Doccia scozzese"</b>. Confermare la selezione con il tasto dell'asterisco.</p> <p><b>2.</b> Sul display compare il messaggio <b>"Pr 1"</b> (programma 1)</p> <p><b>3.</b> Con il tasto "+" o "-" selezionare il programma 1, 2 o 3. Confermare la selezione con il tasto dell'asterisco.</p>









**Elektronisches Bedienelement (Deluxe)**  
**Electronic Operating Element (Deluxe)**  
**Elemento di comando elettronico (Deluxe)**

Deutsch	English	Italiano
<p><b>Zu Programm 1:</b></p> <p>1. Auf dem Display erscheint die Meldung "pc" gefolgt von der Prozentzahl zur Zeit (Dauer) der Kaltwasserabgabe.</p> <p>2. Mit der Plus-Taste oder Minus-Taste einen Wert einstellen der zwischen 10% und 70% liegt. Wird die Plus- oder Minustaste gedrückt gehalten, wird die Zu- bzw. Abnahme der Prozentangabe angezeigt. Auswahl mit der Stern-Taste bestätigen.</p> <p>Die Einstellungen werden im System bis zur nächsten Programmierung abgelegt! Bei Unterbrechung der Stromversorgung werden die Einstellungen gelöscht!</p> <p><b>Beispiel:</b></p> <ul style="list-style-type: none"> <li>• Programmauswahl: "Pr 1"</li> <li>• Dauer des "ON-Zyklus": 5 Sekunden (Voreinstellung 5 Sek. / Brause geöffnet)</li> <li>• Kaltwasserabgabe (Dauer): "pc" 40%</li> <li>• Zyklische Umschaltung: Brause 1 + 2 + 3 + 4: 2 Sekunden kaltes Wasser (40% der Gesamtzeit) 3 Sekunden warmes Wasser (60% der Gesamtzeit).</li> </ul> <p><b>Zu Programm 2:</b></p> <p>1. Programm auswählen</p> <p><b>Hinweis:</b> </p> <p>Bei Programm 2 ist eine persönliche Einstellung nicht notwendig. Das Programm startet automatisch mit dem Austritt von kaltem Wasser aus einem Brausenpaar und warmen Wasser aus den anderen drei Brausenpaaren. Umlaufend tritt aus allen Strahlerpaaren einen Zyklus lang kaltes Wasser aus, während aus den anderen warmes Wasser austritt.</p> <p>2. Auswahl mit der Stern-Taste bestätigen.</p> <p><b>Programmierungsbeispiele</b> (individuelle Einstellungen)</p> <p>1. Gewünschtes Programm: "Pr2"</p> <p>2. Zyklusumschaltung wie folgt:</p>	<p><b>Ref. to program 1:</b></p> <p>1. The display shows the message "pc", followed by a percentage of the cold water output's time (duration).</p> <p>2. Use the plus or minus key to set a value between 10% and 70%. If the plus or minus key is held depressed, the increase or decrease of the percentage indication is shown. Confirm your selection with the star key. The settings are stored in the system until the next programming!</p> <p>If the power supply is interrupted, the settings are deleted!</p> <p><b>Example:</b></p> <ul style="list-style-type: none"> <li>• Program selection: "Pr 1"</li> <li>• Duration of the "ON cycle": 5 seconds (presetting 5 sec. / shower open)</li> <li>• Cold water output (duration): "pc" 40%</li> <li>• Cyclical switchover: Shower 1 + 2 + 3 + 4: Cold water for 2 seconds (40% of the total time), warm water for 3 seconds (60% of the total time).</li> </ul> <p><b>Ref. to program 2:</b></p> <p>1. Select the program.</p> <p><b>Note:</b> </p> <p>With program 2, a personal setting need not be made. The program automatically starts with outputting cold water via one shower pair and warm water via the other three shower pairs. Rotatingly, all shower pairs output cold water during one cycle and warm water during another cycle.</p> <p>2. Confirm your selection with the star key.</p> <p><b>Programming examples</b> (individual settings)</p> <p>1. Desired program: "Pr2"</p> <p>2. Cycle switchover as follows:</p>	<p><b>Programma 1:</b></p> <p>1. Sul display compare il messaggio "pc" seguito dalla percentuale del tempo (durata) della mandata di acqua fredda.</p> <p>2. Con il tasto "+" o "-" impostare un valore compreso tra 10% e 70%. Tenendo premuto il tasto "+" o "-" viene visualizzato l'aumento o la riduzione del valore percentuale. Confermare la selezione con il tasto dell'asterisco.</p> <p>Le impostazioni vengono salvate nel sistema fino alla programmazione successiva! In caso di black-out le impostazioni vanno perse!</p> <p><b>Esempio:</b></p> <ul style="list-style-type: none"> <li>• Selezione del programma: "Pr 1"</li> <li>• Durata del "ciclo ON": 5 secondi (preimpostazione 5 secondi / doccia aperta)</li> <li>• Mandata di acqua fredda (durata): "pc" 40%</li> <li>• Commutazione ciclica: Docce 1 + 2 + 3 + 4: 2 secondi acqua fredda (40% del tempo totale) e 3 secondi di acqua calda (60% del tempo totale).</li> </ul> <p><b>Programma 2:</b></p> <p>1. Selezionare il programma</p> <p><b>Avvertenza:</b> </p> <p>Per il programma 2 non è necessaria un'impostazione personalizzata. Il programma si avvia automaticamente con la fuoriuscita di acqua fredda da una coppia di docce e di acqua calda dalle altre tre coppie di docce. Da tutte le coppie di ugelli fuoriesce un ciclo lungo di acqua fredda, mentre dalle altre fuoriesce acqua calda.</p> <p>2. Confermare la selezione con il tasto dell'asterisco.</p> <p><b>Esempi di programmazione</b> (impostazioni personalizzate)</p> <p>1. Programma desiderato: "Pr2"</p> <p>2. Commutazione del ciclo nel modo seguente:</p>







Deutsch	English	Italiano
<p><b>Zyklus 1:</b>  Brause 1: kaltes Wasser  Brause 2: warmes Wasser  Brause 3: warmes Wasser  Brause 4: warmes Wasser</p> <p><b>Zyklus 2:</b>  Brause 1: warmes Wasser  Brause 2: kaltes Wasser  Brause 3: warmes Wasser  Brause 4: warmes Wasser</p> <p><b>Zyklus 3:</b>  Brause 1: warmes Wasser  Brause 2: warmes Wasser  Brause 3: kaltes Wasser  Brause 4: warmes Wasser</p> <p><b>Zyklus 4:</b>  Brause 1: warmes Wasser  Brause 2: warmes Wasser  Brause 3: warmes Wasser  Brause 4: kaltes Wasser</p> <p><b>Zu Programm 3:</b>  <b>1.</b> Auf dem Display erscheint die Meldung "ci" gefolgt von der Anzahl der Warmwasser-Zyklen (2 bis 9).  <b>2.</b> Mit der Plus-Taste oder Minus-Taste einen Wert einstellen und mit der Stern-Taste bestätigen.</p> <p><b>Hinweis:</b> </p> <p>Ein Warmwasserzyklus wird immer gefolgt von einem Kaltwasserzyklus.  Die Einstellungen werden im System bis zur nächsten Programmierung abgelegt!  Bei Unterbrechung der Stromversorgung werden die Einstellungen gelöscht!</p> <p><b>Programmierungsbeispiele</b>  (individuelle Einstellungen)  1. Gewünschtes Programm: <b>"Pr3"</b>  2. Anzahl der Zyklen mit Warmwasseraustritt  3. Zyklusumschaltung wie folgt:</p>	<p><b>Cycle 1:</b>  Shower 1: cold water  Shower 2: warm water  Shower 3: warm water  Shower 4: warm water</p> <p><b>Cycle 2:</b>  Shower 1: warm water  Shower 2: cold water  Shower 3: warm water  Shower 4: warm water</p> <p><b>Cycle 3:</b>  Shower 1: warm water  Shower 2: warm water  Shower 3: cold water  Shower 4: warm water</p> <p><b>Cycle 4:</b>  Shower 1: warm water  Shower 2: warm water  Shower 3: warm water  Shower 4: cold water</p> <p><b>Ref. to program 3:</b>  <b>1.</b> The display shows the message "ci", followed by the number of warm water cycles (2 to 9).  <b>2.</b> Use the plus or minus key to set a value and confirm your selection with the star key.</p> <p><b>Note:</b> </p> <p>A warm water cycle is always followed by a cold water cycle.</p> <p>The settings are stored in the system until the next programming!  If the power supply is interrupted, the settings are deleted!</p> <p><b>Programming examples</b>  (individual settings)  1. Desired program: <b>"Pr3"</b>  2. Number of cycles with warm water output  3. Cycle switchover as follows:</p>	<p><b>Ciclo 1:</b>  Doccia 1: acqua fredda  Doccia 2: acqua calda  Doccia 3: acqua calda  Doccia 4: acqua calda</p> <p><b>Ciclo 2:</b>  Doccia 1: acqua calda  Doccia 2: acqua fredda  Doccia 3: acqua calda  Doccia 4: acqua calda</p> <p><b>Ciclo 3:</b>  Doccia 1: acqua calda  Doccia 2: acqua calda  Doccia 3: acqua fredda  Doccia 4: acqua calda</p> <p><b>Ciclo 4:</b>  Doccia 1: acqua calda  Doccia 2: acqua calda  Doccia 3: acqua calda  Doccia 4: acqua fredda</p> <p><b>Programma 3:</b>  <b>1.</b> Sul display compare il messaggio "ci" seguito dal numero di cicli con acqua calda (da 2 a 9).  <b>2.</b> Con il tasto "+" o "-" impostare un valore e confermare con il tasto dell'asterisco.</p> <p><b>Avvertenza:</b> </p> <p>Un ciclo con acqua calda è sempre seguito da un ciclo con acqua fredda.  Le impostazioni vengono salvate nel sistema fino alla programmazione successiva!  In caso di black-out le impostazioni vanno perse!</p> <p><b>Esempi di programmazione</b>  (impostazioni personalizzate)  1. Programma desiderato: <b>"Pr3"</b>  2. Numero di cicli con fuoriuscita di acqua calda  3. Commutazione del ciclo nel modo seguente:</p>

**Elektronisches Bedienelement (Deluxe)**  
**Electronic Operating Element (Deluxe)**  
**Elemento di comando elettronico (Deluxe)**

Deutsch	English	Italiano
<p><b>Zyklus 1:</b>  Brause 1: warmes Wasser  Brause 2: warmes Wasser  Brause 3: warmes Wasser  Brause 4: warmes Wasser</p> <p><b>Zyklus 2:</b>  Brause 1: warmes Wasser  Brause 2: warmes Wasser  Brause 3: warmes Wasser  Brause 4: warmes Wasser</p> <p><b>Zyklus 3:</b>  Brause 1: warmes Wasser  Brause 2: warmes Wasser  Brause 3: warmes Wasser  Brause 4: warmes Wasser</p> <p><b>Zyklus 4:</b>  Brause 1: kaltes Wasser  Brause 2: kaltes Wasser  Brause 3: kaltes Wasser  Brause 4: kaltes Wasser</p> <p><b>Hinweis:</b> </p> <p><b>Zusätzlich muss eine der Funktionen aktiviert werden:</b></p> <p> <b>"Back Rain" Funktion</b>  (Ganzkörpermassage)</p> <p> <b>"Rückenbrausen" Funktion</b>  (Rückenmassage)</p> <p> <b>"Nackenjet" Funktion</b>  (Nacken- und Rückenmassage)</p> <p><b>3.</b> Mit der Pfeil-Taste (links oder rechts) auf das Symbol "Schottische-Dusche" wechseln und mit "ON-/OFF"-Taste bestätigen.</p> <p>Nach Ablauf der Betriebszeit oder dem vorzeitigen Beenden des Betriebs ertönt ein Signalton (2 Sek.).</p>	<p><b>Cycle 1:</b>  Shower 1: warm water  Shower 2: warm water  Shower 3: warm water  Shower 4: warm water</p> <p><b>Cycle 2:</b>  Shower 1: warm water  Shower 2: warm water  Shower 3: warm water  Shower 4: warm water</p> <p><b>Cycle 3:</b>  Shower 1: warm water  Shower 2: warm water  Shower 3: warm water  Shower 4: warm water</p> <p><b>Cycle 4:</b>  Shower 1: cold water  Shower 2: cold water  Shower 3: cold water  Shower 4: cold water</p> <p><b>Note:</b> </p> <p><b>In addition, one of the following functions must be activated:</b></p> <p> <b>"Back rain" function</b>  (whole-body massage)</p> <p> <b>"back showers" function</b>  (back massage)</p> <p> <b>"Neck jet" function</b>  (neck and back massage)</p> <p><b>3.</b> Select the "Scotch shower" symbol via the arrow key (left or right) and confirm your selection with the "ON/OFF" key.</p> <p>After the operating time has expired or been prematurely terminated, a signal tone is output (2 sec.).</p>	<p><b>Ciclo 1:</b>  Doccia 1: acqua calda  Doccia 2: acqua calda  Doccia 3: acqua calda  Doccia 4: acqua calda</p> <p><b>Ciclo 2:</b>  Doccia 1: acqua calda  Doccia 2: acqua calda  Doccia 3: acqua calda  Doccia 4: acqua calda</p> <p><b>Ciclo 3:</b>  Doccia 1: acqua calda  Doccia 2: acqua calda  Doccia 3: acqua calda  Doccia 4: acqua calda</p> <p><b>Ciclo 4:</b>  Doccia 1: acqua fredda  Doccia 2: acqua fredda  Doccia 3: acqua fredda  Doccia 4: acqua fredda</p> <p><b>Avvertenza:</b> </p> <p><b>È necessario attivare anche una delle funzioni:</b></p> <p> <b>Funzione "Pioggia"</b>  (massaggio integrale)</p> <p> <b>Funzione "docce posteriori"</b>  (massaggio della schiena)</p> <p> <b>Funzione "Getto sulla nuca"</b>  (massaggio della nuca e della schiena)</p> <p><b>3.</b> Con i tasti a freccia (verso sinistra o verso destra) passare al simbolo "Doccia scozzese" e confermare con il tasto "ON/OFF".</p> <p>Al termine del tempo di funzionamento o se il funzionamento viene disattivato prima del tempo programmato viene emesso un segnale acustico (2 secondi).</p>

Deutsch	English	Italiano
<p> <b>"Radio" (falls vorhanden!)</b> (Ausgabe über Deckenlautsprecher)</p> <p><b>1.</b> Mit der Pfeil-Taste (links oder rechts) den Cursor auf dem <b>"Radio"</b>-Symbol positionieren. Mit der <b>"ON-/OFF"</b>-Taste bestätigen.</p> <p>Die Funktion ist jetzt aktiv. Im Display erscheint die Meldung "On".</p> <p><b>2.</b> Die Lautstärke (1 - 20) mit der Plus-Taste oder der Minus-Taste einstellen.</p> <p><b>Hinweis:</b> </p> <p>Stern-Taste drücken. Die Frequenz und die Speicherplätze (1-8) werden angezeigt.</p> <p><b>3.</b> Mit der Pfeil-Taste (links oder rechts) den gewünschten Speicherplatz auswählen (1-8).</p> <p><b>4.</b> Mit der Plus-Taste oder Minus-Taste die gewünschte Radio-Frequenz auswählen. Auswahl mit der Stern-Taste bestätigen.</p> <p><b>Hinweis:</b> </p> <p>7 x Speicherplätze noch frei! Weitere Belegung: gleiche Vorgehensweise!</p> <p><b>Radio-Sender (Programme) aufrufen:</b></p> <p><b>1.</b> Mit der Pfeil-Taste (links oder rechts) den Cursor auf dem <b>"Radio"</b>-Symbol positionieren. Mit der <b>"ON-/OFF"</b>-Taste bestätigen.</p> <p><b>2.</b> Stern-Taste drücken und mit der Pfeil-Taste (links oder rechts) das gewünschte Programm (Radiosender 1-8) auswählen. Mit der <b>"ON-/OFF"</b>-Taste bestätigen.</p> <p>Zum Beenden des Betriebs den Cursor mit der Pfeil-Taste auf dem <b>"Radio"</b>-Symbol positionieren, dann <b>"ON-/OFF"</b>-Taste drücken. Nach dem Beenden des Betriebs ertönt ein Signalton (2 Sek.). Im Display erscheint die Meldung "Off".</p>	<p> <b>"Radio" (if available!)</b> (output via roof loudspeaker)</p> <p><b>1.</b> Position the cursor on the <b>"Radio"</b> symbol via the arrow key (left or right). Confirm your selection with the <b>"ON/OFF"</b> key.</p> <p>The function is now active. The message "On" is shown on the display.</p> <p><b>2.</b> Set the sound volume (1 - 20) via the plus or minus key.</p> <p><b>Note:</b> </p> <p>Press the star key. The frequency and the memory locations (1-8) are shown.</p> <p><b>3.</b> Select the desired memory location (1-8) via the arrow key (left or right).</p> <p><b>4.</b> Select the desired radio frequency via the plus or minus key. Confirm your selection with the star key.</p> <p><b>Note:</b> </p> <p>7 x memory locations unassigned! Further assignment: same procedure!</p> <p><b>Calling up radio stations (programs):</b></p> <p><b>1.</b> Position the cursor on the <b>"Radio"</b> symbol via the arrow key (left or right). Confirm your selection with the <b>"ON/OFF"</b> key.</p> <p><b>2.</b> Press the star key and select the desired program (radio station 1-8) via the arrow key (left or right). Confirm your selection with the <b>"ON/OFF"</b> key.</p> <p>To stop the operation, position the cursor on the <b>"Radio"</b> symbol via the arrow key and press the <b>"ON/OFF"</b> key. After termination of the operation, a signal tone is output (2 sec.). The message "Off" is shown on the display.</p>	<p> <b>"Radio" (se presente)</b> (audio tramite l'altoparlante in alto)</p> <p><b>1.</b> Con il tasto a freccia (verso sinistra o verso destra) portare il cursore sul simbolo <b>"Radio"</b>. Confermare con il tasto <b>"ON/OFF"</b>.</p> <p>Ora la funzione è attiva. Sul display compare il messaggio "On".</p> <p><b>2.</b> Regolare il volume (1 - 20) con i tasti "+" e "-".</p> <p><b>Avvertenza:</b> </p> <p>Premere il tasto asterisco. Vengono visualizzate la frequenza e le locazioni di memoria (1-8).</p> <p><b>3.</b> Con il tasto a freccia (verso sinistra o verso destra) selezionare una locazione di memoria (1-8).</p> <p><b>4.</b> Con il tasto "+" o "-" selezionare la frequenza radio desiderata. Confermare la selezione con il tasto asterisco.</p> <p><b>Avvertenza:</b> </p> <p>7 locazioni di memoria ancora libere! Programmazione delle altre locazioni di memoria: stesso procedimento!</p> <p><b>Sintonizzazione sull'emittente radio (programma):</b></p> <p><b>1.</b> Con il tasto a freccia (verso sinistra o verso destra) portare il cursore sul simbolo <b>"Radio"</b>. Confermare con il tasto <b>"ON/OFF"</b>.</p> <p><b>2.</b> Premere il tasto asterisco e con i tasti a freccia (verso sinistra o verso destra) selezionare il programma desiderato (emittenti 1-8). Confermare con il tasto <b>"ON/OFF"</b>.</p> <p>Per disattivare il funzionamento, con i tasti a freccia portare il cursore sul simbolo <b>"Radio"</b> e quindi premere il tasto <b>"ON/OFF"</b>. Al termine del funzionamento viene emesso un segnale acustico (2 secondi). Sul display compare il messaggio "Off".</p>





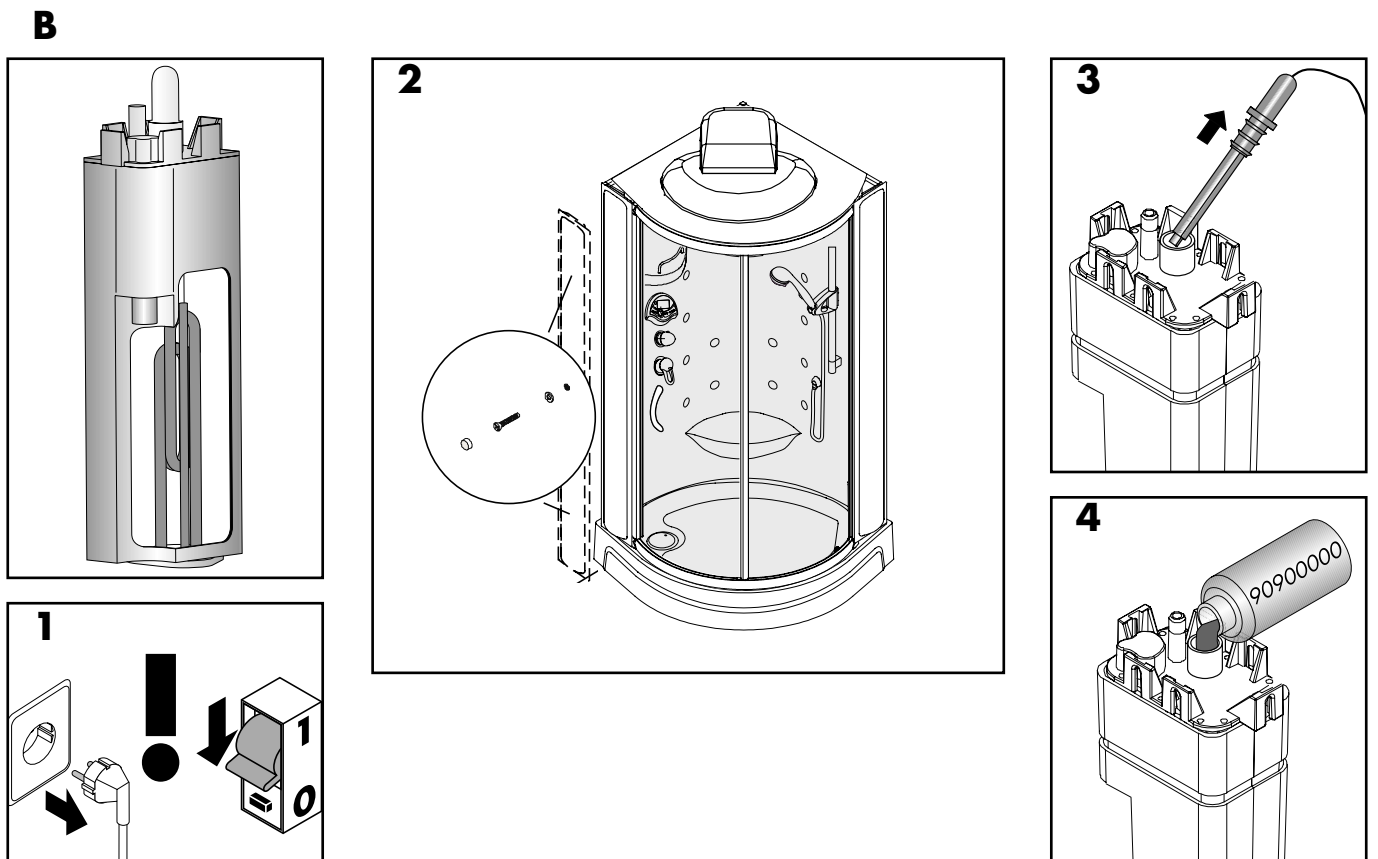
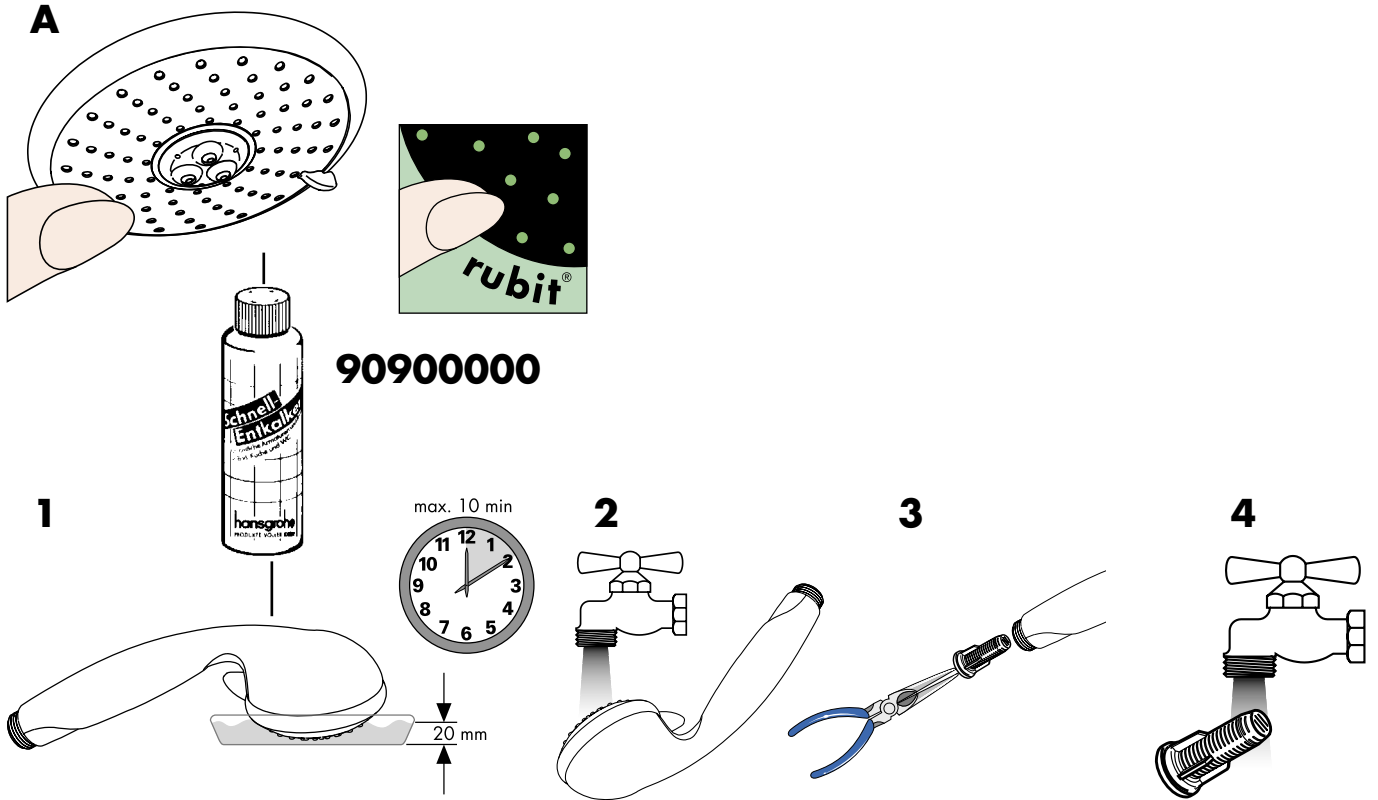

**Elektronisches Bedienelement (Deluxe)**  
**Electronic Operating Element (Deluxe)**  
**Elemento di comando elettronico (Deluxe)**

Deutsch	English	Italiano
<p> <b>"Chromotherapie" (falls vorhanden!)</b> (Lichttherapie für das Wohlbefinden)</p> <p><b>Vorsicht!</b> </p> <p><b>Gefahr der Augenentzündung</b> Nicht längere Zeit in das Beleuchtungselement schauen!</p> <p><b>1.</b> Mit der Pfeil-Taste (links oder rechts) den Cursor auf dem <b>"Chromotherapie"</b>-Symbol positionieren. Mit der <b>"ON-/OFF"</b>-Taste bestätigen.</p> <p><b>2.</b> Die Funktion ist jetzt aktiv. Im Display erscheint die Meldung "C7" ("C7" steht für Weißlicht).</p> <p><b>Auswahl folgender Zyklen möglich:</b>  C1: Vorführ Zyklus  C2: Entspannender Zyklus  C3: Anregender Zyklus  C4: Regenerierender Zyklus  C5: Erfrischender Zyklus  C6: Aufheiternder Zyklus  C7: Weißlicht</p> <p>Mit der Plus-Taste oder Minus-Taste gewünschtes Licht auswählen.</p> <p>Zum Beenden der Funktion den Cursor mit der <b>"Pfeil"</b>-Taste auf das <b>"Chromotherapie"</b>-Symbol positionieren, dann <b>"ON-/OFF"</b>-Taste drücken.</p> <p>Der Vorführ-Zyklus (gedacht für Messen und Ausstellung) läuft nach dem Einschalten kontinuierlich, bis er wieder manuell ausgeschaltet wird.  Die Zyklen C2 bis C6 dauern 60 Minuten, der Zyklus C7 30 Minuten. Danach schaltet das Licht automatisch aus.</p>	<p> <b>"Chromo therapy" (if available!)</b> (light therapy for wellbeing)</p> <p><b>Caution!</b> </p> <p><b>Danger of eye soreness</b> Do not look into the illumination element for a longer period of time!</p> <p><b>1.</b> Position the cursor on the <b>"Chromo therapy"</b> symbol via the arrow key (left or right). Confirm your selection with the <b>"ON/OFF"</b> key.</p> <p><b>2.</b> The function is now active. The message "C7" is shown on the display ("C7" stands for white light).</p> <p><b>The following cycles can be selected:</b>  C1: Presentation cycle  C2: Relaxing cycle  C3: Stimulating cycle  C4: Regenerating cycle  C5: Refreshing cycle  C6: Exhilaratory cycle  C7: White light</p> <p>Select the desired light via the plus or minus key.</p> <p>To stop the function, position the cursor on the <b>"Chromo therapy"</b> symbol via the <b>"Arrow"</b> key and press the <b>"ON/OFF"</b> key.</p> <p>The presentation cycle (intended for trade fairs and exhibitions) continuously runs after switch-on until it is manually switched back off.  Cycles C2 to C6 run for 60 minutes, cycle C7 runs for 30 minutes. After expiration of this time, the light automatically extinguishes.</p>	<p> <b>Cromoterapia (se presente)</b> (luce terapia per il benessere)</p> <p><b>Attenzione!</b> </p> <p><b>Pericolo di infiammazione agli occhi</b> Non guardare a lungo l'elemento di illuminazione!</p> <p><b>1.</b> Con il tasto a freccia (verso sinistra o verso destra) portare il cursore sul simbolo <b>"Cromoterapia"</b>. Confermare con il tasto <b>"ON/OFF"</b>.</p> <p><b>2.</b> Ora la funzione è attiva. Sul display compare il messaggio "C7" ("C7" indica luce bianca).</p> <p><b>È possibile selezionare i seguenti cicli:</b>  C1: Ciclo di presentazione  C2: ciclo rilassante  C3: ciclo eccitante  C4: ciclo rigenerante  C5: ciclo rinfrescante  C6: ciclo rasserenante  C7: luce bianca</p> <p>Selezionare la luce desiderata con il tasto "+" o "-".</p> <p>Per disattivare la funzione, con il tasto a <b>freccia</b> portare il cursore sul simbolo <b>"Cromoterapia"</b> e quindi premere il tasto <b>"ON/OFF"</b>.</p> <p>In seguito alla sua attivazione, il ciclo di presentazione (previsto per fiere ed esposizioni) continua automaticamente fino alla sua disattivazione manuale.  I cicli da C2 a C6 durano 60 minuti, il ciclo C7 invece 30 minuti. Al termine, la luce si spegne automaticamente.</p>



Deutsch	English	Italiano
<p><b>Reinigung der Hand- und Kopfbrause</b> (Abb. A)  Mit "rubit®", der manuellen Reinigungsfunktion, können die Strahlformer durch einfaches Rubbeln vom Kalk befreit werden.</p> <p><b>Reinigung der Handbrause</b> (Abb. A)  Mistral 3 Handbrause mit "Quiclean", der Reinigungsfunktion gegen Kalk. Beim Umstellen der Strahlarten entfernen kleine Reinigungsstifte die Kalkablagerungen.</p> <p><b>Entkalken des Dampfgenerators</b> (Abb. B)</p> <p><b>Vorsicht!</b> </p> <p>Um die Entkalkungsintervalle zu verlängern, bzw. Ihre Hausinstallation vor Schäden zu bewahren, muss ab 14° dH (~2,5 mmol/l) eine zentrale Enthärtungsanlage eingebaut werden.</p> <p><b>Wann sollte entkalkt werden:</b></p> <ul style="list-style-type: none"> <li>• die Dampfleistung lässt nach</li> <li>• das Erreichen der ausgewählten Kabinentemperatur dauert länger wie bisher</li> <li>• während des Dampfbetriebs kommt heißes Wasser aus der Düse</li> </ul> <p><b>Entkalken</b> (Abb. B):</p> <ul style="list-style-type: none"> <li>• elektrische Energiezufuhr abschalten</li> <li>• Linke Seitenverkleidung demontieren</li> <li>• Wasserstandsensor aus dem Gehäuse des Dampfgenerators ziehen und ca. 2 l Hansgrohe Schnellentkalker (Art. Nr. 90901000) einfüllen. Wasserstandsensor wieder einführen. Den Entkalker ca. 1 Stunde einwirken lassen.</li> </ul> <p><b>Bedienelement Steam:</b></p> <ul style="list-style-type: none"> <li>• Energiezufuhr anschalten, die Dampffunktion aktivieren und nach ca. 30 sec wieder ausschalten. Der Dampfgenerator entleert sich.</li> </ul> <p><b>Bedienelement Deluxe:</b></p> <ul style="list-style-type: none"> <li>• Energiezufuhr anschalten, mit der „Pfeil“-Taste den Cursor auf dem „Dampfbad“-Symbol positionieren und Auswahl mit der „ON/OFF“-Taste bestätigen. Nach ca. 5 sec. Dampffunktion wieder beenden. Der Dampfgenerator entleert sich. (Die Bedienung des Bedienelements kann in dieser Montageanleitung nachgelesen werden.)</li> </ul> <p><b>Vorsicht!</b> </p> <p>Zum kompletten ausspülen des Schnellentkalkers Dampfgenerator mehrmals aktivieren und entleeren.</p> <ul style="list-style-type: none"> <li>• Seitenverkleidung wieder anbringen.</li> </ul>	<p><b>Cleaning the hand and head shower</b> (Fig. A)  With the manual cleaning function "rubit®", jet former calcinations can be removed by simple rubbing.</p> <p><b>Cleaning the hand shower</b> (Fig. A)  Mistral 3 hand shower with "Quiclean", the cleaning function against calcinations. When the jet types are changed, small cleaning pins remove the calcinations.</p> <p><b>Decalcifying of steam generator</b> (Fig. B)</p> <p><b>Caution!</b> </p> <p>If your water has a hardness degree of 14 (~2,5 mmol/l) or higher, a water softening system must be integrated in the water supply to extend the decalcifying intervals resp. to save your domestic installation!</p> <p><b>Decalcifying the steam generator:</b></p> <ul style="list-style-type: none"> <li>• if the steam power gets low</li> <li>• if it takes longer to achieve the chosen cabin temperature like until now</li> <li>• if hot water comes out of the steam nozzle during the operating time</li> </ul> <p><b>Decalcifying</b> (Abb. B):</p> <ul style="list-style-type: none"> <li>• turn off the electrical supply</li> <li>• disassemble the left side</li> <li>• Pull out the water level sensor from the box of steam generator, pour in Hansgrohe's Decalcifying Agent (90901000) (approx. 2 l) and wait circa 1 hour.</li> </ul> <p><b>Operating Element Steam:</b></p> <ul style="list-style-type: none"> <li>• To drain the steam generator, turn on electrical supply, activate the steam switch and switch it once more again after approx. 30 sec.</li> </ul> <p><b>Operating Element Deluxe:</b></p> <ul style="list-style-type: none"> <li>• To drain the steam generator, turn on electrical supply, position the cursor on the "Steam bath" symbol, confirm your selection with the „ON/OFF“ ke. Stop the operation after 5 sec. (How to use the operating element is described in this installation instruction.)</li> </ul> <p><b>Caution!</b> </p> <p>Activate the steam operating severals times to drain out the completely decalcifying agent.</p> <ul style="list-style-type: none"> <li>• Installing the side casing.</li> </ul>	<p><b>Pulizia della doccia manuale e soffione</b> (fig. A)  Con "rubit®" e la funzione di pulizia manuale, basta strofinare per eliminare il calcare dagli elementi di acciaio).</p> <p><b>Pulizia della doccia manuale</b> (fig. A)  Doccia manuale Mistral 3 con "Quiclean", la funzione di pulizia contro il calcare. Nel passaggio ad un altro tipo di getto, piccole punte di pulizia rimuovono il calcare.</p> <p><b>Togliere il calcare dal generatore di vapore</b> (fig. B)</p> <p><b>Cautela!</b> </p> <p>In caso di acqua dura (14° o più), è necessario dotarsi di un apparecchio di dolcificazione dell'acqua, da inserire in prossimità delle condutture idrauliche, per evitare danni alle installazioni.</p> <p><b>Togliere il calcare dal generatore di vapore:</b></p> <ul style="list-style-type: none"> <li>• se l'intensità del diffusore di vapore è ridotta al minimo.</li> <li>• se per raggiungere una determinata temperatura all'interno della cabina si deve attendere a lungo.</li> <li>• se dal diffusore di vapore esce acqua calda durante la funzione del bagno di vapore.</li> </ul> <p><b>Per togliere il calcare</b> (Abb. B):</p> <ul style="list-style-type: none"> <li>• togliere corrente elettrica all'idrocabina.</li> <li>• Togliere la parete ispezionabile sinistra</li> <li>• Estrarre il sensore di livello dell'acqua dalla scatola del generatore di vapore e immergerlo nel liquido anticalcare Hansgrohe (Art. Nr. 90901000). Aspettare circa un'ora.</li> </ul> <p><b>Elementi di comando bagno di vapore:</b></p> <ul style="list-style-type: none"> <li>• Per svuotare il generatore di vapore, attivare la corrente elettrica, premere il pulsante del bagno di vapore e dopo circa 30 secondi riprenderlo nuovamente.</li> </ul> <p><b>Elementi di comando Deluxe:</b></p> <ul style="list-style-type: none"> <li>• Per svuotare il generatore di vapore, attivare la corrente elettrica, posizionare il cursore sul simbolo „Bagno di vapore“ e confermare la selezione con il tasto „ON/OFF“. La funzione si arresta dopo 5 secondi. (Per l'uso dei sistemi di comando consultare le istruzioni per l'installazione).</li> </ul> <p><b>Cautela!</b> </p> <p>Attivare i comandi del bagno di vapore molte volte per drenare completamente gli agenti anti calcare.</p> <ul style="list-style-type: none"> <li>• Riassemblare il pannello ispezionabile.</li> </ul>



Deutsch	English	Italiano
<p><b>Prüfung der Elektrik</b>  Sollten Störungen in der Stromversorgung auftreten, bitte folgende Prüfabläufe durchführen:</p> <p><b>Elektriker!</b> </p> <p>Arbeiten an der elektrischen Anlage dürfen nur von Fachpersonal durchgeführt werden.</p> <ol style="list-style-type: none"> <li>1. Schalter eingeschaltet (funktionstüchtig).</li> <li>2. Stromversorgung vorhanden. Anschluss an das Stromnetz prüfen.</li> </ol> <p><b>Gefahr!</b> </p> <p>Vor dem Öffnen der Steuerung Strom abschalten (Dampfdusche vom Stromnetz trennen)!</p>	<p><b>Inspecting the electrics</b>  In case of any power supply failures, please carry out the following inspection procedures:</p> <p><b>Electrician!</b> </p> <p>Work at the electrical system may only be carried out by expert personnel.</p> <ol style="list-style-type: none"> <li>1. Make sure the power supply is switched on (operable).</li> <li>2. Power supply available. Check the power supply connection.</li> </ol> <p><b>Danger!</b> </p> <p>Disconnect the power supply before opening the control box (disconnect the steam shower from the power supply)!</p>	<p><b>Controllo dell'impianto elettrico</b>  Se si presentano anomalie dell'alimentazione elettrica, eseguire i seguenti controlli:</p> <p><b>Elettricista!</b> </p> <p>Gli interventi sull'impianto elettrico devono essere eseguiti solo da un tecnico qualificato.</p> <ol style="list-style-type: none"> <li>1. Interruttore inserito (funzionante).</li> <li>2. Tensione elettrica applicata. Controllare il collegamento alla rete elettrica.</li> </ol> <p><b>Pericolo!</b> </p> <p>Prima di aprire la centralina staccare la tensione (staccare la doccia a vapore dalla rete elettrica)!</p>



**Adressen  
Addresses  
Indirizzi**

**A**  
Hansgrohe  
Postfach 85  
2355 Wr. Neudorf  
Telefon: 0 22 36 / 6 28 30  
Telefax: 0 22 36 / 62 83 019

**D**  
Hansgrohe  
D-77757  
Schiltach / Schwarzwald  
Telefon: 0 78 36 / 51-0  
Telefax: 0 78 36 / 51 13 00

**F**  
Hansgrohe  
6/8 rue Henri-Poincaré Z. A.  
92167 Antony Cedex  
Téléphone: 01 40 96 40 00  
Télécopie: 01 46 66 49 89

**HR** **BiH** **YU**  
Hansgrohe  
Omega Nova-Sibenik D.O.O.  
K.Zvonimira BB  
22000 Sibenik  
Telefon: 00 385/(0)22/310 450  
Telefax: 00 385/(0)22/330 221

**NL**  
Pharo Nederland  
Cleopatra B.V.  
Handelsweg 45  
NL - 1525 RG Westknollendam  
Telefoon: 075 6478200  
Telefax: 075 6478500

**RO**  
Representative Office  
Apsa Sasori  
Bd.O.Goga nr.4(106),bl M26,sc.3,ap.68  
7000 Bucuresti  
Romania  
Tel./Fax: (0040) 0 21 326 10 01

**SLO**  
Representative Office Hansgrohe  
Riharjeva 2  
1000 Ljubljana  
Slovenia  
Tel.:00386 1 429 23 32  
Fax:00386 1 429 23 33

**USA**  
Hansgrohe  
1490 Bluegrass Lakes Parkway  
Alpharetta, GA 30004/USA  
Tel.: 770-360-9880  
Fax: 770-360-9887

**B** **L**  
Hansgrohe  
Rue Vanderschrick Straat 91  
1060 Bruxelles/Brussel  
Téléphone: 02 / 5 43 01 40  
Telefax: 02 / 5 37 94 86

**DK** **N**  
Hansgrohe  
Jegstrupvej 6  
8361 Hasselager  
Telefon: 86 28 74 00  
Telefax: 86 28 74 01

**FIN**  
Hansgrohe  
Juhani Niemi Oy  
Mäntytie 11  
00270 Helsinki  
Puh: (09) 47 77 030  
Telefax: (09) 24 17 554

**I**  
Pharo Italia  
Glass Idromassaggio s.r.l  
Via Baite 12/E  
31046 Oderzo (TV)  
Telefono: +39-0422-7146  
Telefax: +39-0422-816839

**P**  
HGAXorPharo SA  
R. Antoine de Saint-Exupéry  
Alapraia  
2765-043 Estoril  
Telefhone: 21 466 71 10  
Fax: 21 466 71 19

**RUS**  
Hansgrohe  
Усачева 33/1  
119048 Россия Москва  
Tel.: 095 / 9333170  
Fax: 095 / 9333171

**TR**  
Dizayn Ev Gerecleri  
San. ve Tic. Ltd. Sti.  
Ortaklar Cad. No. 1  
Mecidiyekoye-Istanbul 80290  
Tel.: 0090-212-266 50 80  
Fax: 0090-212-275 75 12

**CH**  
Hansgrohe  
Industriestr. 9  
5432 Neuenhof  
Telefon: 056/416 26 26  
Telefax: 056/416 26 27

**E**  
Hansgrohe  
Riera Can Pahissa 26 B  
08750 Molins de Rei  
Telefon: 93 680 39 00  
Telefax: 93 680 39 09

**GR**  
Nikitas Vlachos  
Niveco SA  
Posidonus Ave 46  
17561 P. Faliro  
Telefon: (01) 9880180  
Telefax: (01) 9883847

**IND**  
Jaquar Mercantile  
D-26, SMA Co-operative Industrial Estate  
G.T. Karnal Road  
Delhi-110033  
Tel : +91-11-27464808-17  
Fax:+91-11-27240388, 27466808

**PL**  
Hansgrohe  
Ul. Sowia 12  
PL-62-080 Tarnowa Podgórne  
Telefon: (061) 8168600  
Telefax: (061) 8168609

**S**  
Hansgrohe  
Almviksvägen 41  
23044 Bunkeflostrand  
Telefon: +46/(0)40/51 91 50  
Telefon: +46/(0)40/13 05 92

**UA**  
Hansgrohe  
Ukrainian office  
Vasilkovskaya St., 1, office 301  
03040 Kiev  
Ukraine  
Tel./Fax: 0038 (044) 56 85 012

**CZ** **SK**  
Hansgrohe  
Moravanská 85  
CZ-619 00 Brno  
Telefon: +420/547 212 334  
Telefax: +420/547 212 521

**EE**  
OÜ Dreesis  
Laki 16-407  
10621 Tallinn  
Estonia  
Tel.: 00372 61 29 811  
Fax: 00372 65 63 310

**H**  
Hansgrohe Kft.  
Forgách utca 11-13  
1139 Budapest  
Telefon: 0036 /1 236 9090  
Telefax: 0036 /1 236 9098

**LT**  
Santoza  
Pašilaičių 1-28  
LT-06115 Vilnius  
Tel.: +37(0) 5 2407666  
Fax: +37(0) 5 2407666

**PRC**  
上海市松江工业区俞塘路512号  
天威工业城底层  
邮编: 201600  
电话: 0086-21-57741239  
传真: 0086-21-57741233

**SGP**  
Hans Grohe Pte Ltd  
60B Martin Road  
#11-03/04 Trade Mart Singapore  
SINGAPORE 239067  
Tel.: 0065-7322002  
Fax: 0065-7320030

**UK**  
Hansgrohe  
Units D1 & D2 Sandown Park  
Trading Estate Royal Mills  
Esher Surrey KT10 8BL  
Telephone: 0 13 72 46 56 55  
Telefax: 0 13 72 47 06 70

**hansgrohe**

**AXOR | PHARO**

Hansgrohe · Postfach 1145 · D-77761 Schiltach · Telefon +49 (0) 78 36/51-1282 · Telefax +49 (0) 7836/511440  
E-Mail: info@hansgrohe.com · Internet: www.hansgrohe.com