

hansgrohe

取扱説明書 / 施工説明書

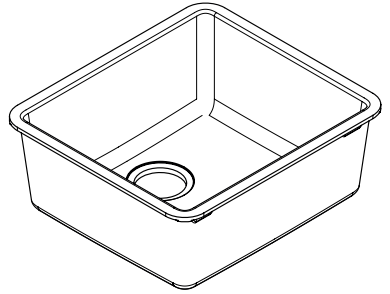

S510-U450 43431XXX

S510-U660 43432XXX

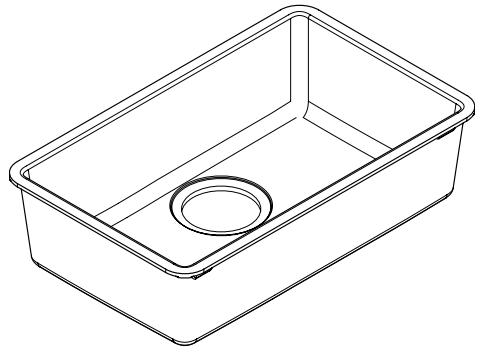

S520-U720 43452XXX



⚠ 安全上の注意

△ 施工の際は挟まれたり切り傷を負わないように手袋をはめてください。

施工上の注意

- ・ 施工前に製品に損傷等がないことを確認してください。施工後の損傷等のクレームのお申し出は受付いたしかねます。

使用上の注意

- ・ 本製品は結露が発生しにくい材質ですが、室内およびキャビネット内の温度・湿度環境によって、結露が発生する場合がございます。予めご了承ください。

施工と取扱いに関して



酢酸系シリコンをご使用にならないでください！



寸法 (解説ページ 3)



お手入れ方法 (解説ページ 8)

アンダーカウンター施工の場合
解説ページ 5

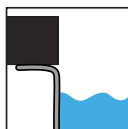

オーバーカウンター施工
解説ページ 6

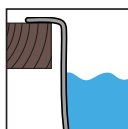

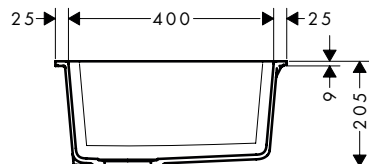
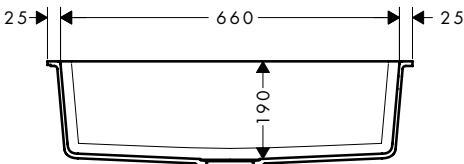
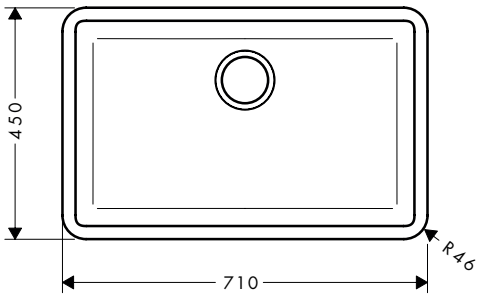
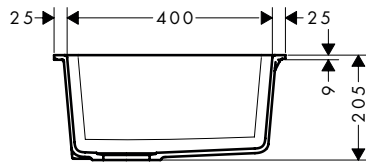
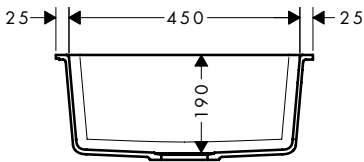
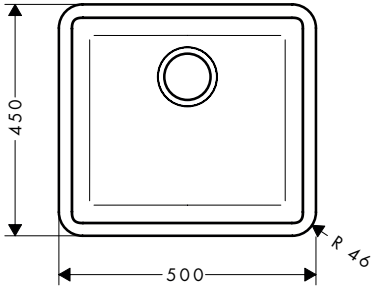

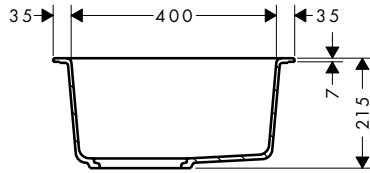
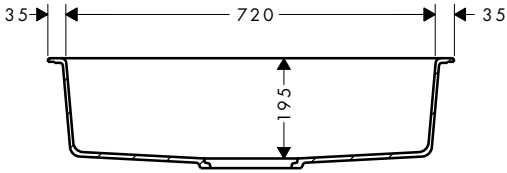
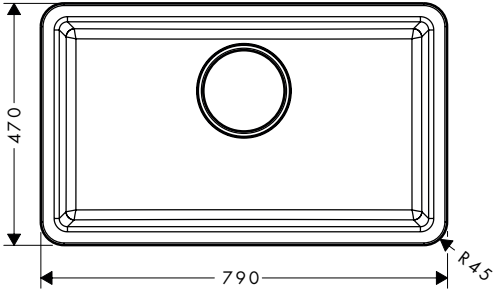

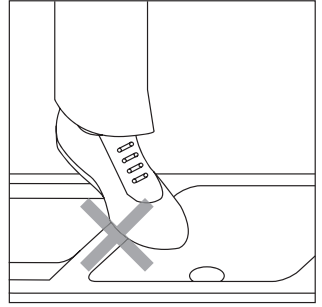
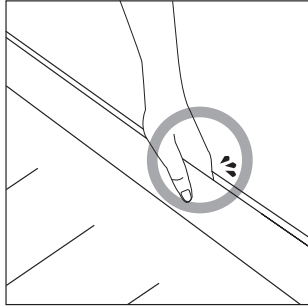
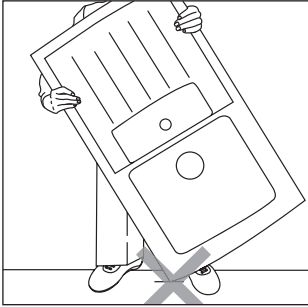

取扱いに注意してください

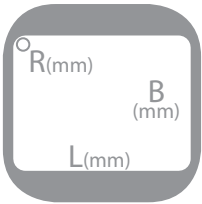

開口寸法

		L	B	R
43431XXX		448	398	16
43432XXX		658	398	16
43452XXX		740	420	10

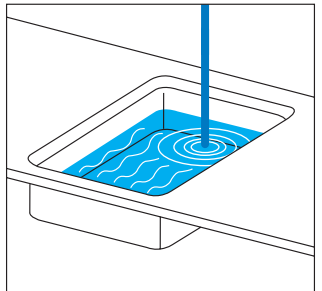
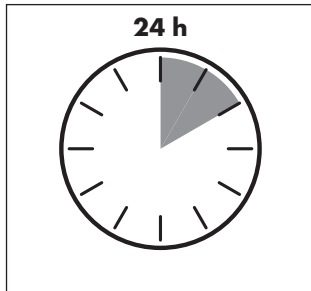
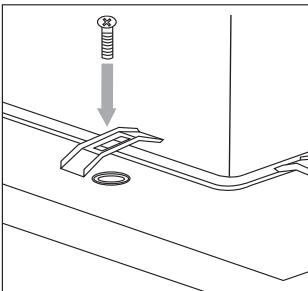
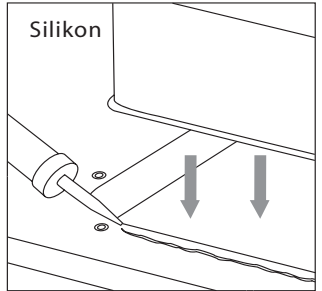
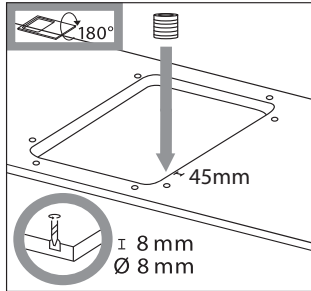
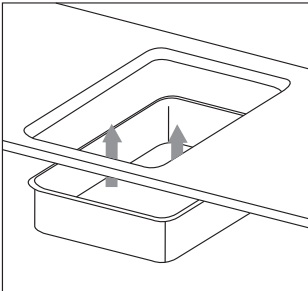

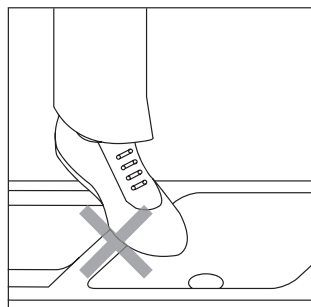
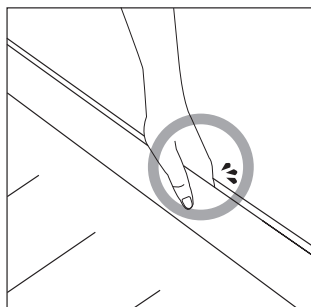
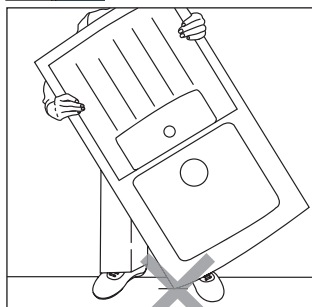
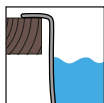

取扱いに注意してください

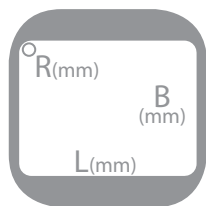

開口寸法

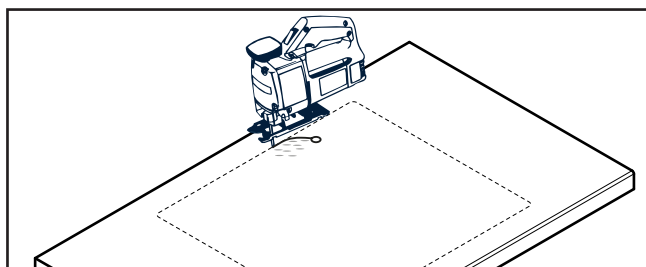

		L	B	R
43452XXX		770	450	35

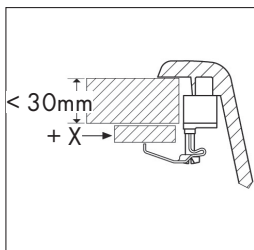
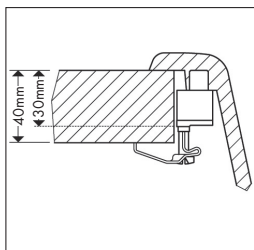

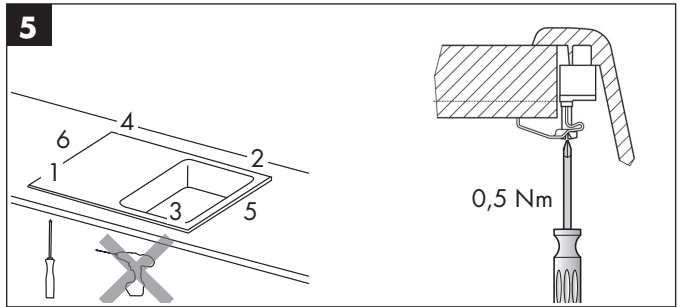
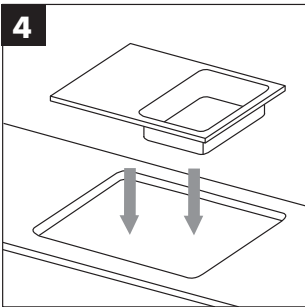
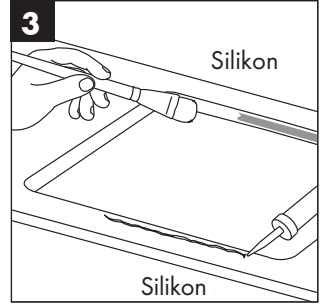
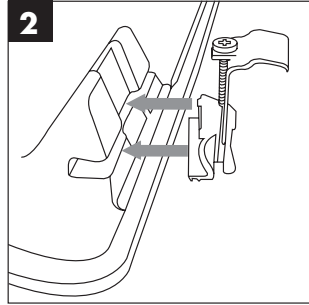
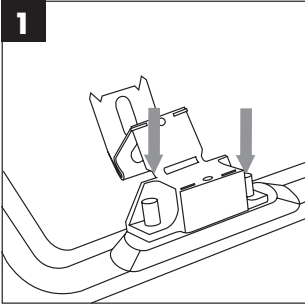



注意事項

磨き粉や研磨剤（クレンザー）、および苛性ソーダ（水酸化ナトリウム）、ギ酸、強力な酸性類の洗剤は使用できません。



クレンザーなどの磨き粉や研磨剤



鋭利なものをぶつけたりしない



熱い鍋やフライパンを直接置かない

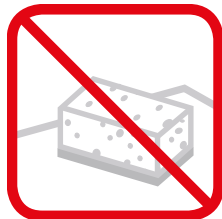

ナイロンたわし（ハードスポンジ）を使用しない

グラナイトシンクのクリーニングとお手入れ方法



表面保護材（非浸透性の石材用保護剤、食品衛生法に適合するものをご使用ください！）



水あか用洗剤



クリーニングクロス

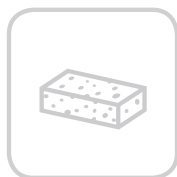

メラミンスポンジ（大きな傷の補修に使用します。細かい傷がつきません）



台所用中性洗剤

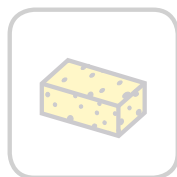

食器洗い用スポンジ

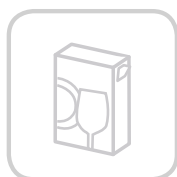

食器洗い機用粉せっけん



<通常のお手入れ>
少量の台所用洗剤を
洗浄スポンジに含ませ、お掃除してください。

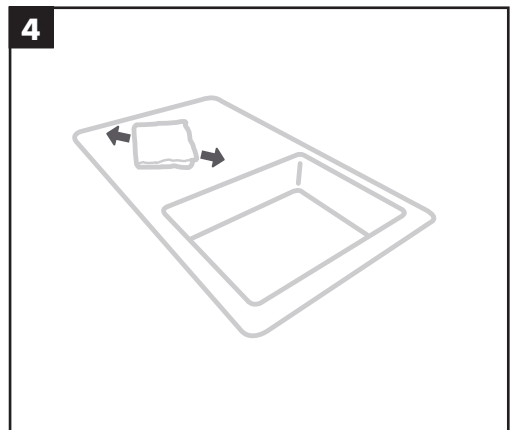
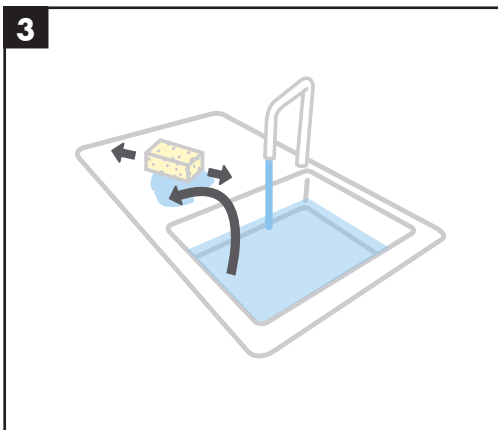
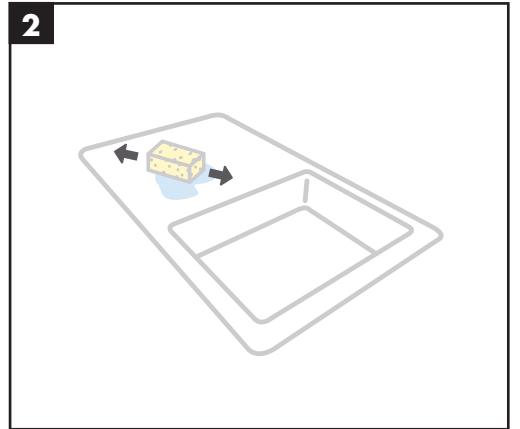
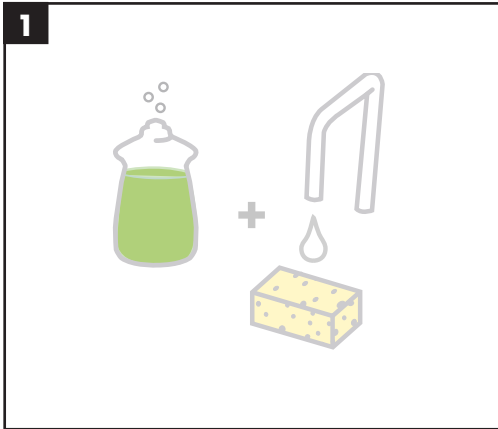



くしつこい汚れを落とす場合>
ひどい油汚れ、放置した汚れなど通常のお掃除で落とせない場合は、時間をかけてお掃除してください。

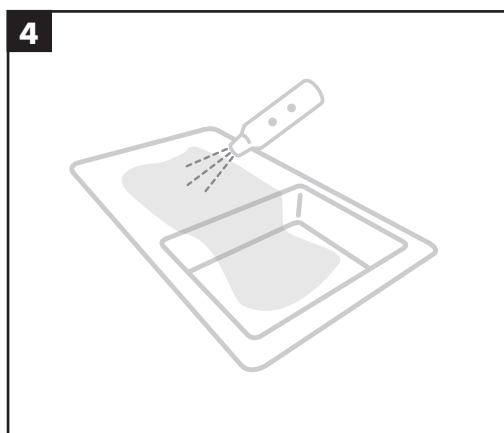
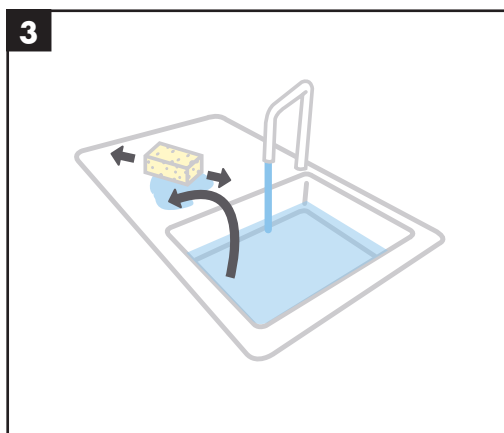
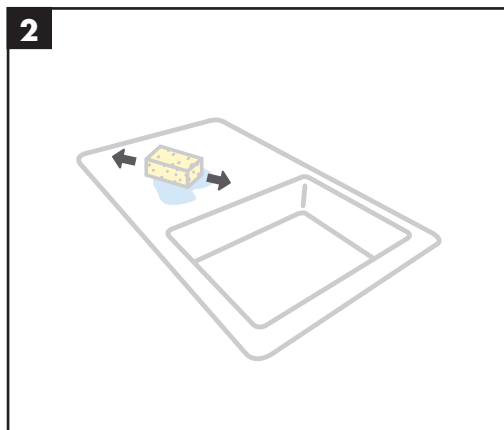
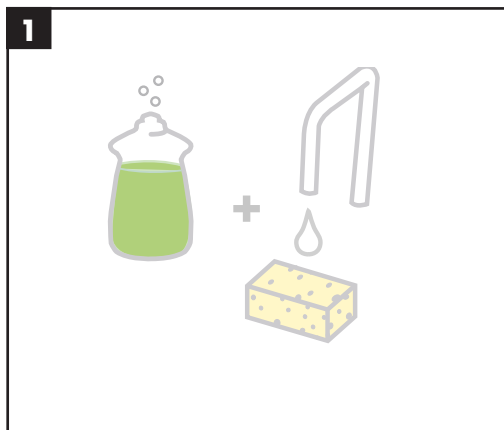



5



00:10:00

10分間放置します

6

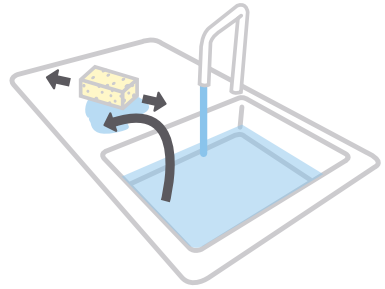

7

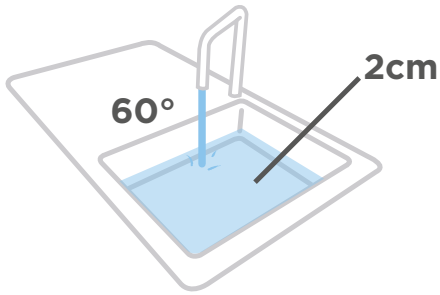

8



9



01:30:00

1時間30分放置します。

10

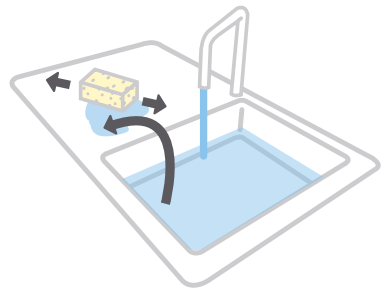



11

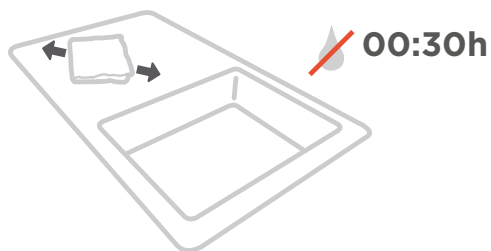

乾拭き後、30分間乾燥させてください

12

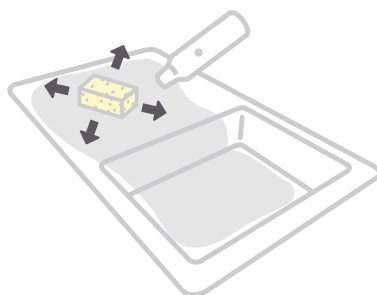

13



00:01:00

1分間放置します

14

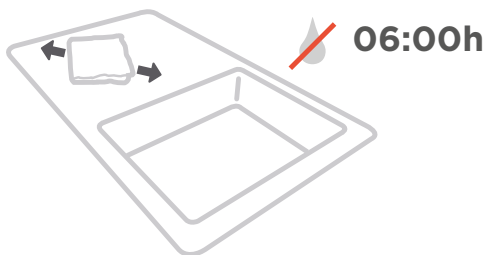

乾拭き後、6時間乾燥させてください



<水垢汚れの場合>
水垢除去用洗剤を使用
して除去してください

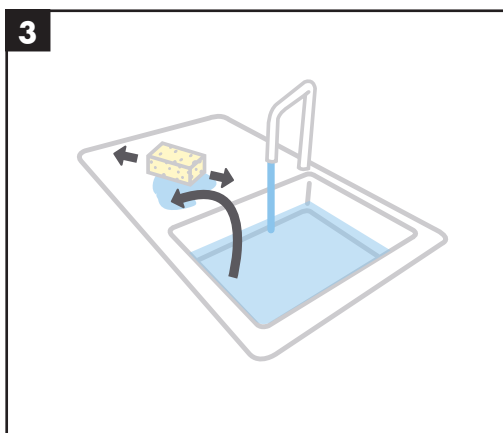
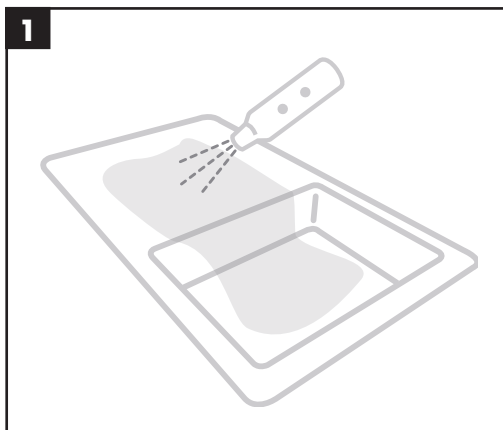



<鍋底などで付いた
キズ>
メラミンスポンジに
水を含ませ、キズの
箇所を擦ったのち、
洗浄用スポンジにて
水洗いします

