

ZH 用户手册 / 组装说明 **2**

EN Instructions for use / Assembly instructions **20**

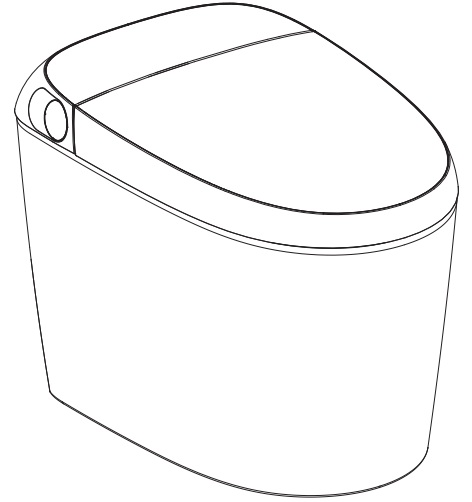

纯境 Original S LavaPura Original S

LavaPura Original S FS eToilet B plus 305mm
纯境Original S 轻智能落地坐便器舒适版Plus 305mm
22486007

LavaPura Original S FS eToilet B plus 400mm
纯境Original S 轻智能落地坐便器舒适版Plus 400mm
22487007

目录

安 装

安全注意事项	3
所需工具及材料	5
尺寸图	5
技术规格	6
整体简图	7
产品清单	8
安装坐便器	9
安装墙贴按键	10

使 用 说 明

使用前准备	11
关盖冲水功能	12
墙贴按键使用说明	12
本体按键功能	13

日 常 保 养

本体的保养	14
停电停水时	14
长时间不使用时	15

其 他

常见故障诊断和排除	16
电器电子产品中有害物质信息表	17
能效水效等级说明	17
关于微功率短距离无线电发射设备	18
产品保修卡	19

安全注意事项



安装前请务必仔细阅读此说明书，并严格按照说明书规定进行安装，阅读后，请将此说明书放在醒目的地方妥善保存。

为了避免使用者和他人受到伤害和财产损失，请严格遵守安全警告和注意事项。



标志及其含义

警告	表示如果不遵守此警告中的规定而误操作时，有可能造成人员重伤或死亡。
注意	表示如果不遵守此注意中的规定而误操作时，有可能造成人身伤害或财产损失。

下列标志是为了表示使用产品时重要安全注意事项而使用的。

标志	说明
	此图表示不可行，【禁止】之意。
	此图表示必须【强制】实行的内容。

警告

	<ul style="list-style-type: none">· 本产品属于固定式器具，应由专业人士进行安装、固定于特定位置使用。· 本产品供水水压范围必须为0.02MPa（动压）--0.8MPa（静压）。· 安装应使用随器具附带的新软管组件及其它附带或指定的零部件，旧软管组件不能重复利用，否则可能引起漏水、火灾或触电。· 器具只能与随机配送的停电冲刷电池模块一同使用。· 如果电源软线损坏,为了避免危险,必须由制造商、其服务机构或类似的专业人员更换。
	<ul style="list-style-type: none">· 使用者不应自行拆卸家用电器，不应变更内部接线、部件和保护装置，否则可能会引起火灾或触电。· 点燃的香烟及其它燃烧物不能投入坐便盖内，否则可能会引起火灾。· 严禁将水或洗涤剂浇于机身或电源插头上，否则可能会引起火灾或触电。· 严禁用湿手触摸电源插头，否则可能会引起触电。· 严禁在同一插座上使用其他电器，严禁从带插座的灯头上引接电源供给电器，否则可能会引起火灾或触电。· 严禁使用电源延长线或松脱不稳的电源插座，否则可能会引起火灾或触电。· 本产品属电器类产品，禁止置于易被水淋到的地方，请勿将尿液或其它液体淋到本体上。· 产品通电时，不得将产品侧放或倒置，否则可能会引起火灾或烧毁。· 请勿在湿度超过90%RH的房间安装使用本产品，使用环境需干湿分离，如安装淋浴房或浴帘。· 使用者不应以普通导体或超出规定电流容量的熔断体替换家用电器和电源的熔断体。· 使用者不应自行改变低压断路器或剩余电流动作保护器的设定值。

警告



- 请确保产品使用的电源插座接线符合国家标准(左零右火), 不能接反。
- 插座位置需安装在不易被水淋到的地方, 建议使用防水型插座。
- 使用过程中, 请将电源插头完全插入电源插座中, 并保持电源插头与插座接触良好, 否则可能引起触电或火灾。
- 从插座上拔电源插头时, 须手持插头本体, 不应在电源线施加拉力。
- 当产品由寒冷或潮湿的地方搬至室内时, 先放置2小时, 使机内凝水充分挥发, 再开机使用, 以免造成产品短路。
- 产品出现异常噪声、异常气味、异常高温或故障时, 请立即停止使用, 并拔下电源插头, 关闭供水阀门, 并及时与服务商联系。

注意



- 打雷时, 拔出电源插头。
- 请勿将产品放置在可能掉入或被拉入浴缸或水槽的位置。
- 请勿将产品放置在水或其他液体中。
- 请勿触及已经掉入水中或浸水的产品, 并立刻拔掉电源插头。
- 请勿站在坐便器上, 不要用重力撞击陶瓷, 以防止破损漏水。
- 禁止坐便器底座埋入胶凝材料(水泥砂浆), 否则可能因膨胀而撑裂陶瓷。
- 禁止施加强力或冲击, 不要站在座圈、便盖或本体上, 不要放置重物。
- 禁止使用香蕉水、汽油、药水及洗涤剂、杀虫剂、厕所清洁剂和硬毛刷清洁本产品。
- 请勿使用GB 5749标准自来水以外的水源, 否则可能会引起系统故障或皮肤发炎等问题。
- 请勿让阳光直接照射产品, 以免产品变色及影响遥控接收效果。
- 本产品座圈和便盖有缓降功能, 请勿用力按压, 以免损坏缓降器。
- 请勿将进水管与热水器出水管连接, 进水温度3-35°C, 超过规定范围将可能导致内置加热组件不工作或产品损坏。
- 使用产品时, 请勿向后靠在便盖上, 以免损坏产品。
- 请不要向坐便器内冲入新闻纸、纸尿垫、妇用卫生巾等容易堵塞的物品。



- 进行安装、拆卸、维修及保养产品时, 必须拔下电源插头, 关闭供水阀门。
- 不要在0°C以下环境中使用, 如果室温低于0°C, 必须将水箱内水排空, 防止水箱冻裂。预防因冻结而造成的损坏, 请实施保暖措施, 提高厕所温度。
- 如果长期不使用, 必须切断电源, 并将水箱内的水排空。
- 本产品不打算由存在肢体、感官或精神能力缺陷或缺乏使用经验和知识的人(包括儿童)使用, 除非有负责他们安全的人对他们进行与产品使用有关的监督或指导, 心脏病患者请谨慎使用。
- 应照看好儿童, 确保他们不玩耍本产品。
- 使用前请放水清洗进水管, 避免进水管阻塞。
- 本产品需连接到排污水管道系统使用。

所需工具及材料(不随货供应)

- 活络扳手×2



- 卷尺



- 生料带



- 美工刀



- 冲击钻



- 各种螺丝刀

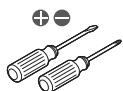

- 玻璃胶枪

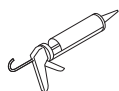

- 玻璃胶



- 记号笔



- 水平仪

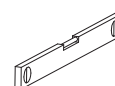

尺寸图

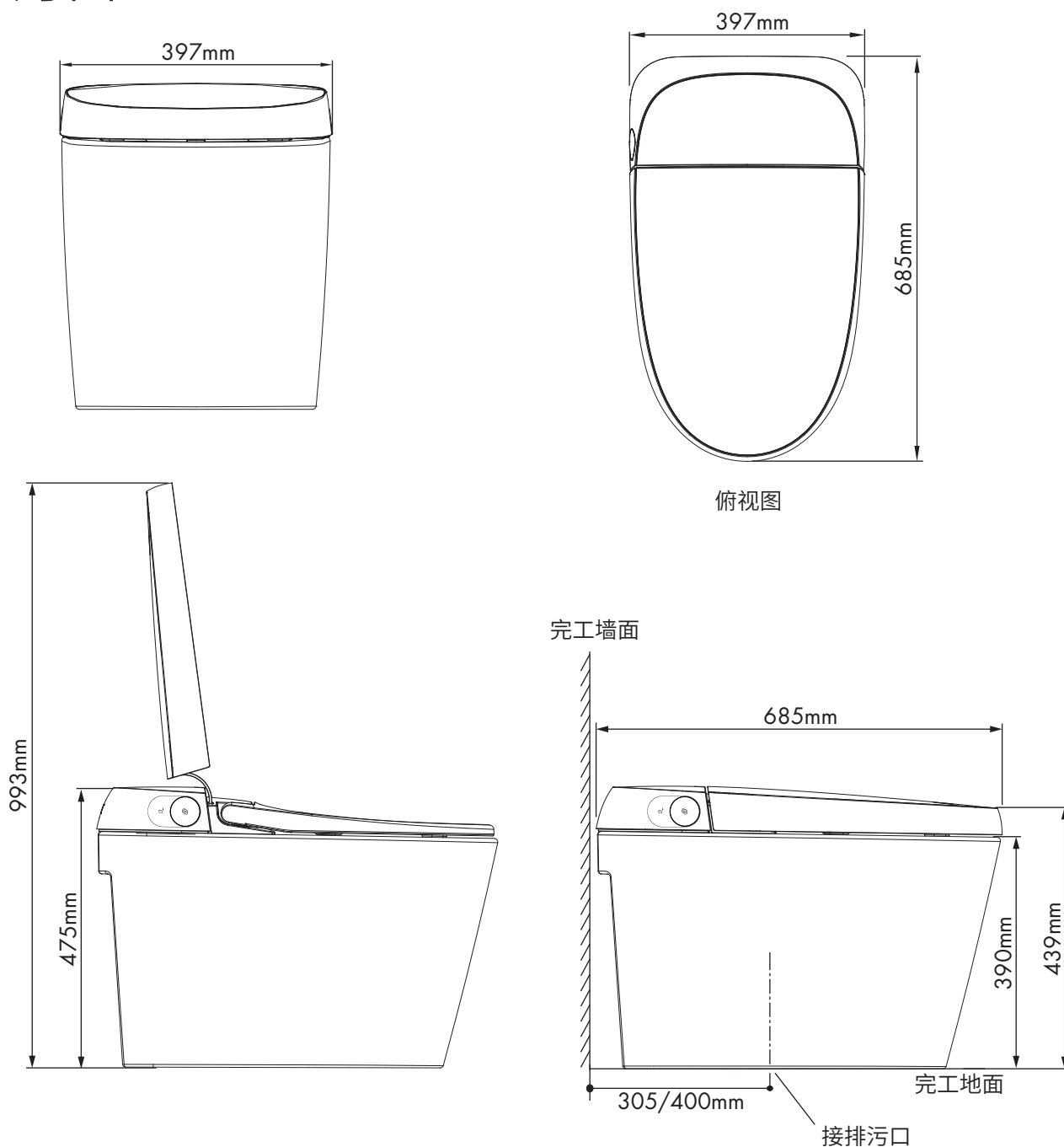

备注: 1.本说明书产品外形图仅供参考,我们保留对产品外形修改的权利。
2.产品外观如有改动,以实物为准。

技术规格

项目		22486007	22487007
坑距		305mm	400mm
额定电源		交流220V 50Hz	
*额定功率		110W	
进水软管长度		约650mm	
电源线长度		约1.4m	
防水保护等级		IPX4	
坐便器	**平均用水量	3.8L (大冲4.8L/小冲3.3L)	
	水效等级	1级	
	进水方式	直接连接自来水	
	冲洗方式	喷射虹吸式	
	排污口外径	80~95mm	
	排水方式	下排水	
功能部	加热座圈	表面温度	温度调节范围: 关/约31--39°C
		加热器功率	50W
		防低温烫伤	使用10分钟后, 座温自动缓慢降低到低档 (约31°C)
		安全装置	落座感应器、温度传感器、温度保险丝、温控器、漏电保护插头
贴心设置	自动冲水功能	离座后自动冲水	
	关盖冲水功能	关闭便盖进行冲水	
	断电冲水功能	手动关盖冲水 (需连接电池盒使用, 电池盒内电池需要另行购买)	
进水压力		0.02MPa(动压) -- 0.8MPa(静压)	
进水温度		3°C--35°C	
环境温度		1°C--40°C	
***抑菌部位		座圈、陶瓷釉面	
产品尺寸		长685mm×宽397mm×高475mm	
产品重量		38kg	
产品执行标准		GB/T 4706.1-2024 / GB/T 4706.53-2024	

说明:

*额定功率: 本产品环境温度23°C, 进水静压0.18MPa±0.02MPa下, 开始上电开机, 将座温设置为最高档, 立即开启马桶冲水功能, 并持续稳定工作一个冲水周期的平均功率。

**平均用水量: 本产品平均用水量3.8L (大冲4.8L/小冲3.3L) 不含预湿润用水量。

***座圈: 依据ISO 22196-2011 标准中的抗菌性能要求, 有效抵抗大肠杆菌/金黄色葡萄球菌的滋生。

陶瓷: 依据《JC/T 897-2014 抗菌陶瓷制品抗菌性能》标准中的抗菌性能要求, 有效抵抗大肠杆菌、金黄色葡萄球菌滋生。

整体简图

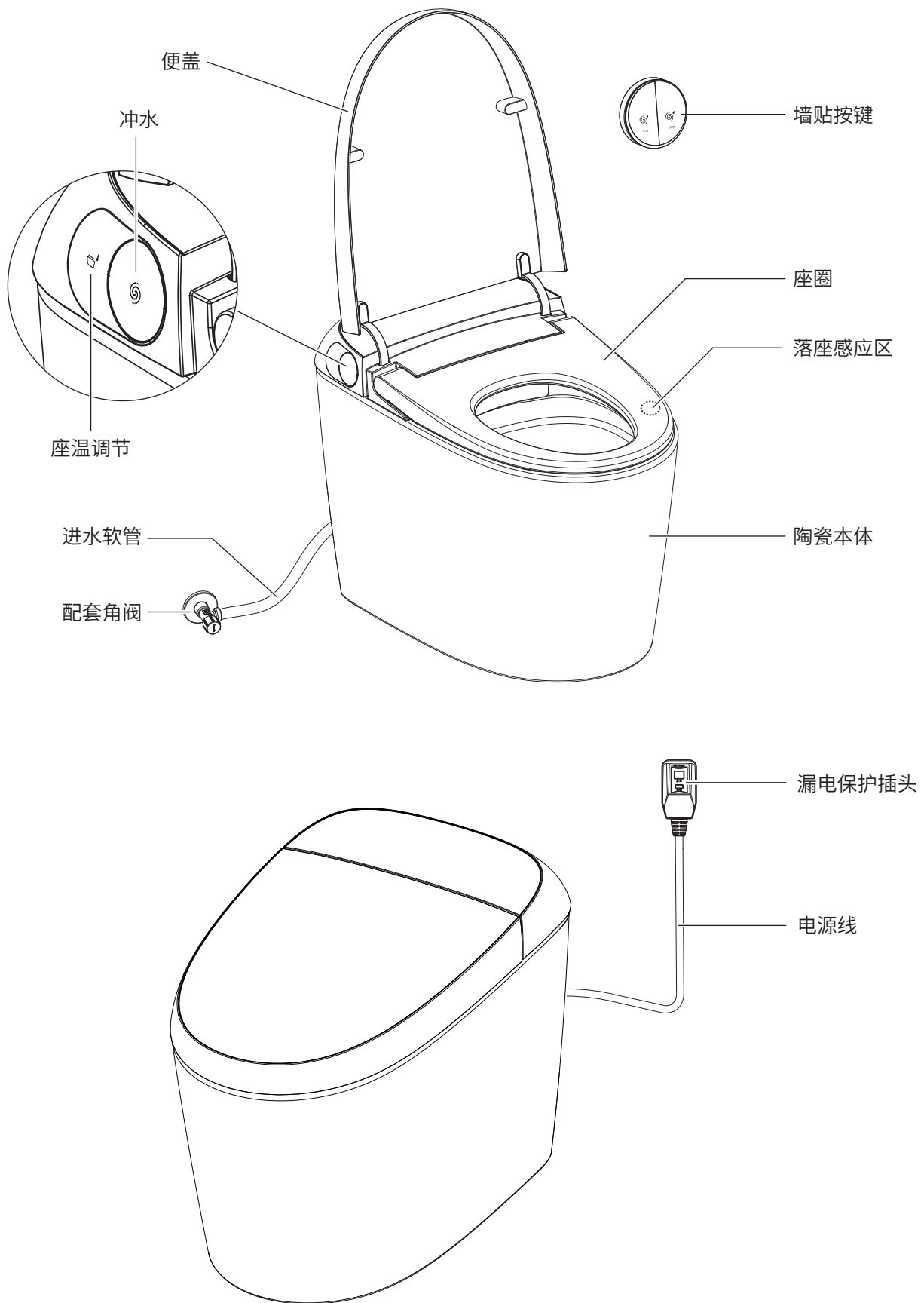

产品清单

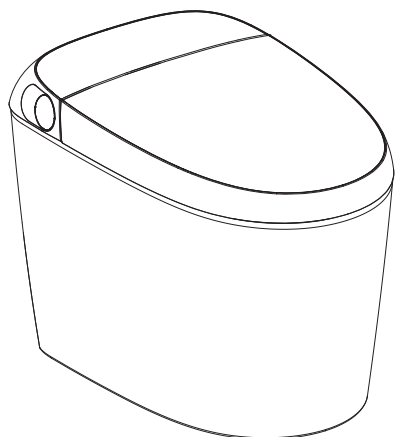

轻智能一体坐便器



密封法兰



配套角阀



对孔纸板



说明书



保修卡（附于说明书内）



合格证

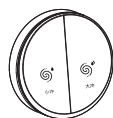

墙贴按键

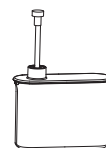

停电冲水电池盒

安装坐便器

1. 安装配套角阀

- 提示：1.若墙面已安装旧角阀，需由专业人员进行更换，避免因拆卸不当导致角阀无法安装。
2.必须使用配套角阀，否则可能造成管路堵塞。

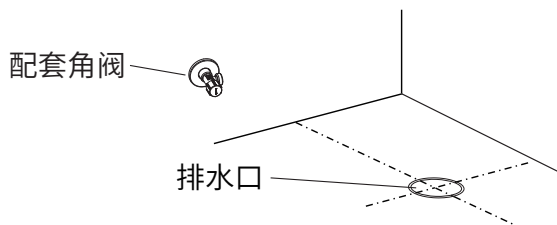

2. 对孔纸板安装说明

- 用地平仪测量地面，确保安装面积地面平整；
将对孔纸板对齐排污口中心线，根据对孔纸板描绘出相应的轮廓线后移除纸板。

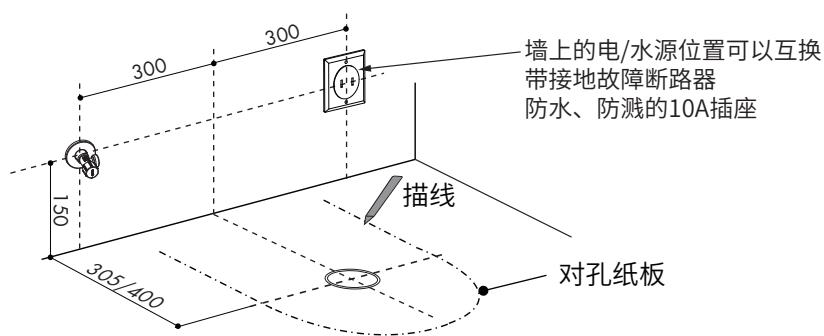

3. 安装坐便器

- 将密封法兰套入坐便器排污口；
根据描绘出的轮廓线将坐便器装入相应位置。

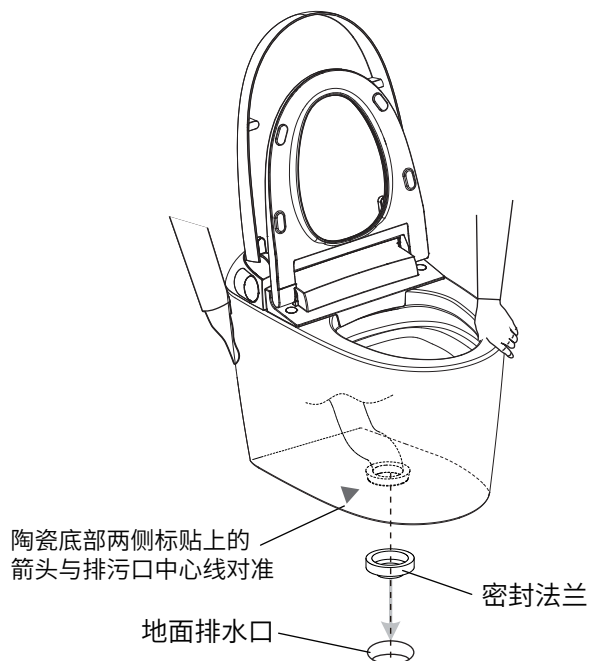

- 温馨提示：由于一体机比较重，需翻开座圈，由两人配合抬起；
严禁从盖板部分搬运产品（容易引起机械故障）。

4. 安装进水软管

用配套进水软管将坐便器的进水口和角阀连接起来，并旋紧。

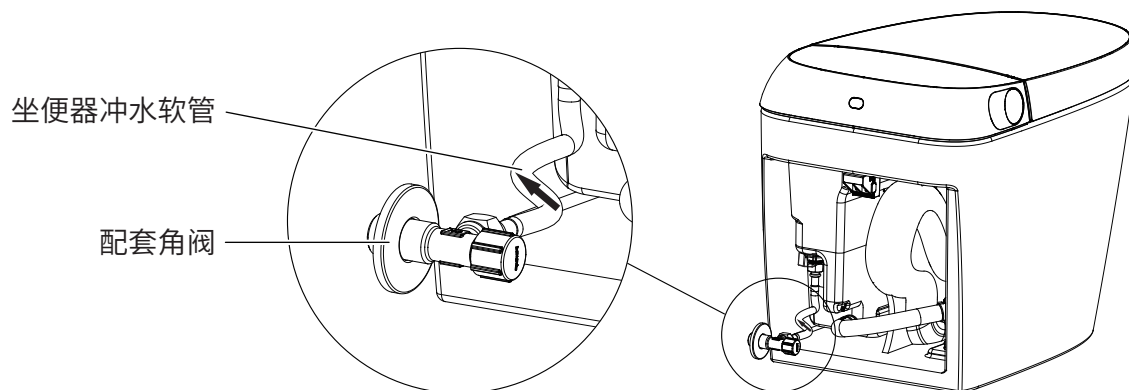

5. 涂玻璃胶

在便器下边缘周围涂上优质防霉玻璃胶。

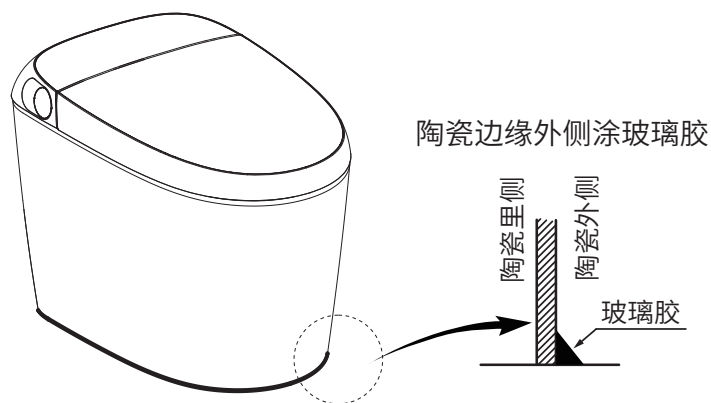

温馨提示：请将排污口的垃圾和其他污物清理干净；
安装坐便器时，请确保坐便器排污口与地面排水口安装到位。

安装墙贴按键

清洁并擦干墙上预留的墙贴按键安装位置。
将墙贴按键底部的双面胶贴纸撕下，贴紧墙壁。



温馨提示：墙贴按键属于自发电开关，按压发电，无需电池。

使用前准备

1. 打开角阀

查看螺纹连接处密封性，确定不漏水，逆时针旋开角阀，开口调至最大。
(温馨提示：初次开启时，角阀把手扭力较大)

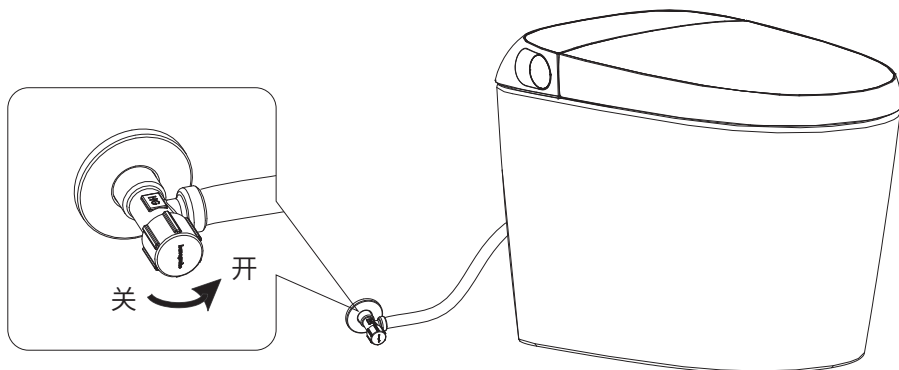

2. 接通电源

电源线漏电保护插头插入电源插座，按下复位键，电源指示灯亮，表示通电。

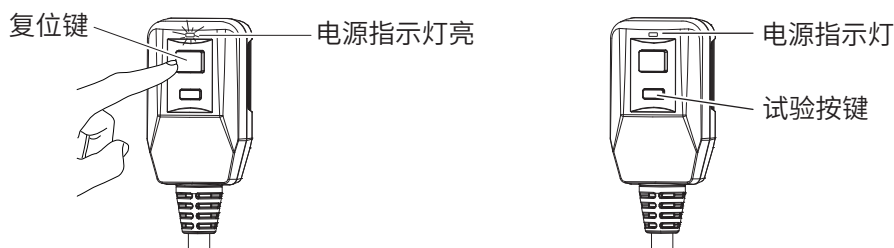

温馨提示：使用前先按下漏电试验按键，复位键弹起，指示灯熄灭，表示漏电保护功能正常。

3. 安全自检



- ① 上电后，主机蜂鸣器一声“嘀”，开始自检；
- ② 约10秒后，主机蜂鸣器响再一声“嘀”，自检完毕；
- ③ 功能模式开启，正常使用。

关盖冲水功能

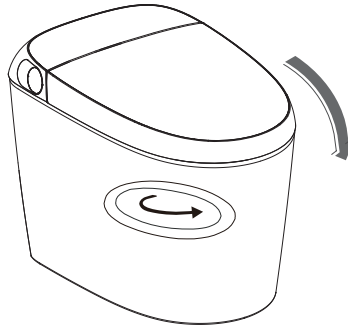
本产品能实现关盖冲水功能，功能开启时：
手动关闭便盖，即可进行大冲水。



墙贴按键使用说明

1. 短按“”键，启动半冲功能，马桶开始小冲水。
2. 短按“”键，启动全冲功能，马桶开始大冲水。

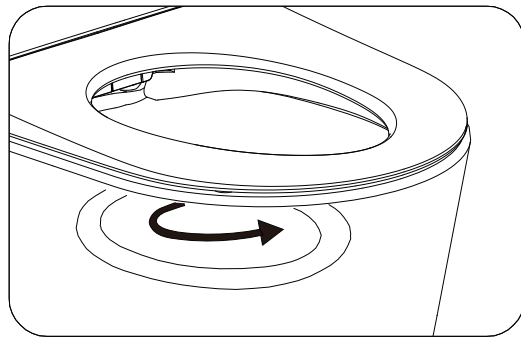
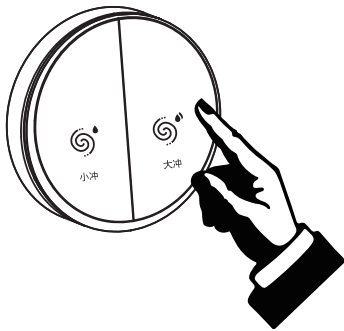

※若按压墙贴按键马桶无冲水动作，请进行与主机对码。

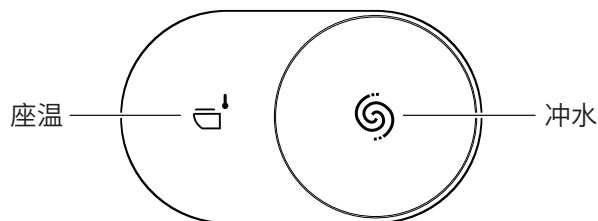

- ① 拔下电源插头，主机断电；
- ② 5秒后重新插上电源插头，并按下电源插头“复位”键，主机上电，待上电提示音“嘀”声完毕后，在10秒内按下墙贴按键任意一个键；
- ③ 对码成功，待主机完成自检后“嘀”一声即可使用墙贴按键。

本体按键功能



冲水功能



1. 短按“”键，启动全冲功能，马桶开始大冲水。
2. 上电自检完30秒后，长按“”键，设置开启或关闭关盖冲水功能。
(关盖冲水功能出厂默认开启)

自动冲水功能

本产品能实现离座自动冲水功能，

- 离座后会自动进行大/小冲水。
(落座时间6秒~30秒: 小冲水; 落座时间超过30秒: 大冲水; 落座时间若少于6秒: 不进行冲水。)
- 上电自检完30秒内长按“”键，设置开启或关闭自动冲水功能。
(自动冲水功能出厂默认开启)

座温调节



短按“”键调节座温，档位调节方式为0-3档依次循环，座温第1档时蜂鸣器短鸣一声，座温第2档时蜂鸣器短鸣两声，座温第3档时蜂鸣器短鸣三声，座温0档（常温档）时蜂鸣器长鸣一声。

预湿润

同时按住“”键及“”键3秒以上，开启或关闭预湿润功能。

开启时，当检测到用户落座时，便器会自动冲出少量水湿润陶瓷内壁，使污物不易附着。
(预湿润出厂默认开启)

节能模式

当24小时无操作时，自动进入节能模式；在节能模式下，座温处于低温状态（第1档温度）以达到节能的目的。(注：节能前座温若为常温档，节能后保持常温档)。

当48小时无操作时，自动进入待机模式；在待机模式下，座圈加热关闭。

当有人使用时，自动恢复功能模式。

本体的保养

- 1.切断电源：本体保养时请先切断电源。
- 2.柔软抹布擦拭：请用拧干水分的柔软抹布擦拭脏污部位。
- 3.安全自检：擦拭完成后请重新接上电源。
- 4.使用过程中若发现坐便器有移动或晃动，请检查硅胶是否老化松动，如果松动需要铲除重新涂抹。



停电停水时

停电时冲洗坐便器的方法:

1. 电池装入停电冲水电池盒

- ① 将电池盒上盖与电池盒下盖分离；装入10节5号(AA型)电池，更换时请注意正、负极需一一对应；
- ② 装入电池后，将电池盒上盖与电池盒下盖重新扣紧。

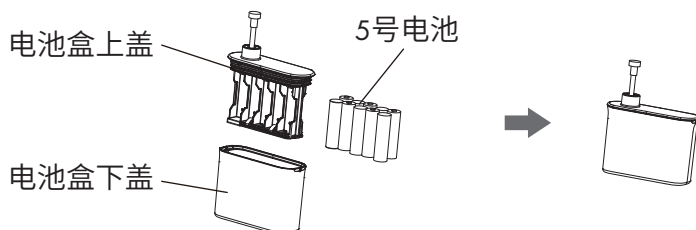

温馨提示:

- ① 电池盒为停电冲水的外接电源，建议停电时再连接至主机使用。
- ② 本产品不可充电，供电端子不可短接，以免造成危险。
- ③ 更换电池前，需先将电池盒与主机相连的连接线对插端子分离，之后拆开电池盒盖，取出旧电池。
- ④ 建议使用南孚5号电池，新旧电池不可混用，不同型号、不同品牌电池不可混用。
- ⑤ 严格按照电池仓内的“+”和“-”标志装入电池，本产品为串联电池组，单体不能接反，否则将造成电池损坏，严重时电池有爆裂隐患。
- ⑥ 电池用尽应取出，并进行安全处置，切勿随意丢弃。
- ⑦ 不可拆装电池以外的零件，否则可能导致电池盒密封失效，卫生间潮气进入盒内，将导致电池锈蚀损坏。
- ⑧ 长期未使用，请将盒内的电池取出并妥善保管。
- ⑨ 为避免漏液，建议电池每隔2年更换1次。
- ⑩ 更换1次新电池后，预计可进行35次停电冲水功能。（此为理论次数，请以实际使用为准）。

2. 连接停电冲水电池盒

- ① 取出陶瓷后面本体端的电池连接线公端（红色），拧去端子盖；
- ② 将本体端的电池连接线（公端）与停电冲水电池盒连接线（母端）对接，并拧紧。

温馨提示:

电池连接公端、母端有正负极之分，两个端子内有定位结构，请勿强行对插，否则可能导致其损坏。

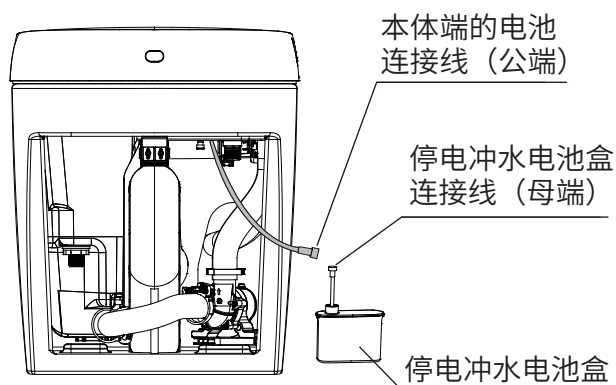

3.停电冲水功能

手动关闭便盖，即可进行冲水。

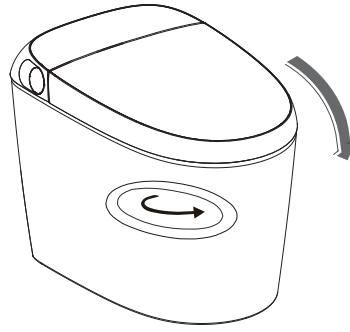

4.取下停电冲水电池盒

恢复供电后，请务必取下停电冲水电池盒，并拧回本体端的电池连接线公端（红色）端子盖。

停水时冲洗坐便器的方法:

将水放入较大的水桶（约8L）内，以坐便器槽面为中心进行冲洗。此时，注意防止水从坐便器溢出。

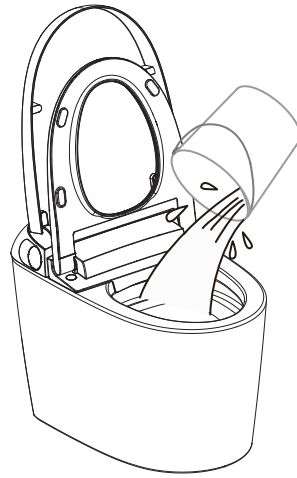

长时间不使用时

尤其是冬季，长期不在家时，请务必将水箱及管路中的水排空，防止冻结。

排水的方法:

- 1.将马桶水箱中的水排空：关闭进水角阀，启动一次冲水。
- 2.拔出电源插头，切断电源。
- 3.将管路中的水排空：将软管从角阀上旋开，排空管路的水后重新装回。



4.处理坐便器内积水:

为了安全起见，建议将防冻液放入便器内的积水中。

温馨提示：在排水前，必须切断电源！再次使用坐便器时，请务必再次通水、通电。

常见故障诊断和排除

现象	原因	处理
完全不工作	是否停电或总开关、电源插头跳闸	恢复供电后再次检查电源
	电源插头是否插好	应完全插入电源插座，重新插入时，请间隔10秒左右
	是否漏电？电源插头的指示灯是否熄灭	将电源插头从插座拔出，再次插入，按下电源插头的复位按键。如此操作仍不能工作时，请拔出电源插头，委托修理
	处于待机模式	请落座进入工作模式
无法自动冲水	请确认是否停水	等待供水恢复
	处于待机模式	请落座进入工作模式
座温不热	座温设定常温档	重新设定座温档位
	处于待机或节能模式	切换到功能模式3分钟后使用
 注意	如果按上述方法处理后故障仍未排除，应切断电源，联系服务商，请专业人员维修	
	如果电源漏电保护开关时常跳开，表示产品有漏电，请切断电源，联系服务商，请专业人员维修	

电器电子产品中有害物质信息表

部件名称	有害物质									
	铅 Pb	汞 Hg	镉 Cd	六价铬 Cr(VI)	多溴联苯 PBBs	多溴二苯醚 PBDEs	邻苯二甲酸二异丁酯 DIBP	邻苯二甲酸二正丁酯 DBP	邻苯二甲酸丁苄酯 BBP	邻苯二甲酸二己酯 DEHP
电源线	×	○	○	○	○	○	○	○	○	○
电路板	×	○	○	○	○	○	○	○	○	○
着座传感器	×	○	○	○	○	○	○	○	○	○
温度传感器	×	○	○	○	○	○	○	○	○	○
进水软管	×	○	○	○	○	○	○	○	○	○
膨胀螺栓	×	○	○	○	○	○	○	○	○	○
温度保护器	○	○	×	○	○	○	○	○	○	○
角阀	×	○	○	○	○	○	○	○	○	○

注1：○：表示该有害物质在该部件所有均质材料中的含量均不超出电器电子产品有害物质限制使用国家标准要求。
 ×：表示该有害物质至少在该部件的某一均质材料中的含量超出电器电子产品有害物质限制使用国家标准要求。
 注2：以上未列出的部件，表明其有害物质含量均不超出电器电子产品有害物质限制使用国家标准要求。

环境保护使用期限

此标志中的年数，是基于SJ/T 11364-2024【电器电子产品有害物质限制使用标识要求】的环境保护使用期限。

只要遵守使用说明书上记载的此产品安全与使用方面的注意事项，从制造日算起的此年限内，就不会发生由于使用产品引起有害物质的外泄或突变，不会对环境造成严重污染或对使用者人身及财产成严重损害。

【环境保护使用期限】不是安全使用期限亦不是品质保证期限，产品不适合继续使用需要废弃时，请遵守电子电气产品回收再利用相关的法律规定进行处理，感谢您的配合。

备注：根据产品的型号不同，您所购买的产品可能不会含有以上的所有部件。

能效水效等级说明

本产品符合GB 38448《智能坐便器能效水效限定值及等级》的要求，具体详见粘贴在产品上的水效标识。

关于微功率短距离无线电发射设备

1. 根据购买的产品不同，不同的产品可能会配置以下一种或多种的微功率短距离无线电发射设备，使用微功率短距离无线电发射设备应当符合国家无线电管理有关规定，本产品仅限在家庭卫生间使用。

①遥控器属于《微功率短距离无线电发射设备目录和技术要求》的“（一）通用微功率设备-6.F类设备”，天线类型为PCB（印刷电路板）板载天线，供电电压为2节或3节1.5V干电池；3.7V锂电池；3V纽扣电池，具体见电池安装使用说明。

（1）使用频率: 2400-2483.5 MHz。

（2）发射功率限值: 10 mW (e.i.r.p)。

（3）频率容限: 75 kHz。

②微波感应器属于《微功率短距离无线电发射设备目录和技术要求》的“（一）通用微功率设备-8.H类设备”，天线类型为PCB（印刷电路板）板载天线，供电电压为5V。

（1）使用频率: 24-24.25 GHz。

（2）发射功率限值: 20 mW (e.i.r.p)。

2. 不得擅自改变使用场景或使用条件、扩大发射频率范围、加大发射功率（包括额外加装射频功率放大器），不得擅自更改发射天线；

3. 不得对其他合法的无线电台（站）产生有害干扰，也不得提出免受有害干扰保护；

4. 本设备能承受辐射射频能量的工业、科学及医疗（ISM）应用设备的干扰或其他合法的无线电台（站）干扰；

5. 如对其他合法的无线电台（站）产生有害干扰时，应立即停止使用，并采取措施消除干扰后方可继续使用；

6. 在航空器内和依据法律法规、国家有关规定、标准划设的射电天文台、气象雷达站、卫星地球站（含测控、测距、接收、导航站）等军民用无线电台（站）、机场等的电磁环境保护区域内使用微功率设备，应当遵守电磁环境保护及相关行业主管部门的规定；

7. 禁止在以机场跑道中心点为圆心、半径5000米的区域内使用各类模型遥控器（本产品不涉及模型遥控器）；

8. 本设备使用环境温度范围为 0°C 至 40°C。

产品保修卡

产品型号		客户姓名	
销售单位		购买日期	
发票号码		客户电话	
经销商盖章		经销商电话	

感谢您购买本公司产品!为确保产品信誉及维护您的消费权益,自购买日起(以购买单据日期为准),本公司将为您提供免费的保修服务:电子部分三年,陶瓷部分五年,敬请放心使用。

按照说明书和使用注意事项正常使用后发生故障时,在保修期内免费维修。保修期内因故障要求维修时,可凭保修卡和原始发票与本公司联系,进行免费维修或更换(如果没有同样的型号则以类似型号代替,本公司保留此权利)。

如果超过保修期或遗失保修卡,本公司也提供维修服务并收取成本费用。

该有限责任仅适用于中国大陆(不包括香港、澳门、台湾)。

本公司产品的有限责任承担适合购买的本公司产品,保修期内以下情况下进行收费维修:

- 1.因使用不当,误操作或者不正当的修理改造而造成的损坏。
- 2.移动安装位置所造成的损坏。
- 3.由火灾、地震、水灾、雷击、冰冻及其他自然灾害,公害和气体灾害、硫酸、盐酸、异常电压引起的损坏。
- 4.因使用非指定电源(电压、频率)发生的损坏。
- 5.用于一般家庭或者酒店以外的用途,所发生的损坏。
- 6.因淤积的沙土、污物而产生的使用不良及包装等易耗品造成的损坏。



全国统一服务热线: 400-820-3555

为保障您的服务权益,请在安装后及时扫码注册

Contents

Installation

Safety Instructions	21
Tools and materials required	23
Dimensions	23
Technical Specifications	24
Sketch	25
List of Materials	26
Installation of the ceramic toilet	27
Wall-mounted Switch Installation Method	28

Instructions for Use

Preparation before Use	29
Close lid flush function	30
Wall-mounted Switch instructions	30
Functional Buttons of Main Unit	31

Routine Maintenance

Maintenance and Care of Main Unit	32
When the electricity and water supply is cut-off	32
When this product is left unused for a long time	33

Other

Fault Analysis and Solution	34
Information table of hazardous substances in electrical and electronic products	35
Grade of the energy efficiency and water efficiency	35
About Micro-Power Short-Range Radio Transmitter Equipment	36
Warranty Card	37

Safety Instructions



Please read this manual carefully before installation, and install this product in strict accordance with the manual. After reading, please keep this manual properly in a safe place.



To prevent users and others from injuries and property damages, please strictly observe the safety warnings and precautions.

Symbol Illustration

Warning	It indicates that serious injuries or deaths may be caused if you do not follow the instructions in this warning and operate this unit incorrectly.
Caution	It indicates that injuries or property losses may be caused if you do not follow the instructions in this caution and operate this unit incorrectly.

The following symbols are used to indicate important safety precautions when this product is used.

Symbol	Description
	This symbol indicates something to not do, meaning [prohibited].
	This symbol indicates something that must be performed [must do].

Warning	
	<ul style="list-style-type: none"> This product is a fixed appliance and should be installed and fixed in a specific location by professionals. The water supply pressure range of this product must be 0.02MPa (hydrodynamic pressure) -0.8MPa (hydrostatic pressure) . During installation, the new hose set and other attached or specified components that are supplied with the unit should be used, and the old hose set should not be reused. Otherwise, it may cause water leakage, fire or electric shock. The device can only be used with the power failure flushing battery module delivered with the device. If the power cord is damaged, it must be replaced by the manufacturer, their service organization, or similar professionals to avoid danger.
	<ul style="list-style-type: none"> Users should not disassemble household appliances by themselves and should not change internal wiring, components and protective devices, otherwise it may cause fire or electric shock. Do not put lit cigarettes and other burning materials into the toilet seat. Otherwise, it may cause a fire. Never pour water or detergent on the main unit or the power plug. Otherwise, it may cause a fire or an electric shock. Never touch the power plug with wet hands. Otherwise, it may cause electric shock. Never use other electrical appliances on the same socket with this product. It is strictly forbidden to connect power supply to electrical appliances from lamp holders with sockets. Otherwise, it may cause a fire or an electric shock. Never use an extension power cord or a loose and unstable power socket. Otherwise, it may cause a fire or an electric shock. This product is an electrical product. Never place it in a place where it is likely to be damped by water. When this product is energized, do not lay this product on its side or invert it. Otherwise, it may cause a fire or burns. Do not install or use this product in a bathroom or other damp places. Users should not replace fuses in household appliances and power supplies with ordinary conductors or fuses with current capacity exceeding the specified value. Users should not change the setting values of low voltage circuit breakers or residual current operated protectors on their own.

Warning



- Please ensure that the power socket wiring used for the product complies with national standards (left neutral wire and right live wire) and cannot be reversed.
- The socket should be located so that it is unlikely to be damped by water. A waterproof socket is recommended.
- During use, please fully insert the power plug into the power socket and keep the power plug in good contact with the socket, otherwise it may cause electric shock or fire.
- When unplugging the power plug from the socket, hold the plug body and do not apply tension to the power cord.
- To prevent this product from short circuit, when moved to a room from a cold or moist place, it should be left in the room for 2 hours at first to allow the condensate inside the unit to evaporate fully, and then turned on.
- If the product produces abnormal noise, abnormal odor, abnormal temperature or malfunction, please stop using it immediately, unplug the power plug, close the water supply valve, and contact the service provider in time.

Caution



- Please disconnect the power plug when it thunders.
- Do not place this product at a place where it may fall or be pulled into a bathtub or sink.
- Do not place this product in water or other liquids.
- Do not touch this product when it has fallen into or immersed in water. Disconnect the power plug immediately.
- Do not stand on the toilet or strike the ceramic with heavy force, so as to prevent the toilet from damage and water leakage.
- Never embed a cementitious material (cement mortar) in the base of the toilet. Otherwise, the ceramic may crack due to expansion.
- Never apply a heavy force or impact to the toilet. Do not stand on the seat, lid or main unit. Do not place any heavy objects on the toilet.
- Never clean this product with banana oil, gasoline, chemical and detergent, insecticide, toilet cleaner and hard brush.
- Do not use the water other than the GB 5749 standard tap water. Otherwise, it may cause problems such as system failure or skin irritation.
- Do not expose this product to the sunlight directly, to prevent it from discoloration.
- The seat and lid of this product have a feature of slow descent, and do not press them forcibly so as to prevent the descender from being damaged.
- Do not connect the water inlet hose to the water outlet pipe of the water heater, where the inlet water temperature is 3-35°C, and the built-in heating assembly may not work when the temperature exceeds the specified range.
- When using this product, do not lean back on the lid to avoid damaging this product.
- Do not flush objects likely to cause blockage, such as toilet paper, paper urine pad, and maternity sanitary napkins, into the toilet.



- Disconnect the power plug and close the water supply valve before installing, disassembling, repairing and maintaining this product.
- Do not use this product in an environment below 0°C. If the room temperature is below 0°C, the water in the water tank must be drained completely to prevent the water tank from freezing and cracking. Please provide heating measures to increase the temperature of the washroom in order to prevent frost damages.
- If this product is not used for a long time, the power must be disconnected and the water in the water tank must be drained completely.
- In the event of being used by a person with physical, sensory, intellectual deficiencies or lack of experience and common knowledge (including children), this product needs to be used under the regular supervision of a person. Patients with heart diseases should use this product with caution.
- Do not allow children to play with this product.
- Please drain water and clean the water inlet pipe before use to avoid blockage.
- Before use, please drain water and clean the inlet pipe to avoid blockage.

Tools and Materials Required (not supplied)

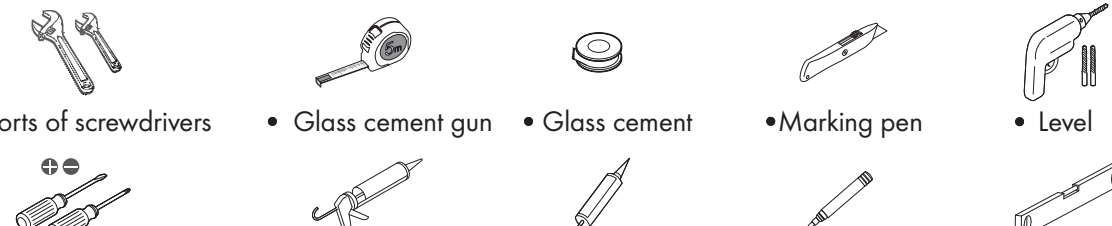
- Adjustable wrench × 2
 - Measuring tape
 - Teflon tape
 - Utility knife
 - Drill
 - Sorts of screwdrivers
 - Glass cement gun
 - Glass cement
 - Marking pen
 - Level
- 

Dimensions

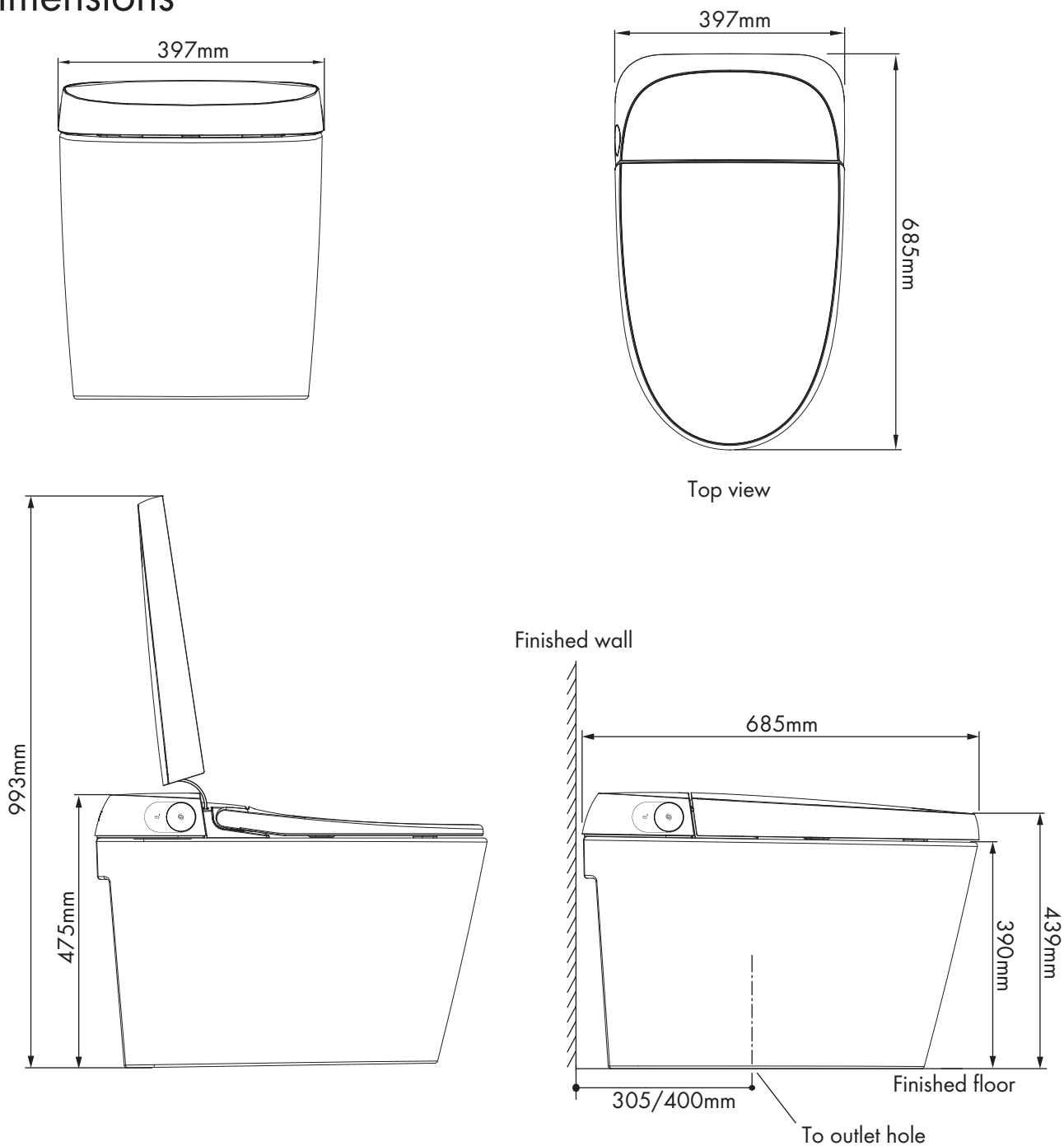

Notes: 1. The sketch provided in the manual of this product is for reference only, and we reserve the right of modifying the form of this product.
 2. If there is any change to the appearance of this product, the actual product shall prevail.

Technical Specifications

Article No.		22486007	22487007
Rough-in distance		305mm	400mm
Rated power supply		AC 220V 50 Hz	
*Rated power		110W	
length of water inlet hose		appr. 650mm	
length of power cord		appr. 1.4m	
Overall unit waterproof		IPX4	
Ceramic toilet	**Flush volume	3.8L (Full 4.8L/Half 3.3L)	
	Water efficiency level	1 level	
	Water inlet method	Direct to water supply	
	Flushing mode	Siphonic jet	
	Outside diameter of drain outlet	80~95mm	
	Drainage method	Down-drain	
Functional section	Heated seat	Surface temperature	Temperature adjusting range: OFF/appr. 31-39°C
		Heating power	50W
		Heated burning protection	After 10 minutes of use, the seat temperature automatically decreases to a low level slowly (about 31 ° C)
		Safety device	Seating sensor, temperature sensor, thermal fuse, thermostat, leakage protection
Caring device	Automatic flushing		Automatic flushing
	Close lid flush function		Close the toilet lid to flush
	Flushing upon power off		Manual close lid flushing (It needs to be connected to a battery compartment for use. The batteries in the battery compartment need to be purchased separately.)
Inlet water pressure		0.02MPa(hydrodynamic pressure) - 0.8MPa(hydrostatic pressure)	
Inlet water temperature		3°C-35°C	
Ambient temperature		1°C-40°C	
***Bacteriostatic site		Seat、 Ceramic glaze	
Product Dimensions		685 mm (length) × 397 mm (width) × 475 mm (height)	
Product Weight		38kg	
Product Standards		GB/T 4706.1-2024 / GB/T 4706.53-2024	

Description:

* Rated power: This product is operated under the conditions of ambient temperature of 23 °C and inlet water static pressure of 0.18MPa±0.02MPa. After powering on, set the seat ring temperature to the highest level and immediately start a full flush, the measured average power of continuous and stable operation for one flush cycle.

** Flush volume: The flush volume of this product is 3.8L (Full 4.8L/Half 3.3L), excluding pre-mist water consumption.

*** Seat: Effectively resist the breeding of Escherichia coli/Staphylococcus aureus according to the Antibacterial performance requirements in ISO 22196-2011 standard.

Ceramic: According to the Antibacterial performance requirements in JC/T 897-2014 Antibacterial Ceramic Products Antibacterial Performance, it can effectively resist the breeding of Escherichia coli and Staphylococcus aureus.

Sketch

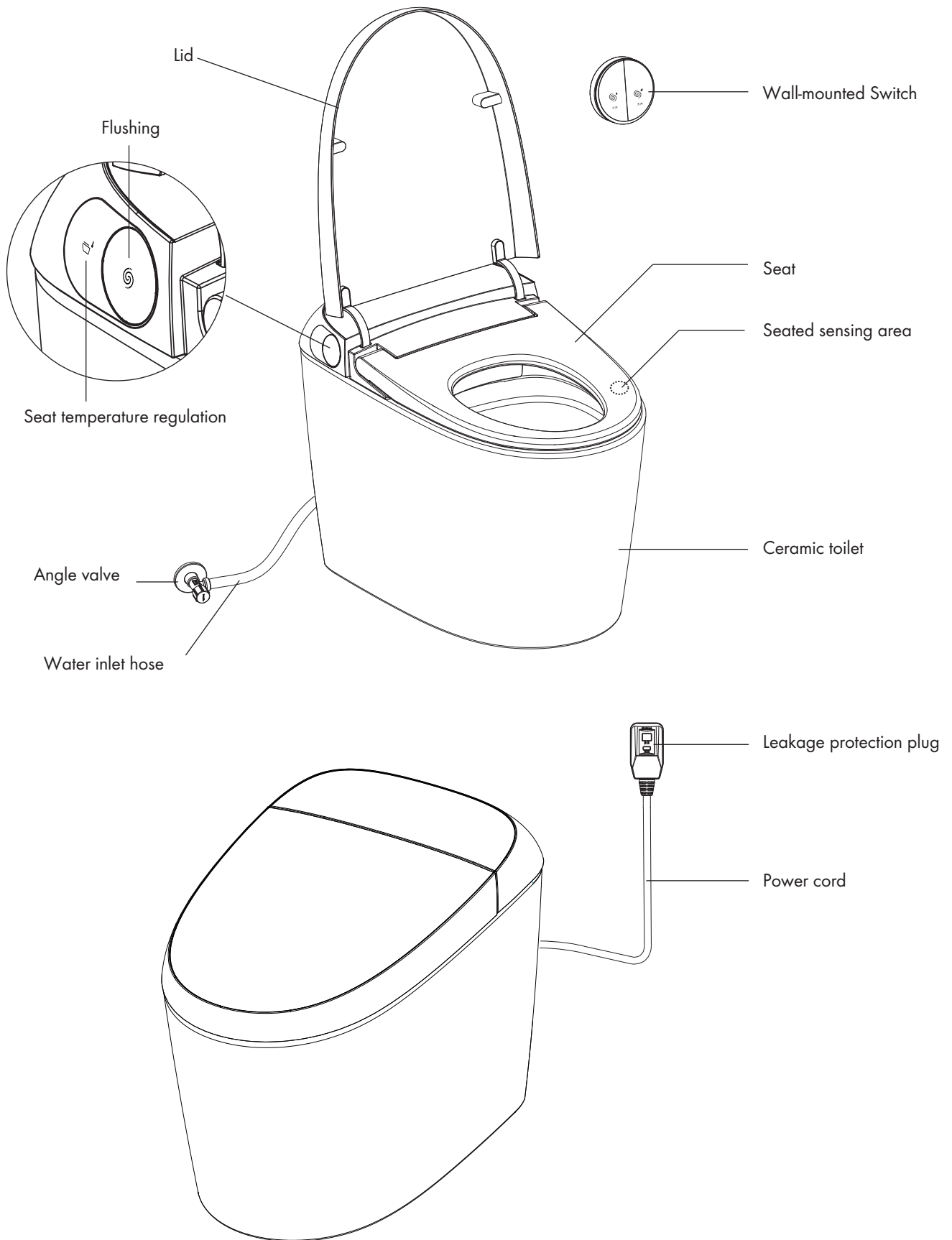

List of Materials

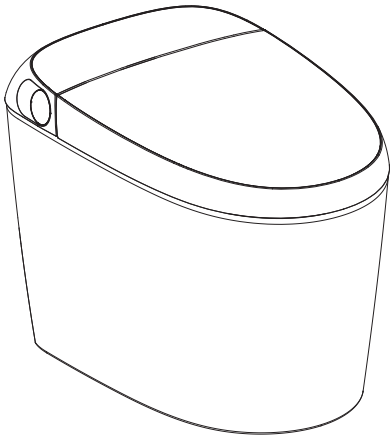

Main unit

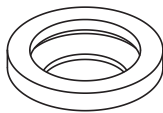

Sealing flange



Angle valve



Alignment hole cardboard



Manual



Warranty card
(included in the manual)



Certificate



Wall-mounted Switch

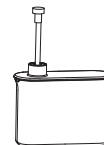

Power outage flushing
battery box

Installation of the ceramic toilet

1. Installation of the mating angle valve

Tips: 1. If the wall has been installed with the old angle valve, it needs to be replaced by professionals to avoid improper disassembly resulting in the inability to install the angle valve.

2. Must use the mating angle valve, otherwise it may cause the pipeline blockage.

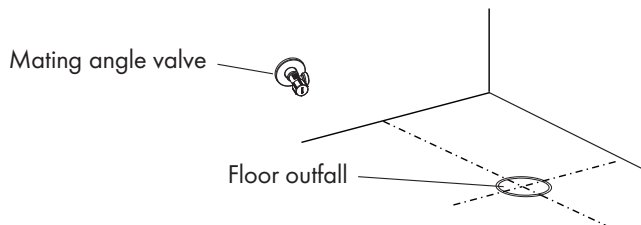

2. Installation of alignment hole cardboard

Measure the floor levelness with a horizon, to make sure the floor of the installation area is level.

Align the alignment hole cardboard with the center line of the outfall, draw a corresponding contour line based on the alignment hole cardboard, and then remove the cardboard.

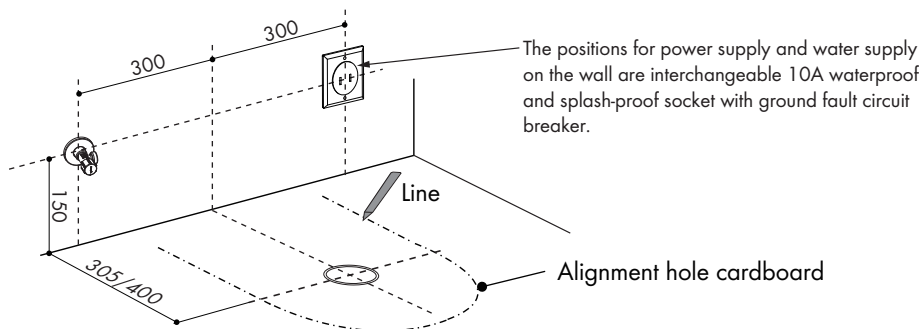

3. Installation of ceramic toilet

Insert the sealing flange into the drain outlet of the toilet;

Mount the toilet to the corresponding position according to the drawn contour line.

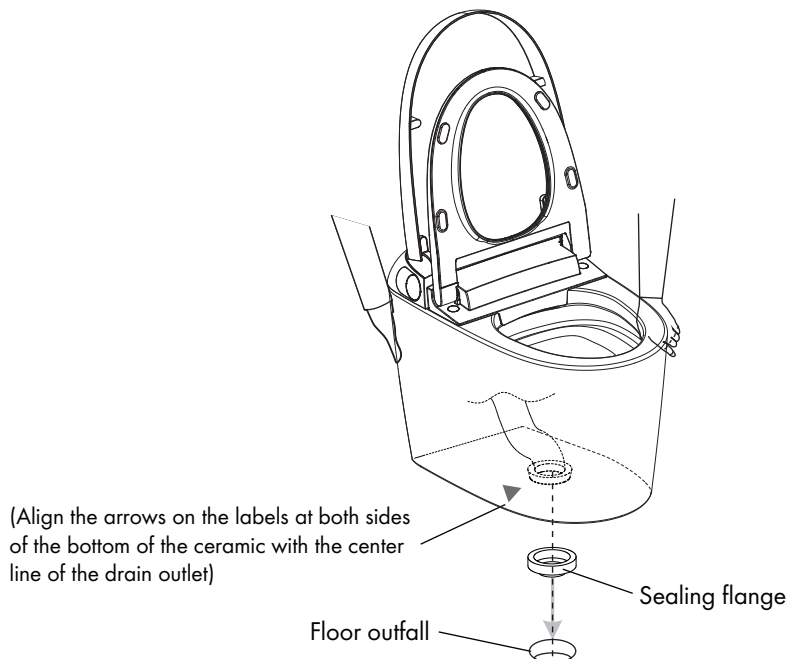

Tips: It is suggested to lift and open the seat by two persons since the one-piece toilet is heavy.

It is strictly forbidden to carry the product from the seat cover part (it is easy to cause mechanical failure).

4. Installation of water inlet hose

Connect water inlet and angle valve with new hose and tighten them.

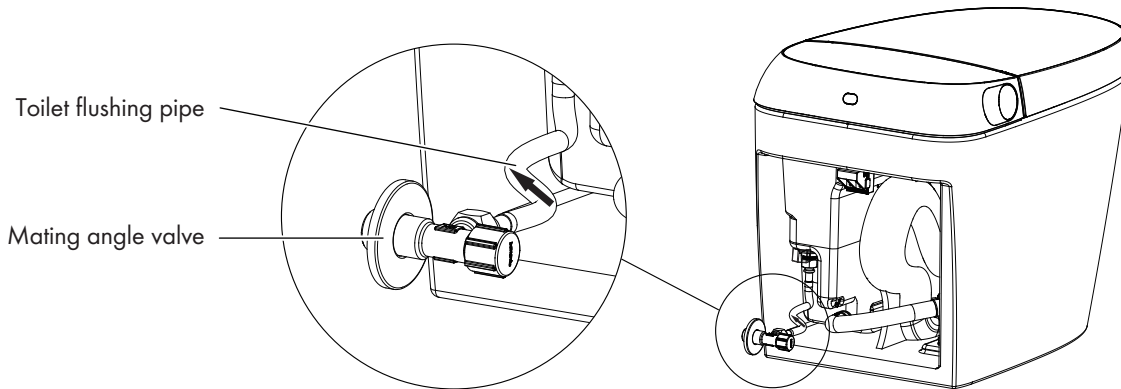

5. Application of the glass glue cement

Apply high-quality mildew-proof glass cement around the lower edge of the toilet.

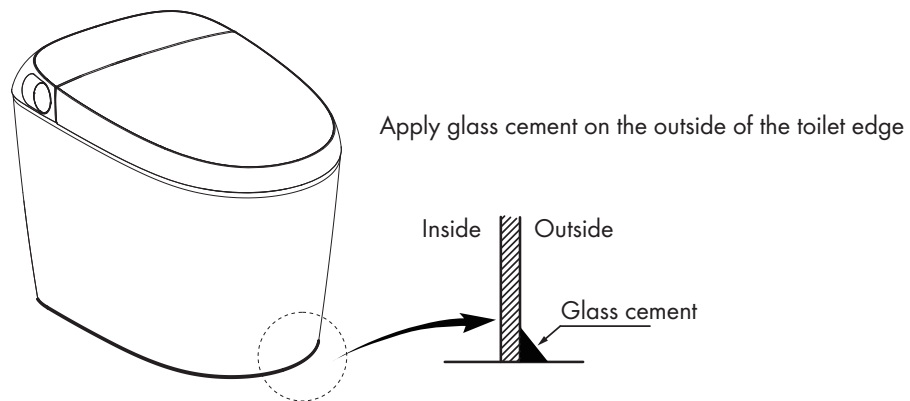

Tips: Clean the garbage and other dirt on drain outlet; and when installing the toilet, make sure the drain outlet of the toilet drain and the floor outfall are installed in place.

Wall-mounted Switch Installation Method

Clean and dry the reserved wall-mounted switch installation area on the wall.

Peel off the double-sided adhesive tape on the back of the wall-mounted switch and firmly attach it to the wall.

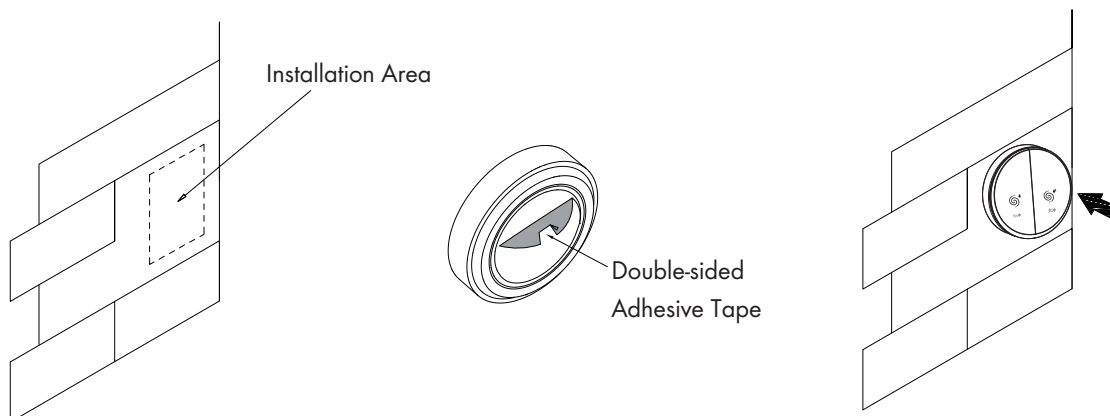

Tips: The wall-mounted switch is self-powered (press-generated), requiring no batteries.

Preparation before Use

1. Turn on the angle valve

To check the tightness of the pipe connections and make sure that there is no water leakage, turn the angle valve counterclockwise to adjust the opening to the maximum.
(Note: The angle valve opens with a large torque for the first time.)

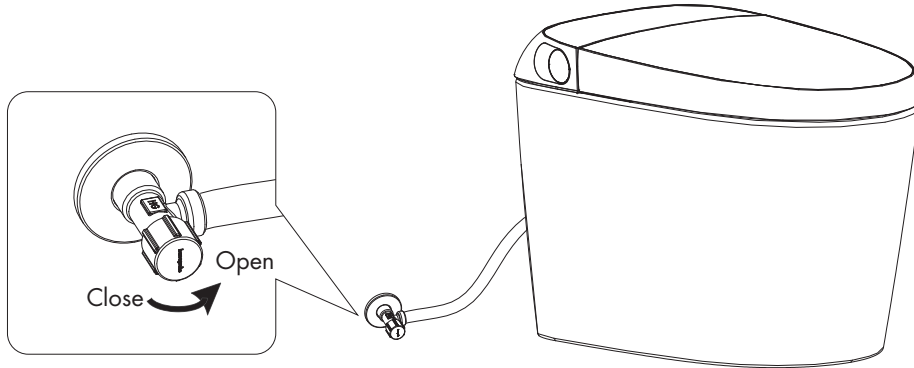

2. Switch on the power supply

Plug the leakage protection plug of the power cord into the power socket, and press the reset button.
If the power indicator light is on, it indicates that the power is on.

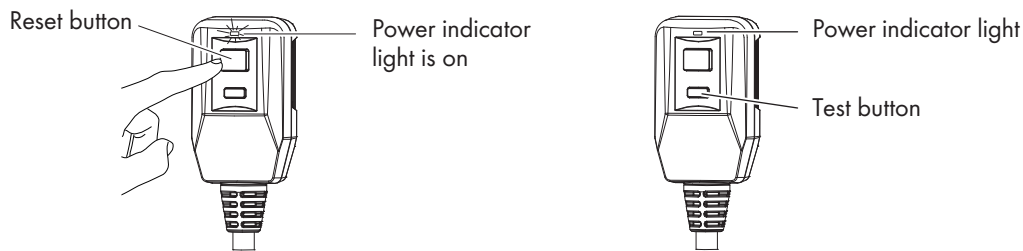

Tips: Press the leakage test button before use. If the reset button bounces, it indicates that the leakage protection function is normal.

3. Safety self-inspection



- ① After power on, the host buzzer beeps, and the self-test begins.
- ② About 10 seconds later, the host buzzer sounds another "beep", the self-test is completed.
- ③ The function mode is on, and the toilet can be used normally.

Close lid flush function

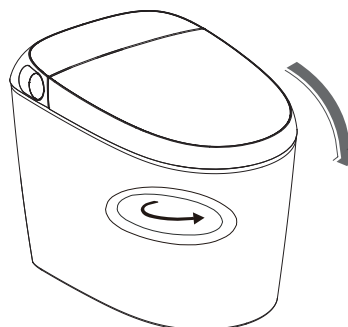
This product can realize the function of flushing with the lid closed.
When the function is turned on:
Close the toilet lid manually to perform full flush.



Wall-mounted Switch instructions

1. Short press "  " button, the toilet starts half flushing.
2. Short press "  " button, the toilet starts full flushing.

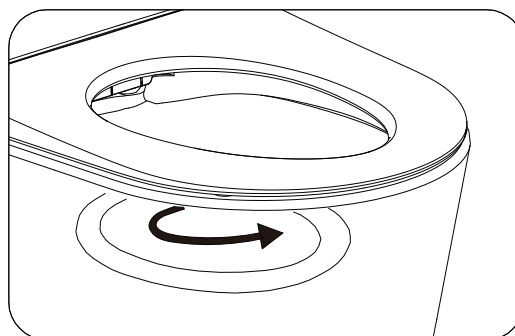
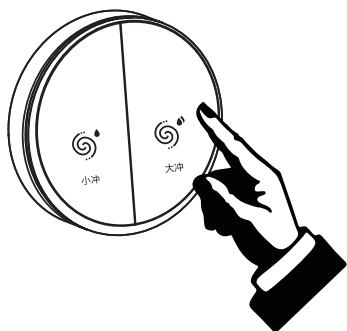

※If pressing the Wall-mounted Switch does not flush the toilet, please toilet are matched.

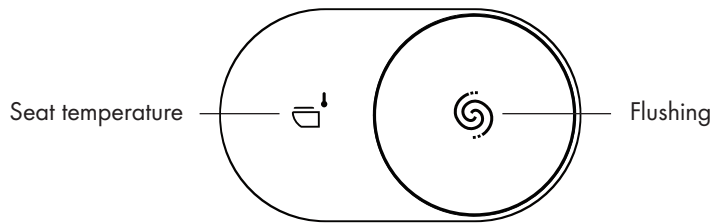

- ① Unplug the power cord to disconnect the main unit.
- ② After 5 seconds, reconnect the power plug and press the "Reset" button on the plug. Once the host powers on and the beep tone completes, press any button on the wall-mounted switch set at least 1 times within 10 seconds.
- ③ The toilet are matched successfully. When the main unit finishes the self-test and beeps, the wall-mounted button can be used.

Functional Buttons of Main Unit



Flushing



1. Short press "  " button, the toilet starts full flushing.
2. After completing the power on self-test for 30 seconds, long press "  " button to turn the close lid flush function on or off. (The default factory setting of close lid flush function is open)

Automatic flushing function

This product can achieve automatic flushing function when leaving the seat.



- When toilet will automatically flush after detecting user leaving the seat.
Seating time 6 seconds to 30 seconds: half flushing; Sitting for more than 30 seconds: full flushing ;
If the sitting time is less than 6 seconds: no flush.
- Within 30 seconds after completing the safety self-test , long press "  " button, to set the automatic flushing function on or off. (The default factory setting of automatic flushing function is open)

Seat temperature adjustment



Short press the "  " button to adjust the seat temperature. Short press this button to adjust seat temperature level from 0 to 3 in cycle. When the seat temperature is in the first gear, toilet generates one short beep. When the seat temperature is in the second gear, toilet generates two short beep. When the seat temperature is in the third gear, toilet generates three short beep. When the seat temperature is in the 0 gear (normal temperature), toilet generates one long beep.

Automatic pre-wetting

Long press "  " and "  " buttons more than 3 seconds, to turn the automatic pre-wetting on/off. After automatic pre-wetting is turned on, ceramic pre-wetting is performed when user seating is detected. (The default factory setting of automatic pre-wetting is open)

Energy saving mode

When there is no operation for 24 hours, it automatically enters energy-saving mode; In energy-saving mode, the seat temperature is in a low temperature state (first gear temperature) to achieve energy-saving purposes. (Note: If the seat temperature is at room temperature before energy saving, it should be maintained at room temperature after energy saving.)

When there is no operation for 48 hours, it automatically enters standby mode; In standby mode, the seat heating is turned off . Automatically restore function mode when used by someone.

Maintenance and Care of Main Unit

1. Cut off the power: Please cut off the power before maintaining the main unit.
2. Wipe with a soft rag: Please wipe the dirty area with a wrung-out soft rag.
3. Safety self-inspection: Please reconnect the power after wiping.
4. If you find that the toilet is moving or shaking during usage, check if the silicone is loosened due to aging, and remove and reapply the silicone if it is loosened.

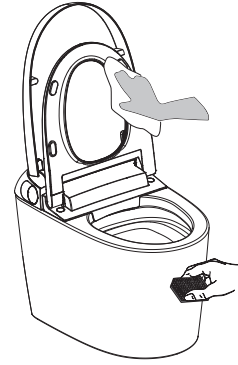

When the electricity and water supply is cut-off

1. How to flush the toilet during interruption of power supply:

1. Install the battery into the power outage flushing battery box

- ① Separate the upper and lower covers of the battery box; install 10 pcs AA batteries, and pay attention to the positive and negative poles when replacing;
- ② After installing the batteries, re-fasten the upper and lower covers of the battery box.

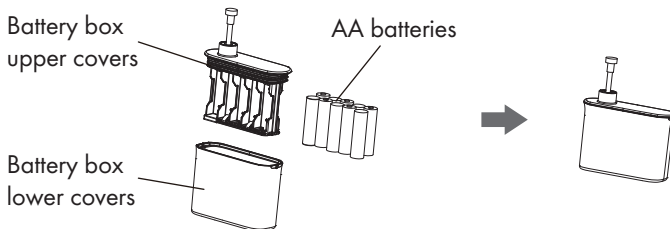

Warm Tips:

- ① The battery box is an external power source for flushing during a power outage. It is recommended to connect it to the main unit for use during a power outage.
- ② This product cannot be charged, and the power supply terminal cannot be short-circuited to avoid danger.
- ③ Before replacing the battery, you need to first separate the connection wires connecting the battery box and the main unit from the plug-in terminals, then remove the battery box cover and take out the old battery.
- ④ Suggested use EXCELL AA batteries. New and old batteries cannot be mixed. Batteries of different models and brands cannot be mixed.
- ⑤ Install the battery strictly according to the "+" and "-" signs in the battery compartment. This product is a series battery pack. The single cell cannot be connected reversely, otherwise it will cause battery damage. In serious cases, there is a risk of battery explosion.
- ⑥ When the battery is exhausted, it should be removed and disposed of safely. Do not discard it at will.
- ⑦ Do not disassemble or install parts other than the battery, otherwise the seal of the battery box may fail, and moisture from the bathroom may enter the box, causing the battery to rust and be damaged.
- ⑧ If not used for a long time, please remove the batteries in the box and keep them properly.
- ⑨ To avoid leakage, it is recommended to replace the batteries every 2 years.
- ⑩ After replacing a new battery, it is expected that 35 power-off flushing functions can be performed. (This is a theoretical number, please refer to actual use).

2. Install the battery box for power outage flushing

- ① Take out the male end (red) of the battery cable at the end of the ceramic back cover;
- ② Connect the battery connecting wire at the cover end to the female end of the power outage flushing battery box connecting wire and tighten

Warm Tips:

Battery connection male and female terminals have positive and negative poles, there are positioning structures within the two terminals, please do not force the insertion, otherwise it may lead to product damage.

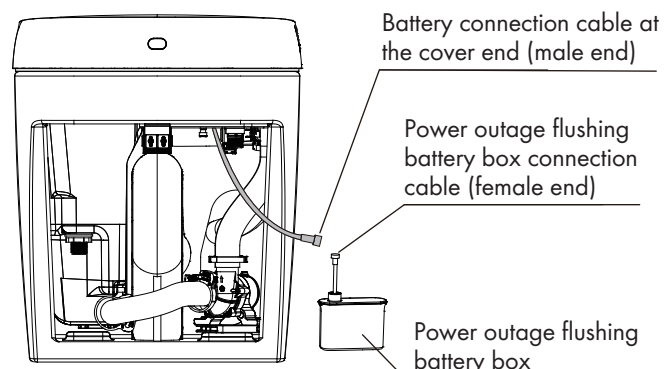

3. Power outage flushing function

Close the toilet lid manually to flush.

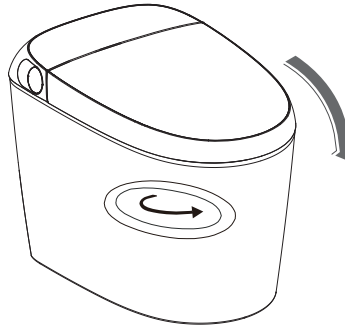

4. Remove the power outage flushing battery box

After power is restored, be sure to remove the power outage flushing battery box and screw back the male (red) terminal cover of the battery connection cable on the main body.

2. How to flush the toilet during interruption of water supply:

Pour the water into a large bucket (about 8 L) and flush the toilet around the bowl face of the toilet. Here, you should take care to prevent water from overflowing from the toilet.

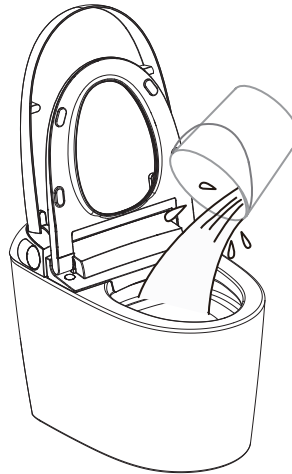

When this product is left unused for a long time

Especially in winter, when you are not at home for a long time, please make sure to drain the water in the water tank and the pipeline to prevent freezing.

To discharge water:

1. Drain out the water inside tank:
Start flushing once.
2. Unplug and cut off the electricity.
3. Drain the water in the pipeline:
loosen the hose from the angle valve, drain the water in the pipeline and reinstall the hose.



4. Dispose of the water in the toilet:
For the sake of safety, it is recommended to pour the antifreeze into the water in the toilet.

Tips: Before drainage, you must cut off the power!

When using the toilet again, please make sure to turn on the water and power again.

Fault Analysis and Solution

Problem	Cause	Solution
The product is not functioning properly	Whether there is a power outage or if the main switch or power plug trips	Recheck the power supply after restoring power supply
	Is the power plug plugged in properly	It should be fully inserted into the power outlet. When re-inserting, please wait for about 10 seconds
	Is there leakage electricity? Is the indicator light on the power plug off?	Unplug the power plug from the socket, press the reset button on the power plug and plug it in again. If it still does not work, pull out the power plug and entrust it to repair
	In standby mode	Please sit on the seat to enter the working mode
The product cannot automatically flush	In standby mode	Please sit on the seat to enter the working mode
	Please confirm if there is a water outage	Waiting for water supply to restore
Low seat temperature	The seat temperature is set at the normal temperature level	Reset the seat temperature
	In standby or energy save mode	Switch to the function mode and use it after 3 minutes
 Caution	If the fault still exists after taking the measures above, you should cut off the power, and contact the service provider to ask a professional to repair it.	
	If the power leakage protection switch often trips, this product is indicated to undergo electric leakage. Please cut off the power, and contact the service provider to ask a professional to repair it.	

Information table of hazardous substances in electrical and electronic products

Part Name	Hazardous Substance									
	Lead (Pb)	Mercury (Hg)	Cadmium (Cd)	Hexavalent chromium (Cr(VI))	Polybrominated biphenyl (PBBs)	Polybrominated diphenyl ether (PBDEs)	Diisobutyl phthalate (DIBP)	Dibutyl phthalate (DBP)	Benzyl butyl Phthalate (BBP)	Dihexyl phthalate (DEHP)
Power cord	×	○	○	○	○	○	○	○	○	○
Circuit board	×	○	○	○	○	○	○	○	○	○
Seating sensor	×	○	○	○	○	○	○	○	○	○
Temperature sensor	×	○	○	○	○	○	○	○	○	○
Temperature protector	○	○	×	○	○	○	○	○	○	○
Water inlet hose	×	○	○	○	○	○	○	○	○	○
Expansion bolt	×	○	○	○	○	○	○	○	○	○
Angle valve	×	○	○	○	○	○	○	○	○	○

Note 1: ○: Indicates that the content of the hazardous substance in all homogeneous materials of the component does not exceed the requirements of the national standard for the restriction of the use of hazardous substances in electrical and electronic products.
 ×: Indicates that the content of the hazardous substance in at least one homogeneous material of the component exceeds the requirements of the national standard for the restriction of the use of hazardous substances in electrical and electronic products.

Note 2: For components not listed above, their hazardous substance content does not exceed the requirements of the national standard for the restriction of the use of hazardous substances in electrical and electronic products.

Environment-Friendly Use Period

The number of years in this symbol is based on the environment-friendly use period provided in SJ/T 11364-2024 Marking for the Restriction of the Use of Hazardous Substances in Electronic and Electrical Products.

As long as the safety and use precautions of this product stated in the manual are observed, the leakage or sudden change of hazardous substances due to the use of this product will not occur during this period from the date of manufacture, and the serious pollution to the environment and the injuries and property losses to the user will not be caused.

[Environment-Friendly Use Period] It is neither a safety service life nor a quality guarantee period. When this product is not suitable for continued use and needs to be discarded, please dispose it in accordance with the legal regulations related to the recycling of electrical and electronic products. Thank you for your cooperation.

Note: The product you have purchased may not contain all of the components above, which depends on the product model.

Grade of the energy efficiency and water efficiency

Our toilet products meet the requirements of GB 38448 "Minimum allowable values and grades of the energy efficiency and water efficiency for smart water closets".

Please refer to the water efficiency label attached to the product for details.

About Micro-Power Short-Range Radio Transmitter Equipment

1. Depending on the product you purchase, different products may be equipped with one or more of the following micro-power short-range radio transmitting devices. The use of micro-power short-range radio transmitting devices must comply with relevant national radio management regulations. This product is only for use in home bathrooms.
 - ① The remote control belongs to "(I) General Micropower Equipment - Class 6.F Equipment" in the "Catalogue and Technical Requirements for Micropower Short-range Radio Transmitter Equipment". The antenna type is a PCB (printed circuit board) onboard antenna, and the power supply voltage is 2 or 3 PCS 1.5V dry batteries, 3.7V lithium batteries, 3V button batteries. For details, please refer to the battery installation and use instructions.
 - (1) Operating frequency: 2400-2483.5 MHz.
 - (2) Transmitting power limit: 10 mW (e.i.r.p.).
 - (3) Frequency tolerance: 75 kHz.
 - ② Microwave sensors belong to "(I) General Micropower Equipment - Class 8.H Equipment" in the "Catalogue and Technical Requirements for Micropower Short-range Radio Transmitter Equipment". The antenna type is a PCB (printed circuit board) onboard antenna, and the power supply voltage is 5V.
 - (1) Operating frequency: 24-24.25 GHz.
 - (2) Transmit power limit: 20 mW (e.i.r.p.).
2. It is not allowed to change the usage scenario or conditions, expand the transmission frequency range, increase the transmission power (including installing an additional RF power amplifier), or change the transmission antenna without authorization.
3. It shall not cause harmful interference to other legal radio stations, nor claim protection from harmful interference.
4. This device can withstand interference from industrial, scientific and medical (ISM) application equipment that radiates radio frequency energy or other legal wireless radio stations.
5. If harmful interference is caused to other legal radio stations, the use shall be stopped immediately and measures shall be taken to eliminate the interference before the use can be continued;
6. When using micro-power equipment in aircraft and in electromagnetic environment protection areas of radio astronomy stations, meteorological radar stations, satellite earth stations (including measurement and control, ranging, receiving, and navigation stations), other military and civilian radio stations (stations), airports, etc. established in accordance with laws, regulations, and relevant national provisions and standards, the regulations of the electromagnetic environment protection and relevant industry authorities shall be observed.
7. It is prohibited to use any model remote controller within a radius of 5,000 meters with the center of the airport runway as the center (this product does not involve model remote controllers).
8. The ambient temperature range for this device is 0 °C to 40 °C.

Warranty Card

Model No.		Customer Name	
Seller		Purchasing Date	
Invoice No.		Customer Contact No.	
Distributor Stamp		Distributor Contact No.	

Thank you for purchasing our product! To maintain our product reputation and protect your consumer rights, we will provide you with three-year (for the electric appliance) or five-year (for the ceramic section) free warranty service. Please feel free to use. Where this product malfunctions when you use it normally according to the manual and precautions for use, it can be repaired free of charge during the warranty period. Where this product needs to be repaired due to faults during the warranty period, you can contact our company with the warranty card and the original invoice for free repair or replacement (it may be replaced with a similar model if the same model is not available, and we reserve this right).

In the event of exceeding the warranty period or losing the warranty card, we also provide you with a repair service, which will be charged at cost.

This limited liability applies only to mainland China (excluding Hong Kong, Macau and Taiwan).

The undertaking of the limited liability for the product of our company applies to our product purchased by you, and the repairs will be charged during the warranty period under the following conditions:

1. Damages caused by improper use, maloperation or improper repair or modification.
2. Damages caused by moving the installation location.
3. Damages caused by fires, earthquakes, floods, lightning strikes, freezing and other natural disasters, public nuisances and gas disasters, sulfuric acid, hydrochloric acid, and abnormal voltage.
4. Damages caused by the use of power sources other than the specified power source (voltage, frequency).
5. Damages caused by the uses other than the general household or hotel uses.
6. Damages caused by improper uses incurred from silting-up sand and dirt and consumables such as packaging.



National Service Hotline: 400-820-3555

To protect your service rights, please scan the code and register
the product in time after installation.

hansgrohe

Hansgrohe · Auestraße 5 – 9 · D-77761 Schiltach · Telefon +49 (0) 78 36/51-1282 · Telefax +49 (0) 7836/511440
E-Mail: info@hansgrohe.com · Internet: www.hansgrohe.com