

EN Instructions for use / Assembly instructions

DE Gebrauchsanleitung / Montageanleitung

2

3

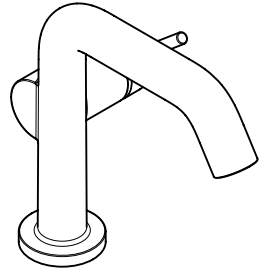

Tecturis S 110 Fine CoolStart

73320XX9 / 73321XX3

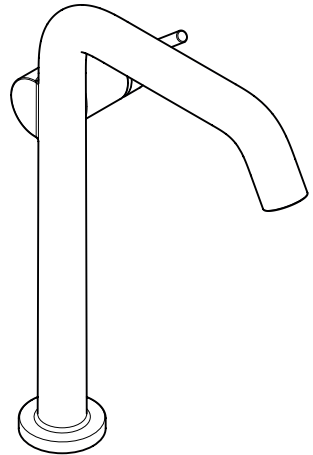

Tecturis S 240 Fine CoolStart

73370XX9 / 73372XX3



Safety Notes

- ⚠ Gloves should be worn during installation to prevent crushing and cutting injuries.
- ⚠ The product may only be used for bathing, hygienic and body cleaning purposes.
- ⚠ The hot and cold supplies must be of equal pressures.

Installation Instructions

- Prior to installation, inspect the product for transport damages. After it has been installed, no transport or surface damage will be honoured.
- The pipes and the fixture must be installed, flushed and tested as per the applicable standards.
- The plumbing codes applicable in the respective countries must be observed.
- The drain valve must only be used as intended. It is not allowed to attach other objects to the drain valve, for example a semi-pedestal.
- The drain valve may only be installed in basins with an overflow opening.

Technical Data

Operating pressure:	max. 1 MPa
Recommended operating pressure:	0,1 - 0,5 MPa
Test pressure:	1,6 MPa

(1 MPa = 10 bar = 147 PSI)

Hot water temperature: max. 60 °C
 Thermal disinfection: 70 °C / 4 min
 The product is exclusively designed for drinking water!

Symbol description



Do not use silicone containing acetic acid!



Dimensions (see page 6)



Flow diagram (see page 5)



Spare parts (see page 7)

XX = Colors
 00 = Chrome Plated
 14 = Brushed Bronze
 67 = Matt Black
 82 = Brushed Nickel



Cleaning (see page 8)



Operation (see page 5)

Hansgrohe recommends not to use as drinking water the first half liter of water drawn in the morning or after a prolonged period of non-use.

Fault	Cause	Remedy
Insufficient water	- Aerator calcified, dirty	- Clean aerator, replace as necessary
Mixer stiff	- Cartridge defective, calcified	- Exchange cartridge
Mixer dripping	- Cartridge defective	- Exchange cartridge
Water escaping at the threaded base	- connection hoses not completely screwed into basic body	- Tighten connection hoses by hand
	- O-ring at the connection hose defective.	- Exchange O-ring
Hot water temperature too low	- Hot water limiter incorrectly set	- Set hot water limiter



Sicherheitshinweise

- ⚠ Bei der Montage müssen zur Vermeidung von Quetsch- und Schnittverletzungen Handschuhe getragen werden.
- ⚠ Das Produkt darf nur zu Bade-, Hygiene- und Körperreinigungszwecken eingesetzt werden.
- ⚠ Große Druckunterschiede zwischen den Kalt- und Warmwasseranschlüssen müssen ausgeglichen werden.

Montagehinweise

- Vor der Montage muss das Produkt auf Transportschäden untersucht werden. Nach dem Einbau werden keine Transport- oder Oberflächenschäden anerkannt.
- Die Leitungen und die Armatur müssen nach den gültigen Normen montiert, gespült und geprüft werden.
- Die in den Ländern jeweils gültigen Installationsrichtlinien sind einzuhalten.
- Das Ablaufventil darf nur zum bestimmungsgemäßen Gebrauch verwendet werden. Das Befestigen von anderen Gegenständen z. B. einer Halbsäule an dem Ablaufventil ist nicht zulässig.
- Das Ablaufventil darf nur in Waschbecken mit Überlauf eingesetzt werden.

Technische Daten

Betriebsdruck:	max. 1 MPa
Empfohlener Betriebsdruck:	0,1 - 0,5 MPa
Prüfdruck:	1,6 MPa
	(1 MPa = 10 bar = 147 PSI)
Heißwassertemperatur:	max. 60°C
Thermische Desinfektion:	70°C / 4 min

Das Produkt ist ausschließlich für Trinkwasser konzipiert!

Symbolerklärung



Kein essigsäurehaltiges Silikon verwenden!

Maße (siehe Seite 6)

Durchflussdiagramm (siehe Seite 5)

Serviceteile (siehe Seite 7)

- XX = Farbcodierung
- 00 = Chrom
- 14 = Brushed Bronze
- 67 = Mattschwarz
- 82 = Brushed Nickel

Reinigung (siehe Seite 8)

Bedienung (siehe Seite 5)



Hansgrohe empfiehlt, morgens oder nach längeren Stagnationszeiten den ersten halben Liter nicht als Trinkwasser zu verwenden.

Störung	Ursache	Abhilfe
Wenig Wasser	- Luftsprudler verkalkt, verschmutzt	- Luftsprudler reinigen / austauschen
Armatur schwergängig	- Kartusche defekt, verkalkt	- Kartusche austauschen
Armatur tropft	- Kartusche defekt	- Kartusche austauschen
Wasseraustritt am Befestigungsschaft	- Anschlusschläuche nicht ganz in den Grundkörper eingeschraubt	- Anschlusschläuche von Hand festziehen
	- O-Ring am Anschlusschlauch defekt	- O-Ring austauschen
Zu niedrige Warmwassertemperatur	- Warmwasserbegrenzung falsch eingestellt	- Warmwasserbegrenzung einstellen

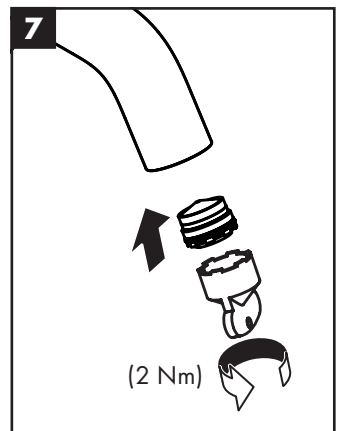
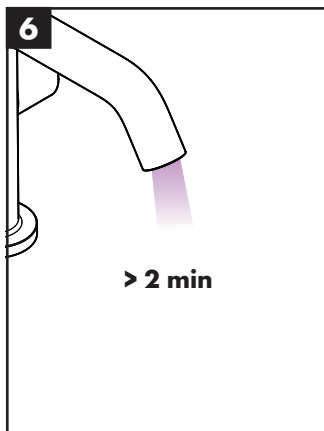
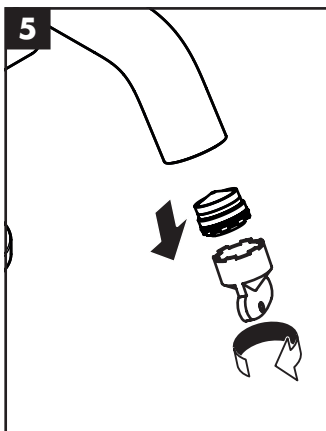
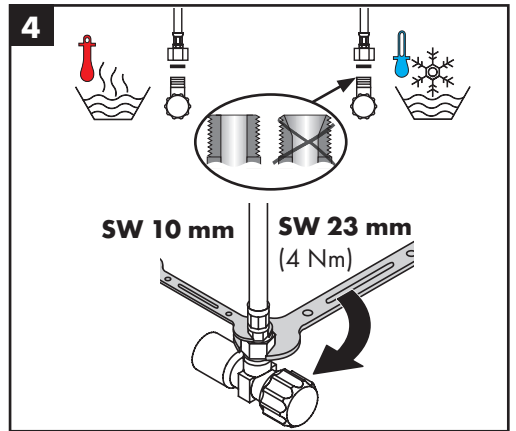
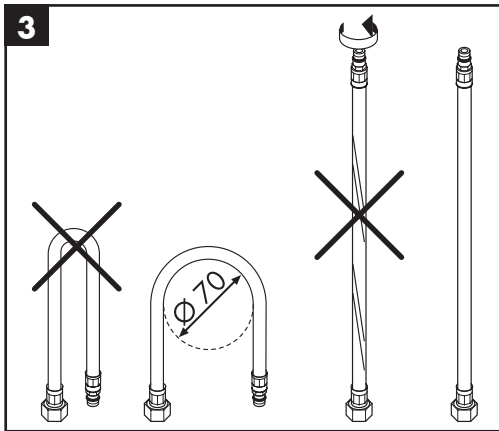
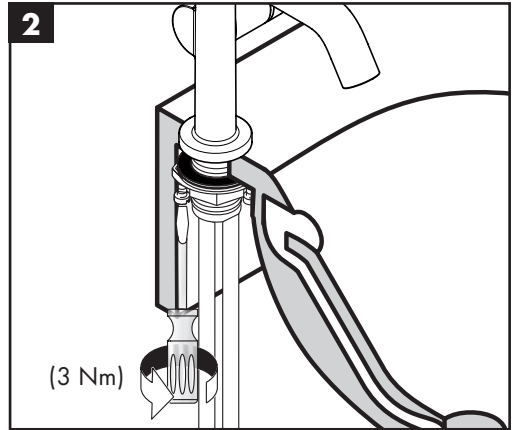
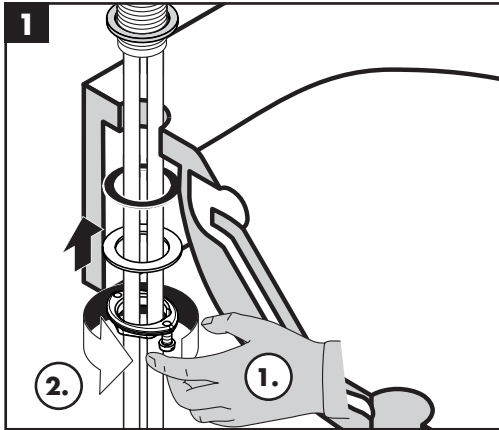

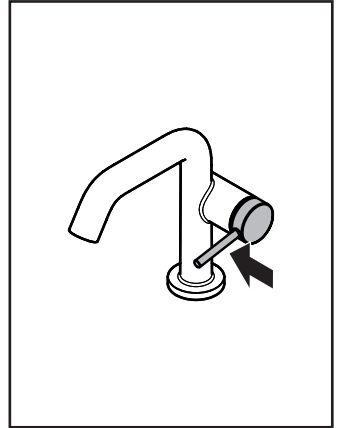
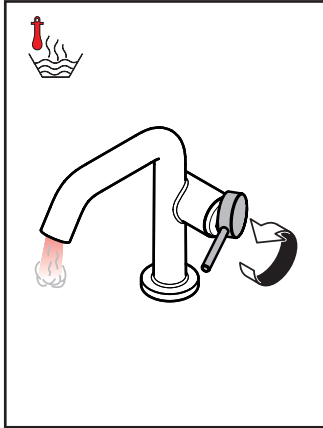
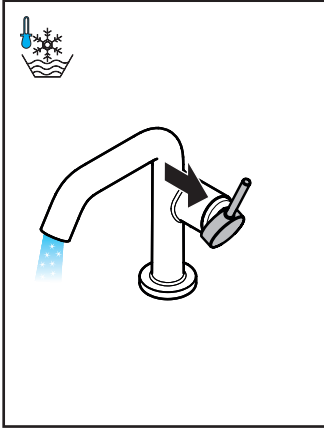

Tecturis S 110 Fine CoolStart

73320XX9 / 73370XX9

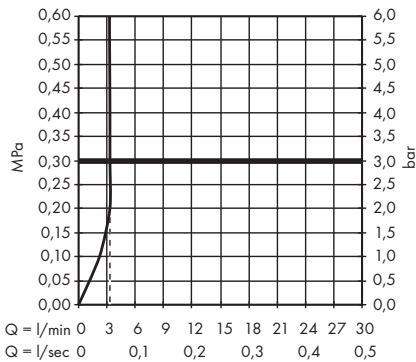

Tecturis S 240 Fine CoolStart

73321XX3 / 73372XX3

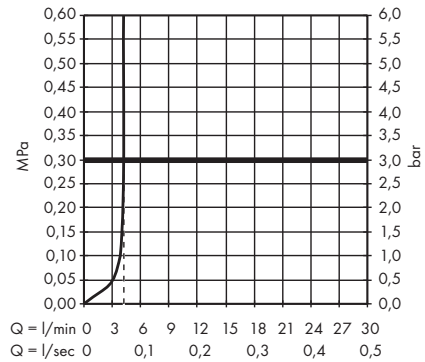



Tecturis S 110 Fine CoolStart

73320XX9 / 73321XX3

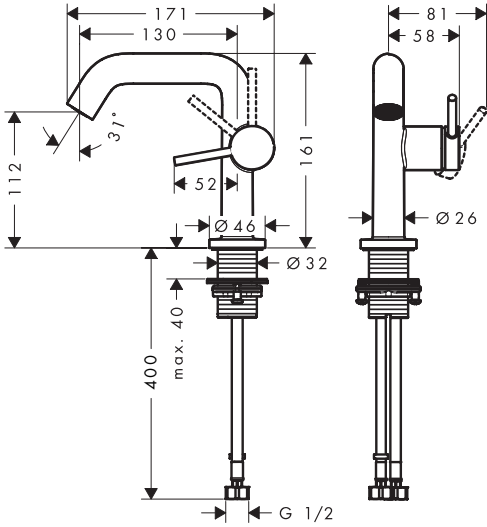

Tecturis S 240 Fine CoolStart

73370XX9 / 73372XX3

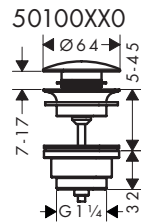
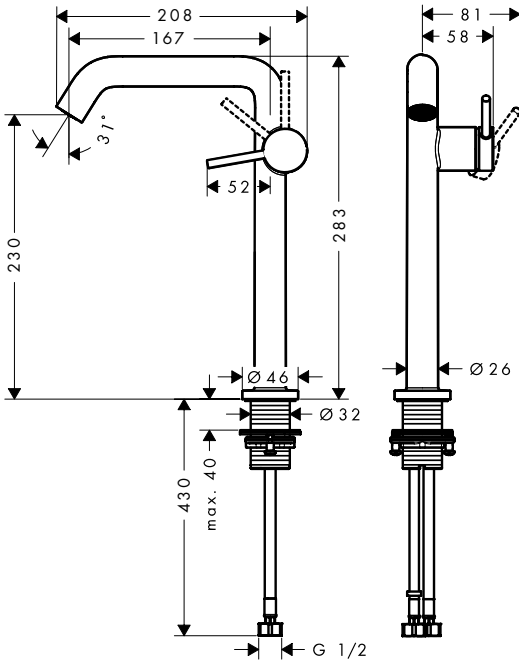



Tecturis S 110 Fine CoolStart

73320XX9 / 73321XX3

Tecturis S 240 Fine CoolStart

73370XX9 / 73372XX3

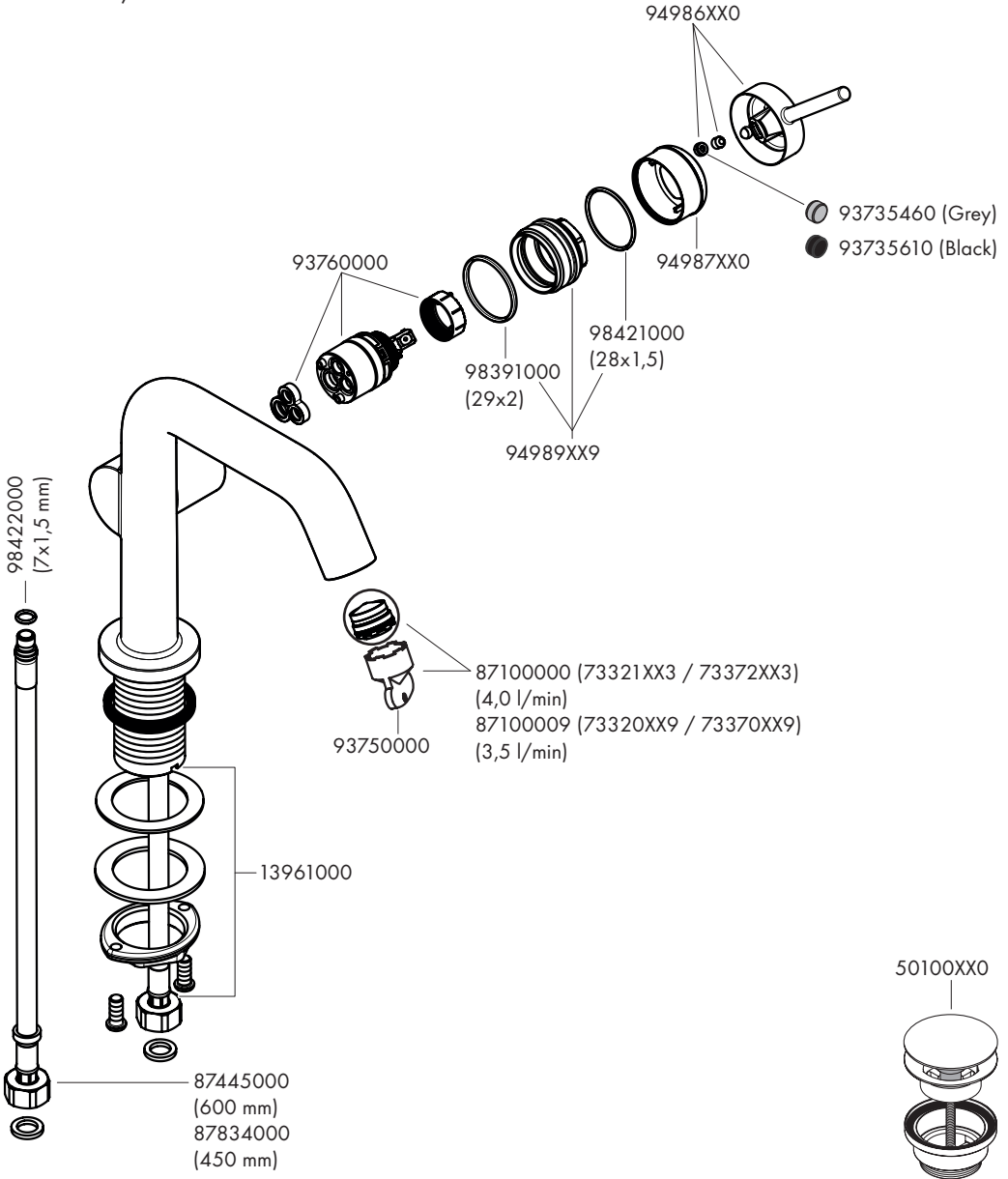



www.hansgrohe.com/cleaning-recommendation

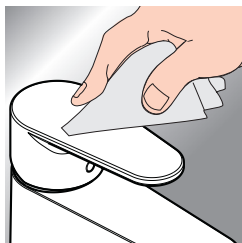

EN Cleaning recommendation / Warranty / Contact

DE Reinigungsempfehlung / Garantie / Kontakt

