

**ZH** 组装说明

**EN** Assembly instructions

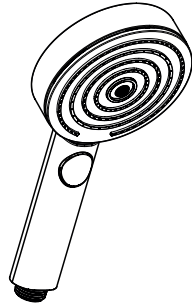

**Pulsify 105 3jet Activation**  
24101XX7

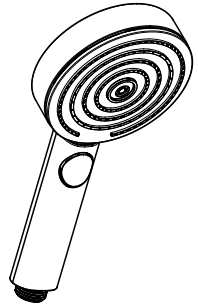

**Pulsify 105 3jet Relaxation**  
24111XX7

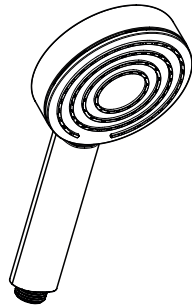

**Pulsify 105 1jet**  
24121XX7

## 汉斯格雅产品的清洁建议

现代的卫浴龙头, 厨房龙头, 花洒, 配件, 盥洗台, 洗涤盆, 浴盆和加热器采用的制造材料非常迥异, 以适应产品外形设计和使用功能的市场需求。

为了避免产品损坏和由此引发的投诉及争议, 必须在使用和清洁产品时遵循有关规程。

### 在保养汉斯格雅产品时, 原则上必须注意:

- 只能使用那些有明确注明是适用于本产品的清洁剂。
- 不允许使用含有盐酸, 蚁酸, 浓氢氧化钠, 氯漂或醋酸的清洁剂, 因为这些清洁剂会给产品表面造成严重的损伤。
- 含磷酸的清洁剂必须在特定条件下使用。
- 不允许将两种以上清洁剂混合使用。
- 不允许使用具有研磨作用的清洁工具和设备, 如不适合的清洁粉末, 海绵垫或超细麦克布。
- 务必遵守清洁剂制造商的安全说明。
- 严格遵守清洁剂的用量和作用时间, 决不允许清洁剂的作用时间长于规定值。
- 定期的清洁以预防水垢。
- 不允许将清洁剂直接喷射到汉斯格雅产品上, 因为喷雾会进入汉斯格雅产品的开口部分和缝隙中而造成损害。首先将清洁剂喷在软布上, 再用软布进行清洁。
- 清洁之后必须用足够的清水冲洗, 以彻底去除残留的吸附物(清洁剂)。
- 不允许使用蒸汽清洗机, 高温会损害产品。

## 重要说明

肥皂, 洗发水, 沐浴液, 染发剂, 香水, 刮胡水, 指甲油的残留也会对产品造成损伤。

此处: 使用后要小心地用清水将剩余物冲洗干净。

同样在产品下方不得存放洗涤剂 and 化学药品, 例如不可放在用于洗脸盆的梳洗柜中否则挥发气体将损坏产品。

在已经损伤的表面继续使用清洁剂会给表面造成更大的损伤。



表面损坏的部件必须更换, 否则会有受伤的危险。

不按规定进行清洁而造成的任何损坏不在本公司产品保修范围之内。

## 担保

Hansgrohe向用户保证, 该产品无制造缺陷。如果在担保期内出现缺陷, Hansgrohe将免费进行售后处理, 保证条件和详情见

[www.hansgrohe.com.cn/service/producer-quarantee](http://www.hansgrohe.com.cn/service/producer-quarantee)。在提出保修的权利时请联系您的合同方。本保证不涉及及有关国家法律规定的消费权益。

## QuickClean

有了QuickClean, 手工清洁功能, 要去掉喷头上的水垢, 只需简单地搓除即可。

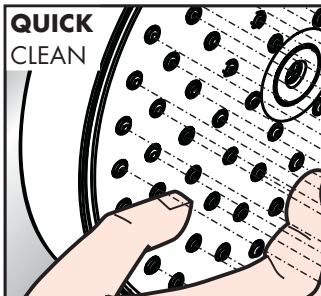
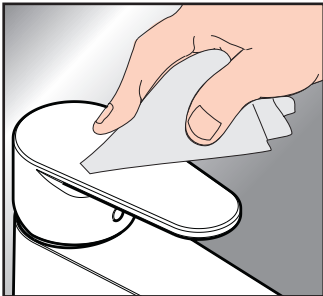

## Cleaning Recommendation for Hansgrohe Products

Today, modern sanitary and kitchen tapware, showers, accessories, washstands, sinks, tubs and radiators consist of very different materials to comply with the needs of the market with regard to design and functionality.

To avoid damage and reclamations, it is necessary to consider certain criteria when cleaning.

### With regard to caring for the Hansgrohe products, the following must in principle be heeded:

- Only use cleaning material which is explicitly provided for this type of application.
- Never use cleaning materials, which contain hydrochloric acid, formic acid, concentrated caustic soda, chlorine pale lye or acetic acid, as they cause considerable damage.
- Phosphorus acidic cleaners are only conditionally applicable.
- Mixing cleaning agents is not permitted, generally.
- Never use cleaning materials or appliances with an abrasive effect, such as unsuitable cleaning powders, sponge pads or micro fibre cloths.
- The safety instructions of the cleaning agent manufacturers must be strictly followed.
- Cleaning has to be carried out with a specified cleaner dosage, contact time, object-related and adapted to the needs.
- The building up of calcifications has to be removed by cleaning regularly.
- When using spray cleaners, spray the cleaning solution onto a soft cloth or sponge, never directly onto the Hansgrohe products, as the atomised spray could enter openings and gaps in the Hansgrohe products and cause damage.

- After cleaning rinse thoroughly with clean water to remove any cleaner residue.
- The use of steam cleaners is not permitted. The high temperatures can damage the products.

### Important

Residues of toiletries such as liquid soaps, shampoos and shower gels, hair dyes, perfumes, aftershave and nail varnish can also cause damage.

Here too: Carefully rinse with water after use to remove residues.

Likewise, do not store any cleaning agents or chemicals under the products, for example in a vanity unit, as the vapours may damage the products.

The damage of already damaged surfaces will deteriorate under the effect of the cleansers.



**Components with damaged surfaces must be exchanged, otherwise there could be an injury danger.**

Damage caused by improper treatment will not be covered by our guarantee.

### Warranty

Hansgrohe guarantees to the consumer that this product is free of production faults. If any defect is detected within the warranty period, Hansgrohe will remedy this defect free of charge. You will find the conditions and details of this guarantee at [www.hansgrohe.com.cn/service/producer-quarantee](http://www.hansgrohe.com.cn/service/producer-quarantee). Please contact your contracting party to claim your rights under this guarantee. This guarantee does not affect the customer's rights under the respective national legislation.

### QuickClean

The QuickClean cleaning function only needs a small manual rub over to remove the lime scale from the spray channels.

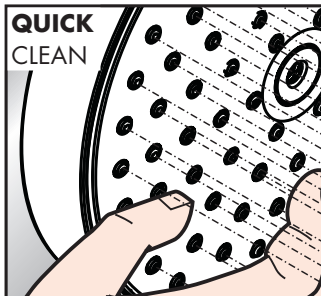
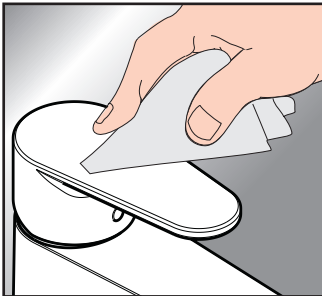

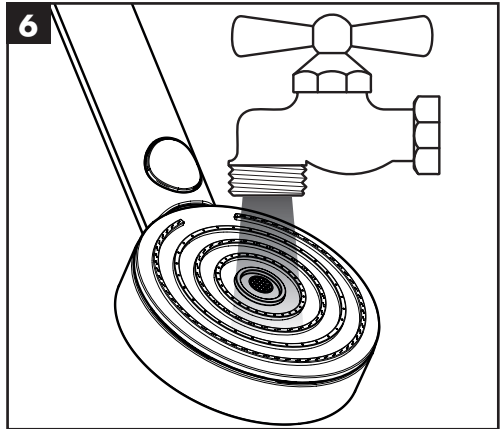
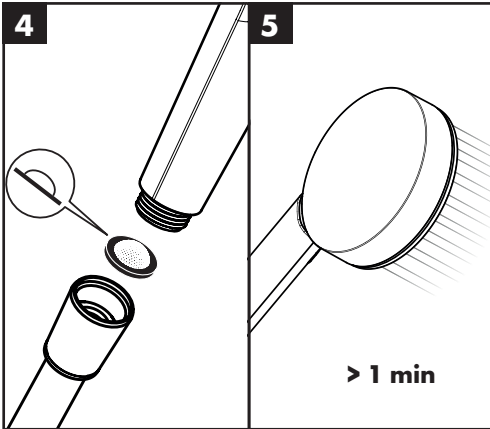
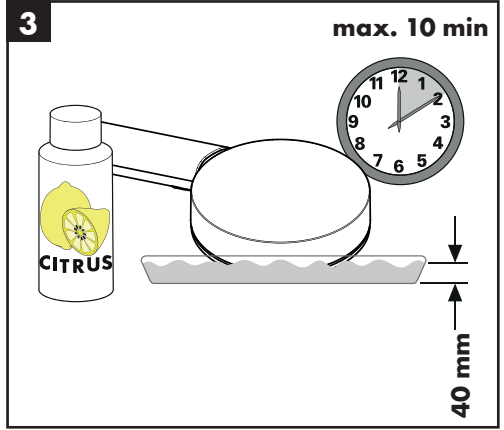
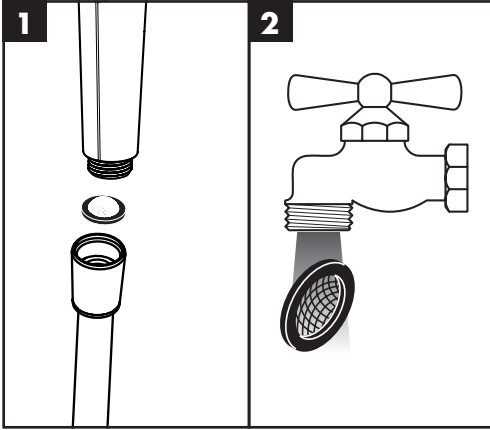

## Pulsify 105 3jet Activation

24101XX7

## Pulsify 105 3jet Relaxation

24111XX7

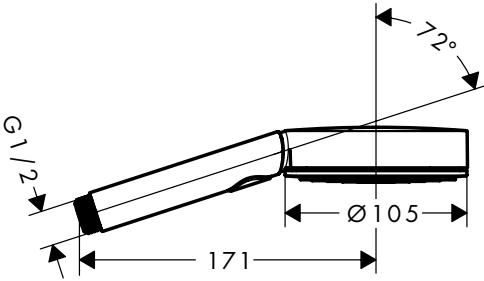

## Pulsify 105 1jet

24121XX7

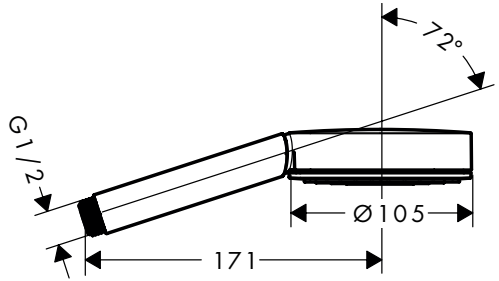

## Pulsify 105 3jet Activation

24101XX7

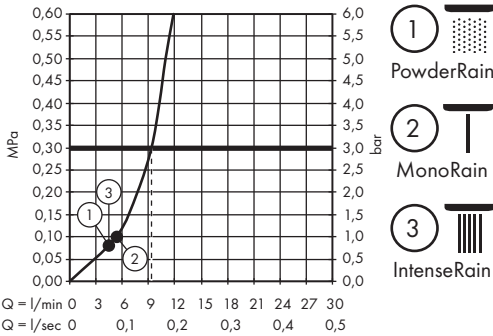

## Pulsify 105 3jet Relaxation

24111XX7

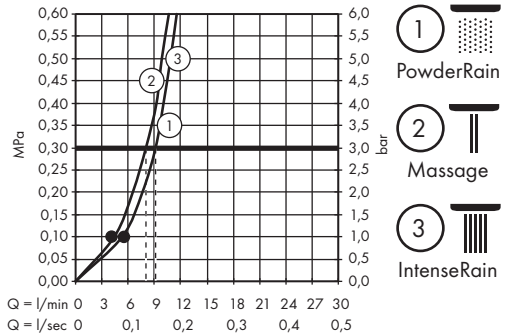

## Pulsify 105 1jet

24121XX7

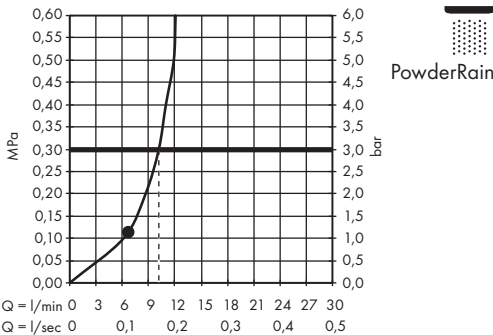

## 淋浴器水效等级

本公司淋浴器产品水效等级符合GB 28378-2019《淋浴器水效限定值及水效等级》的要求,淋浴器水效等级指标如下表:

## 流量

类型	1 级	2 级	3 级
手持式花洒	≤ 4.5	≤ 6.0	≤ 7.5
固定式花洒	≤ 4.5	≤ 6.0	≤ 9.0

(单位升每分)

(注:您所购买的产品的的水效等级以产品或包装物上标识的水效等级为准.)

## Water efficiency grades for showers





The water efficiency grades of Hansgrohe's showers meet the requirements of GB 28378-2019 "Minimum allowable values of water efficiency and water efficiency grades for showers". The indexes of water efficiency grades for showers are as follows:

## Flow rate

Type	Grade 1	Grade 2	Grade 3
Hand-held shower	≤ 4.5	≤ 6.0	≤ 7.5
Fixed shower head	≤ 4.5	≤ 6.0	≤ 9.0

(In L/min)

(Note: For the actual water efficiency grade of the purchased product, please refer to the water efficiency grade indicated on the product or package.)

	<b>P</b> max. 0,6 MPa 6 bar	<b>24101XX7</b> 0,11 - 0,4 MPa 1,1 - 4 bar	<b>24111XX7</b> 0,11 - 0,4 MPa 1,1 - 4 bar	<b>24121XX7</b> 0,11 - 0,4 MPa 1,1 - 4 bar	
	<b>T</b> max. 60 °C	< 50 °C			

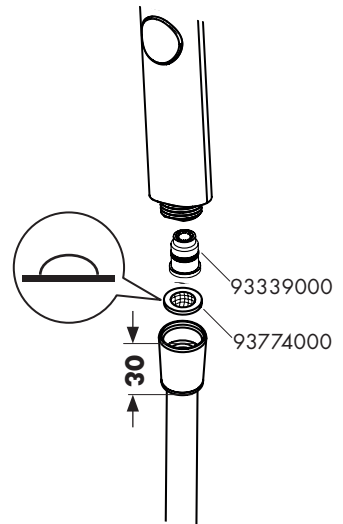
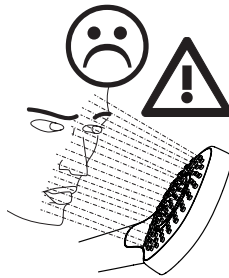
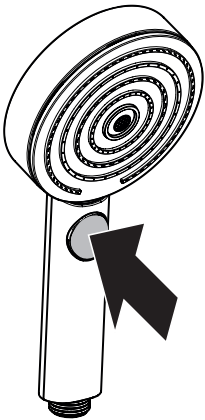

**hansgrohe**