

DE	Gebrauchsanleitung / Montageanleitung	2
FR	Mode d'emploi / Instructions de montage	3
EN	Instructions for use / assembly instructions	4
IT	Istruzioni per l'uso / Istruzioni per Installazione	5
ES	Modo de empleo / Instrucciones de montaje	6
NL	Gebruiksaanwijzing / Handleiding	7
DK	Brugsanvisning / Monteringsvejledning	8
PT	Instruções para uso / Manual de Instalação	9
PL	Instrukcja obsługi / Instrukcja montażu	10
CS	Návod k použití / Montážní návod	11
SK	Návod na použitie / Montážny návod	12
ZH	用户手册 / 组装说明	13
RU	Руководство пользователя / Инструкция по монтажу	14
HU	Használati útmutató / Szerelési útmutató	15
FI	Käyttöohje / Asennusohje	16
SV	Bruksanvisning / Monteringsanvisning	17
LT	Vartotojo instrukcija / Montavimo instrukcijos	18
HR	Upute za uporabu / Uputstva za instalaciju	19
TR	Kullanım kılavuzu / Montaj kılavuzu	20
RO	Manual de utilizare / Instrucțiuni de montare	21
EL	Οδηγίες χρήσης / Οδηγία συναρμολόγησης	22
SL	Navodilo za uporabo / Navodila za montažo	23
ET	Kasutusjuhend / Paigaldusjuhend	24
LV	Lietošanas pamācība / Montāžas instrukcija	25
SR	Uputstvo za upotrebu / Uputstvo za montažu	26
NO	Bruksanvisning / Montasjeveiledning	27
BG	Инструкция за употреба / Ръководство за монтаж	28
SQ	Udhëzuesi i përdorimit / Udhëzime rreth montimit	29
AR	دليل الاستخدام / تعليمات التجميع	30

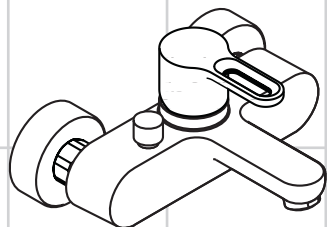

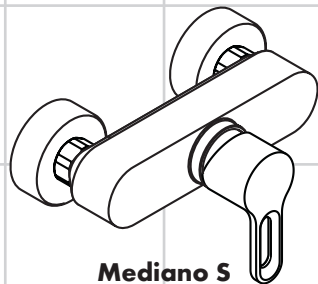

Mediano S
14432000



Mediano S
14632000



Sicherheitshinweise

-  Bei der Montage müssen zur Vermeidung von Quetsch- und Schnittverletzungen Handschuhe getragen werden.
-  Das Produkt darf nur zu Bade-, Hygiene- und Körperreinigungszwecken eingesetzt werden.
-  Große Druckunterschiede zwischen den Kalt- und Warmwasseranschlüssen müssen ausgeglichen werden.

Montagehinweise

- Die Armatur muss nach den gültigen Normen montiert, gespült und geprüft werden.
- Hansgrohe Armaturen können in Verbindung mit hydraulisch und thermisch gesteuerten Durchlauferhitzern eingesetzt werden, wenn der Fließdruck mindestens 0,15 MPa beträgt.

Technische Daten

Betriebsdruck:	max. 1 MPa
Empfohlener Betriebsdruck:	0,1 - 0,5 MPa
Prüfdruck:	1,6 MPa
(1 MPa = 10 bar = 147 PSI)	
Heißwassertemperatur:	max. 80 °C
Empfohlene Heißwassertemperatur:	65 °C
Anschlussmaße:	150 ± 12 mm
Anschlüsse G 1/2:	kalt rechts - warm links
Eigensicher gegen Rückfließen	

Symbolerklärung



Einhandmischer mit Warmwasserbegrenzung, Justierung siehe Seite 33. In Verbindung mit Durchlauferhitzern ist eine Warmwassersperre nicht notwendig.



Wartung (siehe Seite 37)

Rückflussverhinderer müssen gemäß DIN EN 1717 regelmäßig in Übereinstimmung mit nationalen oder regionalen Bestimmungen (DIN 1988 einmal jährlich) auf ihre Funktion geprüft werden.



Kein essigsäurehaltiges Silikon verwenden!



Maße (siehe Seite 34)



Durchflussdiagramm (siehe Seite 34)



Serviceteile (siehe Seite 35)



Bedienung (siehe Seite 36)



Reinigung (siehe beiliegende Broschüre)



Prüfzeichen (siehe Seite 40)



Störung	Ursache	Abhilfe
Wenig Wasser	- Siebdichtung der Brause verschmutzt - Rückflussverhinderer sitzt fest	- Siebdichtung zwischen Brause und Schlauch reinigen - Rückflussverhinderer austauschen
Armatur schwergängig	- Kartusche defekt, verkalkt	- Kartusche austauschen
Armatur tropft	- Kartusche defekt	- Kartusche austauschen
Zu niedere Warmwassertemperatur	- Warmwasserbegrenzung falsch eingestellt	- Warmwasserbegrenzung einstellen
Durchlauferhitzer schaltet nicht ein	- Drossel in der Handbrause nicht ausgebaut - Schmutzfangsiebe verschmutzt - Rückflussverhinderer sitzt fest	- Drossel aus der Handbrause entfernen - Schmutzfangsiebe reinigen / austauschen - Rückflussverhinderer austauschen



Montage siehe Seite 31



Consignes de sécurité

-  Lors du montage, porter des gants de protection pour éviter toute blessure par écrasement ou coupure.
-  Le système de douche ne doit servir qu'à se laver et à assurer l'hygiène corporelle.
-  Il est conseillé d'équilibrer les pressions de l'eau chaude et froide.

Instructions pour le montage

- La robinetterie doit être installée, rincée et contrôlée conformément aux normes valables.
- Les mitigeurs Hansgrohe fonctionnent également en association à des chauffe-eau à commande hydraulique ou thermique à condition que la pression soit au minimum de 0,15 MPa.

Informations techniques

Pression de service autorisée: max. 1 MPa
 Pression de service conseillée: 0,1 – 0,5 MPa
 Pression maximum de contrôle: 1,6 MPa
 (1 MPa = 10 bar = 147 PSI)
 Température d'eau chaude: max. 80 °C
 Température recommandée: 65 °C
 Dimension d'arrivée: 150 ± 12 mm
 Raccordement G 1/2: froide à droite - chaude à gauche
 Avec dispositif anti-retour

Description du symbole



Mitigeur avec limitation de la température: consulter la page 33 pour le réglage. Une limitation de la température n'est pas nécessaire quand le mitigeur est alimenté par un chauffe-eau instantané.



Entretien (voir page 37)

Les clapets anti-retour doivent être examinés régulièrement conformément à la norme EN 1717 ou conformément aux dispositions nationales ou régionales quant à leur fonction (au moins une fois par an).



Ne pas utiliser de silicone contenant de l'acide acétique!



Dimensions (voir page 34)



Diagramme du débit (voir page 34)



Pièces détachées (voir pages 35)



Instructions de service (voir page 36)



Nettoyage (voir la brochure ci-jointe)





Classification acoustique et débit (voir page 40)

Dysfonctionnement	Origine	Solution
Pas assez d'eau	- Joint-filtre de douchette encrassé	- Nettoyer le joint-filtre entre la douchette et le flexible
	- Clapet anti-retour bloque	- Changez le clapet antiretour
Dureté de fonctionnement	- Cartouche défectueuse, entartrée	- Changer le cartouche
Le mitigeur goutte	- Cartouche défectueuse	- Changer le cartouche
Température d'eau chaude trop basse, pas d'eau froide	- Limiteur de température mal positionné	- Positionner le limiteur de température
La chauffe-eau instantané ne s'allume pas	- Réducteur de débit non démonté	- Démontez le réducteur de débit de la douchette
	- Filtres encrassés	- Nettoyez / changez les filtres
	- Clapet anti-retour bloque	- Changez le clapet antiretour





Safety Notes

-  Gloves should be worn during installation to prevent crushing and cutting injuries.
-  The shower system may only be used for bathing, hygienic and body cleansing purposes.
-  The hot and cold supplies must be of equal pressures.

Installation Instructions

- The fitting must be installed, flushed and tested after the valid norms.
- Hansgrohe mixers can be used together with hydraulically and thermally controlled continuous flow heaters if the flow pressure is at least 0,15 MPa.

Technical Data

Operating pressure:	max. 1 MPa
Recommended operating pressure:	0,1 - 0,5 MPa
Test pressure:	1,6 MPa
(1 MPa = 10 bar = 147 PSI)	
Hot water temperature:	max. 80 °C
Recommended hot water temp.:	65 °C
Centre distance:	150 ±12 mm
Connections G 1/2:	cold right - hot left
anti-pollution function	

Symbol description



To adjust the hot water limiter on single lever mixers, please see page 33. No adjustment is necessary when using a continuous flow water heater.



Maintenance (see page 37)

The non return valves must be checked regularly according to DIN EN 1717 in accordance with national or regional regulations (at least once a year).



Do not use silicone containing acetic acid!



Dimensions (see page 34)



Flow diagram (see page 34)



Spare parts (see page 35)



Operation (see page 36)



Cleaning (see enclosed brochure)



Test certificate (see page 40)



Fault	Cause	Remedy
Insufficient water	- Shower filter seal dirty	- Clean filter seal between shower and hose
	- Non return valve hasn't moved back	- Exchange non return valves
Mixer stiff	- Cartridge defective, calcified	- Exchange cartridge
Mixer dripping	- Cartridge defective	- Exchange cartridge
Hot water temperature too low	- Hot water limiter incorrectly set	- Set hot water limiter
Instantaneous heater didn't work	- Flow limiter in handshower isn't removed	- Remove flow limiter
	- Filters are dirty	- Clean the filter / exchange filter
	- Non return valve hasn't moved back	- Exchange non return valves



Assembly see page 31



Indicazioni sulla sicurezza

-  Durante il montaggio, per evitare ferite da schiacciamento e da taglio bisogna indossare guanti protettivi.
-  Il sistema doccia deve essere utilizzato esclusivamente per l'igiene del corpo.
-  Attenzione! Compensare le differenze di pressione tra i collegamenti dell'acqua fredda e dell'acqua calda.

Istruzioni per il montaggio

- La rubinetteria deve essere installata, pulita e testata secondo le istruzioni riportate!
- I miscelatori Hansgrohe possono venire usati con caldaie a „bassa pressione“ se la pressione di flusso è almeno di 0,15 MPa.

Dati tecnici

Pressione d'uso:	max. 1 MPa
Pressione d'uso consigliata:	0,1 – 0,5 MPa
Pressione di prova:	1,6 MPa
(1 MPa = 10 bar = 147 PSI)	
Temperatura dell'acqua calda:	max. 80 °C
Temp. dell'acqua calda consigliata:	65 °C
Distanza di raccordo:	150 ± 12 mm
Raccordi G 1/2:	fredda a destra - calda a sinistra
Sicurezza antiriflusso	

Descrizione simbolo



Regolazione del limitatore di erogazione di acqua calda dei miscelatori monocomando, vedere pagina 33. In combinazione con le caldaie istantanee, il limitatore di erogazione di acqua calda non è necessario.



Manutenzione (vedi pagg. 37)

La valvola di non ritorno deve essere controllata regolarmente come da DIN EN 1717, secondo le normative nazionali e regionali (almeno una volta all'anno).



Non utilizzare silicone contenente acido acetico!



Ingombri (vedi pagg. 34)



Diagramma flusso (vedi pagg. 34)



Parti di ricambio (vedi pagg. 35)



Procedura (vedi pagg. 36)



Pulitura (vedi il prospetto accluso)



Segno di verifica (vedi pagg. 40)



Problema	Possibile causa	Rimedio
Scarsità d'acqua	- Guarnizione del filtro della doccia sporca	- Pulire la guarnizione del filtro tra doccia e flessibile
	- Valvola antiriflusso non funziona correttamente	- Sostituire la valvola antiriflusso
Miscelatore duro	- Cartuccia difettosa	- Sostituire la cartuccia
Miscelatore gocciola	- Cartuccia difettosa	- Sostituire la cartuccia
Temperatura dell'acqua calda	- Limitazione dell'acqua calda regolata male	- Regolare la limitazione dell'acqua calda
La caldaia istantanea non lavora	- Il limitatore di portata non è stato smontato dalla doccetta	- Smontare il limitatore di portata dalla doccetta
	- Filtri sporchi	- Pulire / sostituire i filtri
	- Valvola antiriflusso non funziona correttamente	- Sostituire la valvola antiriflusso



Montaggio vedi pagg. 31



Indicaciones de seguridad

-  Durante el montaje deben utilizarse guantes para evitar heridas por aplastamiento o corte.
-  La grifería solo debe ser utilizada para fines de baño, higiene y limpieza corporal.
-  Grandes diferencias de presión en servicio entre agua fría y agua caliente deben equilibrarse.

Indicaciones para el montaje

- El grifo tiene que ser instalado, probado y testado, según las normas en vigor.
- Los mezcladores Hansgrohe pueden ser utilizados junto con calentadores continuos de agua que sean manejados de manera hidráulica o térmica, siempre que la presión en servicio ascienda a un mínimo de 0,15 MPa.

Datos técnicos

Presión en servicio:	max. 1 MPa
Presión recomendada en servicio:	0,1 – 0,5 MPa
Presión de prueba:	1,6 MPa
(1 MPa = 10 bar = 147 PSI)	
Temperatura del agua caliente:	max. 80°C
Temp. recomendada del agua caliente:	65°C
Racores excéntricos:	150 ± 12 mm
Racores excéntricos G 1/2:	a la derecha frío - a la izquierda caliente
Seguro contra el retorno	

Descripción de símbolos



Uso como mezclador monomando con limitación del caudal de agua caliente: ver ajuste en página 33. En combinación con calentadores instantáneos no es necesario limitar el caudal de agua caliente.



Mantenimiento (ver página 37)

Las válvulas anti-retorno tienen que ser controladas regularmente según la norma DIN EN 1717, en acuerdo con las regulaciones nacionales o regionales (una vez al año, por lo menos).



No utilizar silicona que contiene ácido acético!



Dimensiones (ver página 34)



Diagrama de circulación (ver página 34)



Repuestos (ver página 35)



Manejo (ver página 36)



Limpiar (ver el folleto adjunto)





Marca de verificación (ver página 40)

Problema	Causa	Solución
Sale poca agua	- filtro de la ducha sucio	- limpiar/cambiar filtros entre flexo y ducha
	- válvula anti-retorno cerrada	- cambiar válvula anti-retorno
Manecilla va dura	- cartucho dañado	- cambiar el cartucho
Grifo pierde agua	- cartucho dañado	- cambiar el cartucho
temperatura del agua demasiado baja no hay	- tope de agua caliente mal	- ajustar tope
Calentador instantáneo no se enciende	- no se ha quitado limitador de caudal de la teleducha	- quitar limitador de caudal
	- filtro de la ducha sucio	- limpiar/cambiar filtros
	- válvula anti-retorno cerrada	- cambiar válvula anti-retorno





Veiligheidsinstructies

-  Bij de montage moeten ter voorkoming van knel- en snijwonden handschoenen worden gedragen.
-  Het douchesysteem mag alleen voor het wassen, hygiënische doeleinden en voor de lichaamreiniging worden gebruikt.
-  Grote drukverschillen tussen de kouden warm water-aansluitingen dienen vermeden te worden.

Montage-instructies

- Leidingen doorspoelen volgens Norm. De mengkraan vervolgens monteren en controleren.
- Hansgrohe kranen kunnen samen met hydraulisch en thermisch gestuurde geisers gebruikt worden indien de uitstroomdruk min. 0,15 MPa bedraagt.

Technische gegevens

Werkdruk: max.	max. 1 MPa
Aanbevolen werkdruk:	0,1 – 0,5 MPa
Getest bij:	1,6 MPa
(1 MPa = 10 bar = 147 PSI)	
Temperatuur warm water:	max. 80 °C
Aanbevolen warm water temp.:	65 °C
Aansluitmaten:	150 ± 12 mm
Aansluitingen G 1/2:	koud rechts - warm links
Beveiligd tegen terugstromen	

Symboolbeschrijving



Eéngreepsmengkranen met warmwaterbegrenzing, instelling zie blz. 33. In combinatie met geisers is een warmwaterbegrenzing niet noodzakelijk.



Onderhoud (zie blz. 37)

Keerklappen moeten volgens DIN EN 1717 regelmatig en volgens plaatselijk geldende eisen op het functioneren gecontroleerd worden. (Tenminste een keer per jaar).



Gebruik geen zuurhoudende silicone!



Maten (zie blz. 34)



Doorstroomdiagram (zie blz. 34)



Service onderdelen (zie blz. 35)



Bediening (zie blz. 36)



Reinigen (zie bijgevoegde brochure)



Keurmerk (zie blz. 40)

Storing	Oorzaak	Oplossing
Weinig water	- Zeefdichting handdouche verstopt - Terugslagklep zit vast	- Zeefdichting handdouche reinigen - Terugslagklep uitwisselen
Bediening zwaar	- Kardoes defect of verkalkt	- Kardoes uitwisselen
Mengkraan lekt	- Kardoes defect	- Kardoes uitwisselen
Temperatuur van warm water te laag	- Heetwaterbegrenzer verkeerd ingesteld	- Heetwaterbegrenzer instellen
Doorstroomtoestel schakelt niet in	- Begrenzer van handdouche niet verwijderd - Vuilzeef vverstopt - Terugslagklep zit vast	- Begrenzer uit handdouche verwijderen - Vuilvangzeef reinigen / uitwisselen - Terugslagklep uitwisselen





Sikkerhedsanvisninger

- △ Ved monteringen skal der bruges handsker for at undgå kvæstelser og snitsår.
- △ Brusersystemet må kun bruges til bade-, hygiejne og rengøringsformål.
- △ Større trykforskelte mellem koldt og varmt vand bør udjævnes.

Monteringsanvisninger

- Ifølge gældende regler, skal armaturet monteres, skylles igennem og afprøves.
- Hansgrohe armaturer kan anvendes i forbindelse med hydraulisk- og termiskstyrede gennemstrømningsvandvarmere ved et vandtryk på 0,15 MPa.

Tekniske data

Driftstryk:	max. 1 MPa
Anbefalet driftstryk:	0,1 - 0,5 MPa
Prøvetryk:	1,6 MPa
(1 MPa = 10 bar = 147 PSI)	
Varmvandstemperatur:	max. 80 °C
Anbefalet varmtvandstemperatur:	65 °C
Tilslutningsmål:	150 ± 12 mm
Tilslutninger G 1/2:	Koldt højre - varmt venstre
Med indbygget kontraventil	

Symbolbeskrivelse



Etgrebsarmaturer med varmtvandsbegrænsning, justering se side 33. I forbindelse med gennemstrømningsvandvarmer er en varmtvandsbegrænsning ikke nødvendig.



Service (se s. 37)

Ifølge DIN EN 1717 skal gennemstrømningsbegrænsere i overensstemmelse med nationale regler afprøves regelmæssigt (mindst en gang om året).



Der må ikke benyttes eddikesyreholdig silikone!



Målene (se s. 34)



Gennemstrømningsdiagram (se s. 34)



Reservedele (se s. 35)



Brugsanvisning (se s. 36)



Rengøring (se venligst den vedlagte brochure)





Godkendelse (se s. 40)

Fejl	Årsag	Hjælp
For lidt vand	- Sien mellem bruser og slange er snavset - Kontraventilen hænger	- Rengør sien mellem bruser og slange - Udskift kontraventil
Grebet går trægt	- Kartusche defekt, tilkalket	- Udskift kartusche
Armaturet drypper	- Defekt kartusche	- Udskift kartusche
For lav varmtvands-temperatur	- Varmtvandsbegrænsningen er forkert indstillet	- Indstil varmtvandsbegrænsningen
Vandvarmeren går ikke i gang	- Vandsparen i håndbruseren er ikke fjernet - Smudsfangsien er snavset - Kontraventilen hænger	- Afmonter vandsparen i håndbruseren - Rengør/udskift smudsfangsi - Udskift kontraventil





Avisos de segurança

-  Durante a montagem devem ser utilizadas luvas de protecção, de modo a evitar ferimentos resultantes de entalamentos e de cortes.
-  O sistema de duche só pode ser utilizado para fins de higiene pessoal.
-  Grandes diferenças entre as pressões das águas quente e fria devem ser compensadas.

Avisos de montagem

- A misturadora deve ser instalada, purgada e testada de acordo com as normas em vigor.
- As misturadoras Hansgrohe podem ser utilizadas com esquentadores (de controlo térmico ou hidráulico) desde que a pressão de utilização seja, no mínimo, de 0,15 MPa.

Dados Técnicos

Pressão de funcionamento:	max. 1 MPa
Pressão de func. recomendada:	0,1 – 0,5 MPa
Pressão testada:	1,6 MPa
(1 MPa = 10 bar = 147 PSI)	
Temperatura da água quente:	max. 80°C
Temp. água quente recomendada:	65°C
Distância entre eixos:	150 ±12 mm
Ligações G 1/2:	fria à direita - quente à esquerda
Função anti-retorno e anti-vácuo	

Descrição do símbolo



Misturadora monocomando equipada com limitador de temperatura (vide pàg. 33). Em combinação com caldeira ou esquentador instantâneo o limitador de água quente não se aplica.



Manutenção (ver página 37)

As válvulas anti-retorno devem ser verificadas regularmente de acordo com a DIN EN 1717 segundo os regulamentos nacionais ou regionais (pelo menos uma vez por ano).



Não utilizar silicone que contenha ácido acético!



Medidas (ver página 34)



Fluxograma (ver página 34)



Peças de substituição (ver página 35)



Funcionamento (ver página 36)



Limpeza (consultar a seguinte brochura)



Marca de controlo (ver página 40)

Falha	Causa	Solução
Água insuficiente	- Filtro do vedante do chuveiro sujo - Válvula anti-retorno está presa	- Limpar o filtro entre o chuveiro e o tubo flexível - Trocar a válvula anti-retorno
Misturadora perra	- Cartucho defeituoso, calcificado	- Substituir o cartucho
Misturadora a pingar	- Cartucho defeituoso	- Substituir o cartucho
Temperatura da água quente muito baixa	- O limitador de temperatura está incorrectamente colocado	- Regular o limitador de temperatura
O esquentador instantâneo não funciona	- O limitador de caudal não foi retirado - Filtro sujo - Válvula anti-retorno está presa	- Retirar o limitador de caudal - Limpar / trocar o filtro - Trocar a válvula anti-retorno





Wskazówki bezpieczeństwa

- △ Aby uniknąć zranień, takich jak zgniecenia czy przecięcia, podczas montażu należy nosić rękawice.
- △ Prysznic może być używany tylko do kąpieli, higieny i czyszczenia ciała.
- △ Znaczne różnice ciśnień na dopływach ciepłej i zimnej wody muszą zostać wyrównane.

Wskazówki montażowe

- Armatura musi być zamontowana, przepłukana i wypróbowana według obowiązujących norm.
- Armatura Hansgrohe może być stosowana z przepływowymi podgrzewaczami wody sterowanymi hydraulicznie i termicznie w przypadku, gdy ciśnienie przepływu wynosi co najmniej 0,15 MPa.

Dane techniczne

Ciśnienie robocze:	maks. 1 MPa
Zalecane ciśnienie robocze:	0,1 – 0,5 MPa
Ciśnienie próbne:	1,6 MPa
(1 MPa = 10 bary = 147 PSI)	
Temperatura wody gorącej:	maks. 80 °C
Zalecana temperatura wody gorącej:	65 °C
Wymiary przyłącza:	150 ± 12 mm
Przyłącza G 1/2:	Zimna prawo - ciepła lewo
Samoistnie zabezpieczony przed przepływem zwrotnym	

Opis symbolu



Mieszacz jednouchwytowy z ogranicznikiem temperatury wody, ustawianie, patrz str. 33. W połączeniu z przepływowym podgrzewaczem wody ogranicznik temperatury wody nie jest konieczny.



Konserwacja (patrz strona 37)

Działanie zabezpieczeń przed przepływem zwrotnym, zgodnie z normą DIN EN 1717 i miejscowymi przepisami, musi być kontrolowane (DIN 1988, raz w roku).



Nie stosować silikonów zawierających kwasy octowe!



Wymiary (patrz strona 34)



Schemat przepływu (patrz strona 34)



Części serwisowe (patrz strona 35)



Obsługa (patrz strona 36)



Czyszczenie (patrz dołączona broszura)



Znak jakości (patrz strona 40)



Usterka	Przyczyna	Pomoc
Mała ilość wody	- Zabrudzona uszczelka z sitkiem w prysznicy - Mocno osadzone zabezpieczenie przed przepływem zwrotnym	- Oczyszczyć uszczelkę z sitkiem pomiędzy prysznicem a węzem - Wymienić zabezpieczenie przed przepływem zwrotnym
Uchwyt armatury pracuje z wysiłkiem	- Uszkodzony wkład, zakamieniony	- Wymiana wkładu
Armatura cieknie	- Uszkodzony wkład	- Wymiana wkładu
Za niska temperatura ciepłej wody	- Niewłaściwe ustawienie ogranicznika ciepłej wody	- Ustawić ogranicznik ciepłej wody
Przepływowy podgrzewacz wody nie załącza się	- Dławik przepływu nie został usunięty z prysznica ręcznego - Zabrudzone sitka - Mocno osadzone zabezpieczenie przed przepływem zwrotnym	- Usunąć dławik z prysznica ręcznego - Oczyszczyć/ wymienić sitka - Wymienić zabezpieczenie przed przepływem zwrotnym



Montaż patrz strona 31



Bezpečnostní pokyny

-  Pro zabránění řezným zraněním a pohmožděninám je nutné při montáži nosit rukavice.
-  Produkt smí být používán pouze ke koupání a za účelem tělesné hygieny.
-  Je nutné vyrovnat velké rozdíly tlaku mezi přípoji studené a teplé vody.

Pokyny k montáži

- Armatura se musí montovat, proplachovat a testovat podle platných norem.
- Armatury Hansgrohe je možno používat v kombinaci s hydraulicky a tepelně řízenými průtokovými ohřívači v případě, že tlak činí minimálně 0,15 MPa.

Technické údaje

Provozní tlak:	max. 1 MPa
Doporučený provozní tlak:	0,1 – 0,5 MPa
Zkušební tlak:	1,6 MPa
(1 MPa = 10 bar = 147 PSI)	
Teplota horké vody:	max. 80 °C
Doporučená teplota horké vody:	65 °C
Rozteč připojení:	150 ± 12 mm
Přípoje G 1/2:	studená vpravo - teplá vlevo
Vlastní jištění proti zpětnému nasátí.	

Popis symbolů



Páková baterie s omezením horké vody, seřízení viz. str. 33. Ve spojení s průtokovými ohřívači není uzávěr teplé vody nutný.



Údržba (viz strana 37)

U zpětných ventilů se musí podle DIN EN 1717 v souladu s národními nebo regionálními předpisy testovat jejich funkčnost (alespoň jednou ročně).



Nepoužívat silikon s obsahem kyseliny octové!



Rozměry (viz strana 34)



Diagram průtoku (viz strana 34)



Servisní díly (viz strana 35)



Ovládání (viz strana 36)



Čištění (viz přiložená brožura)





Zkušební značka (viz strana 40)

Porucha	Příčina	Odstranění
Málo vody	- Sítko v těsnění u sprchy zanesené	- Vyčistit sítko v těsnění mezi sprchou a hadicí
	- zpětný ventil je zablokovaný	- Vyměnit zpětný ventil
Armatura jde ztěžka	- Kartuše je vadná, zanesená vodním kamenem	- Kartuši vyměnit
Armatura odkapává	- Kartuše je vadná	- Kartuši vyměnit
nízká teplota teplé vody	- Špatně nastavená zarážka pro teplou vodu	- Seřadit zarážku pro teplou vodu
Průtokový ohřívač nezapíná	- Není odstraněn kroužek ze sprchy	- Odstranit kroužek ze sprchy
	- Sítko na zachycování nečistot je zanesené	- Vyčistit případně vyměnit sítko
	- zpětný ventil je zablokovaný	- Vyměnit zpětný ventil





Bezpečnostné pokyny

-  Pri montáži musíte nosiť rukavice, aby ste predišli pomliaždeninám a rezným poraneniam.
-  Produkt sa smie používať len na kúpanie a telesnú hygienu.
-  Veľké rozdiely v tlaku medzi prípojkami studenej a teplej vody musia byť vyrovnané.

Pokyny pre montáž

- Armatúra sa musí montovať, preplachovať a testovať podľa platných noriem.
- Batérie Hansgrohe môžete používať v spojení s hydraulickými a tepelne ovládanými prietokovými ohrievačmi, ak je tlak minimálne 0,15 MPa.

Technické údaje

Prevádzkový tlak:	max. 1 MPa
Doporučený prevádzkový tlak:	0,1 - 0,5 MPa
Skúšobný tlak:	1,6 MPa
(1 MPa = 10 bar = 147 PSI)	
Teplota teplej vody:	max. 80 °C
Doporučená teplota teplej vody:	65 °C
Prípájacie rozmery:	150 ± 12 mm
Prípoje G 1/2:	studená vpravo - teplá vľavo
Vlastná poistka proti spätnému nasatiu.	

Popis symbolov



Páková batéria s obmedzením teplej vody, nastavenie vid' str. 33. V spojení s prietokovými ohrievačmi nie je uzáver teplej vody nutný.



Údržba (vid' strana 37)

Pri spätných ventiloch sa musí podľa DIN EN 1717 v súlade s národnými alebo regionálnymi predpismi testovať ich funkčnosť (aspoň raz ročne).



Nepoužívať silikón s obsahom kyseliny octovej!



Rozmery (vid' strana 34)



Diagram prietoku (vid' strana 34)



Servisné diely (vid' strana 35)



Obsluha (vid' strana 36)



Čistenie (nájdete v priloženej brožúre)



Osvedčenie o skúške (vid' strana 40)

Porucha	Príčina	Pomoc
Málo vody	- Sitko v tesnení sprchy je znečistené	- Vyčistiť sitko tesnení medzi sprchou a hadicou
	- Obmedzovač spätného nasatia je zablokovaný	- Vymeniť obmedzovač spätného nasatia
Armatúra "chodí" ťažko	- Kartuša je poškodená, vápenaté usadeniny	- Vymeniť kartušu
Armatúra pušča	- Kartuša je poškodená	- Vymeniť kartušu
Nízka teplota teplej vody	- Nesprávne nastavená zárážka na teplú vodu	- Nastavenie zárážky na teplú vodu
Prietokový ohrievač nezapína	- Nie je odstránený krúžok zo sprchy	- Odstrániť krúžok zo sprchy
	- Sitko v tesnení sprchy je znečistené	- Vyčistiť resp. vymeniť sitko
	- Obmedzovač spätného nasatia je zablokovaný	- Vymeniť obmedzovač spätného nasatia





安全技巧

- △ 装配时为避免挤压和切割受伤，必须戴上手套。
- △ 淋浴系统只允许作为洗浴、卫生和洁身之用。
- △ 冷热水管间过大的压力差必须予以平衡。

安装提示

- 必须按照现行的规定安装，冲洗和测试产品。
- 如果水压达到0,15 MPa以上，汉斯格雅双手柄龙头可以和液压式或热控式连续流热水器一起使用。

技术参数

工作压力:	最大 1 MPa
推荐工作压力:	0,1 0,5 MPa
测试压强:	1,6 MPa
(1 MPa = 10 bar = 147 PSI)	
热水温度:	最大 80° C
推荐热水温度:	65° C
中心距离:	150 ± 12 mm
连接管线G 1/2:	左热右冷
自动防止回流	

符号说明



带有热水控制器的单手柄龙头的调节方法，参见第 33 页。如果与连续流热水器一起使用，则不必作任何调节。



保养 (参见第 37 页)

单向阀必须在符合国家或当地的法律的情况下按照DIN EN 1717定期检查（至少一年一次）。



请勿使用含有乙酸的硅！



大小 (参见第 34 页)



流量示意图 (参见第 34 页)



备用零件 (参见第 35 页)



操作 (参见第 36 页)



清洗 (附有小手册)



检验标记 (参见第 40 页)



问题	原因	补救
龙头出水量小	-花洒滤网有垃圾堵塞 -单向阀无法回缩	-清洗花洒和软管间的过滤密封件 -更换单向阀
龙头不灵活	-滤筒损坏，结垢	-更换滤筒
龙头滴水	-滤筒损坏	-更换滤筒
热水温度过低	-热水控制器设置错误	-设置热水控制器
燃气热水器不工作	-手持花洒的流量限制器没有转动 -过滤网有垃圾堵塞 -单向阀无法回缩	-转动流量限制器 -清洗过滤网/更换过滤网 -更换单向阀



安装 参见第 31 页



Указания по технике безопасности

-  Во время монтажа следует надеть перчатки во избежание прищемления и порезов.
-  Изделие разрешается использовать только в гигиенических целях: для принятия ванны и личной гигиены.
-  донного клапа. Перед установкой смесителя необходимо регулировочными кранами выровнять давление холодной и горячей воды при помощи вентилей регулирующих подачу воды в квартиру.

Указания по монтажу

- Смеситель должен быть смонтирован по действующим нормам и в соответствии с настоящей инструкцией, проверен на герметичность и безупречность работы.
- Арматуры Hansgrohe могут использоваться в комбинации с проточными нагревателями с гидравлическим и термическим управлением, если давление истечения составляет не менее 0,15 МПа.

Технические данные

Рабочее давление:	не более. 1 МПа
Рекомендуемое рабочее давление:	0,1 – 0,5 МПа
Давление:	1,6 МПа
(1 МПа = 10 bar = 147 PSI)	
Температура горячей воды:	не более. 80 °С
Рекомендуемая темп. гор. воды:	65 °С
Размеры подключения:	150 ± 12 mm
Подключение G 1/2: холодная справа - горячая слева	
укомплектован клапаном обратного тока воды	

Описание символов



Однорычажный смеситель имеет ограничитель расхода горячей воды (см. Стр. 33: юстировка).



Техническое обслуживание
(см. стр. 37)

Защита обратного тока должна регулярно проверяться (минимум один раз в год) по стандарту DIN EN 1717 или в соответствии с национальными или региональными нормативами
Не применяйте силикон, содержащий уксусную кислоту.



Размеры (см. стр. 34)



Схема потока
(см. стр. 34)



Комплект (см. стр. 35)



Эксплуатация (см. стр. 36)



Очистка (см прилагаемая брошюра)





Знак технического контроля
(см. стр. 40)

Неисправность	Причина	Устранение неисправности
недостаточный давление (если устан напор воды)	- Фильтр душа загрязнен	- Очистить фильтр
	- Клапан обратного тока заедает	- Замените клапаны обратного течения
Арматура работает с усилием	- Картридж неисправен, засорение накилью	- Замените картридж
Арматура протекает	- Картридж неисправен	- Замените картридж
Температура горячей воды слишком низкая	- Ограничение горячей воды отрегулировано неправильно	- Отрегулируйте ограничение горячей воды
Проточный нагреватель не включается	- Дроссель не удален из ручного душа	- Извлеките дроссель из ручного душа
	- Грязеулавливающие сита загрязнены	- Очистите / замените грязеулавливающие сита
	- Клапан обратного тока заедает	- Замените клапаны обратного течения





Biztonsági utasítások

-  A szerelésnél a zúzódások és vágási sérülések elkerülése érdekében kesztyűt kell viselni.
-  A terméket csak fürdéshez, mosakodáshoz, és egészségügyi tisztálkodáshoz szabad használni.
-  A hidegvíz- és a melegvíz-csatlakozások közötti nagy nyomáskülönbséget kikell egyenlíteni!

Szerelési utasítások

- A csaptelepet az érvényben lévő előírásoknak megfelelően kell felszerelni, átöblíteni és ellenőrizni.
- A Hansgrohe csaptelepek hidraulikus és termikus vezérlésű átfolyós melegítőkkal kapcsolatban is használhatóak, ha az átfolyó nyomás legalább 0,15 MPa.

Műszaki adatok

Üzemi nyomás:	max. 1 MPa
Ajánlott üzemi nyomás:	0,1 – 0,5 MPa
Nyomáspróba:	1,6 MPa
(1 MPa = 10 bar = 147 PSI)	
Forróvíz hőmérséklet:	max. 80 °C
Forróvíz javasolt hőmérséklete:	65 °C
Csatlakozási méret:	150 ±12 mm
G 1/2 csatlakozás:	hideg jobbra – meleg balra
Visszafolyás gátlóval	

Szimbólumok leírása



Az egykaros, melegvíz-korlátozóval ellátott keverő csaptelep beállítását lásd a 33. oldalon. Az átfolyó rendszerű vízmelegítőknél nem szükséges a melegvíz-korlátozó.



Karbantartás (lásd a 37. oldalon)

A visszafolyásgátlók működése a DIN EN 1717 szabványnak megfelelően, a nemzeti vagy területi rendelkezésekkel összhangban, évente egyszer ellenőrizendő!



Ne használjon ecetsavtartalmú szilikon!



Méretet (lásd a 34. oldalon)



Átfolyási diagram (lásd a 34. oldalon)



Tartozékok (lásd a 35. oldalon)



Használat (lásd a 36. oldalon)



Tisztítás (lásd a mellékelt brosúrát)



Vizsgajel (lásd a 40. oldalon)

Hiba	Ok	Megoldás
Kevés víz	- a zuhany szűrőtömítése koszos	- a zuhany és a cső közötti szűrőt ki kell tisztítani
	- A visszafolyásgátló beragadt.	- A visszafolyásgátló kicserélése javasolt.
Nehezen nyitható a csap.	- A kerámiabetét meghibásodott, elvízkövesedett.	- A kerámiabetétet ki kell cserélni.
Csőpög a csap.	- A kerámiabetét meghibásodott.	- A kerámiabetétet ki kell cserélni.
túl alacsony melegvíz hőmérséklet	- A melegvíz szabályozó rosszul van beállítva.	- A melegvíz szabályozót újra be kell állítani.
Az átfolyós vízmelegítő nem kapcsol be.	- Nincs kiszerve a zuhanyrózsából a vízmennyiség szabályozó.	- El kell távolítani a vízmennyiség szabályozót.
	- A szennyfogó szűrő koszos.	- A szennyfogó szűrőt tisztítani/cserélni kell.
	- A visszafolyásgátló beragadt.	- A visszafolyásgátló kicserélése javasolt.



Szerelés lásd a 31. oldalon



Turvallisuusohjeet

- △ Asennuksessa on käytettävä käsineitä puristumien ja viiltojen aiheuttamien tapaturmien estämiseksi.
- △ Suihkujärjestelmää saa käyttää ainoastaan kylpy-, hygienia- ja puhdistustarkoituksiin.
- △ Suuret paine-erot kylmä- ja kuumavesiliitäntöjen välillä on tasattava.

Asennusohjeet

- Kaluste on asennettava, huuhdeltava ja tarkastettava voimassa olevien määräysten mukaisesti.
- Hansgrohe kalusteita voi käyttää hydraulisesti tai termisesti ohjattujen läpivirtauskuumentimien yhteydessä, jos virtauspaine on vähintään 0,15 MPa.

Tekniset tiedot

Käyttöpaine:	maks. 1 MPa
Suosittelut käyttöpaine:	0,1 - 0,5 MPa
Koestuspaine:	1,6 MPa
(1 MPa = 10 bar = 147 PSI)	
Kuuman veden lämpötila:	maks. 80 °C
Kuuman veden suosituslämpötila:	65 °C
Liitäntämitat:	150 ±12 mm
Liittimet G 1/2:	kylmä oikealla - kuuma vasemmallä
Estää itsestään paluuvirtauksen	

Merkin kuvaus



Yksivipuinen sekoittaja lämpimän veden rajoituksella, katso säätö sivulta 33. Lämpimän veden rajoitusta ei tarvita läpivirtauskuumentimen yhteydessä.



Huolto (katso sivu 37)

Vastaventtiilin toiminta on tarkastettava säännöllisesti paikallisten ja kansallisten määräysten mukaisesti (DIN 1988, kerran vuodessa).



Älä käytä etikahappopitoista silikoniala!



Mitat (katso sivu 34)



Virtausdiagrammi (katso sivu 34)



Varaosat (katso sivu 35)



Käyttö (katso sivu 36)



Puhdistus (katso oheinen esite)



Koestusmerkki (katso sivu 40)

Häiriö	Syy	Toimenpide
Vähän vettä	- Käsिसuihkun sihtitiiviste likaantunut - Suuntaisventtiili juuttunut	- Puhdista suihkukahvan ja letkun välissä oleva sihtitiiviste - Vaihda suuntaisventtiili
Hana on raskaskäyttöinen	- Patruuna rikki, kalkkikerrostumia	- Vaihda patruuna
Hanasta tippuu vettä	- Patruuna rikki	- Vaihda patruuna
Lämminveden lämpötila liian alhainen	- Lämminveden rajoitin väärin säädetty	- Säädä lämminveden rajoitin
Läpimenokuumennin ei kytkeydy päälle	- Käsिसuihkussa olevaa kuristinta ei ole poistettu - Likasihdit likaantuneet - Suuntaisventtiili juuttunut	- Poista kuristin käsिसuihkusta - Puhdista / vaihda likasihdit - Vaihda suuntaisventtiili





Säkerhetsanvisningar

- △ Handskar ska bäras under monteringsarbetet så att man kan undvika kläm- och skärskadorgen werden.
- △ Produkten får bara användas till kroppshygien med bad och dusch.
- △ Stora tryckskillnader mellan anslutningarna för varmt och kallt vatten måste utjämnas.

Monteringsanvisningar

- Armaturen måste installeras, genomspolas och testas enligt gällande föreskrifter.
- Hansgrohe blandare kan användas tillsammans med hydrauliskt och termiskt styrda varmvattenberedare när flödestrycket uppgår till minst 0,15 MPa.

Tekniska data

Driftstryck:	max. 1 MPa
Rek. driftstryck:	0,1 - 0,5 MPa
Tryck vid provtryckning:	1,6 MPa
(1 MPa = 10 bar = 147 PSI)	
Varmvattentemperatur:	max. 80 °C
Rek. varmvattentemp.:	65 °C
Anslutningsmått:	150 ±12 mm
Anslutningar G 1/2:	kallt höger - varmt vänster
Självspärr mot återflöde	

Simbolio aprašymas



Enhandsblandare med varmvattenreglering, justering se sidan 33. Vid användning tillsammans med varmvattenberedare behövs ingen varmvattenreglering.



Skötsel (se sidan 37)

Backventilens funktion måste kontrolleras regelbundet enligt nationella eller regionala bestämmelser (DIN 1988 en gång per år) i enlighet med DIN EN 1717.



Använd inte silikon som innehåller ättiksyra!



Måtten (se sidan 34)



Pralaidumo diagrama (se sidan 34)



Reservdelar (se sidan 35)



Hantering (se sidan 36)



Rengöring (se den medföljande broschyren)





Testsigill (se sidan 40)

Störning	Orsak	Åtgärd
För lite vatten	- Silfiltret i duschen smutsigt - Backventil är defekt	- Rengör silfiltret mellan slangen och termostaten - Byt backventil
Blandare är trög	- Patron defekt, förkalkad	- Byt ut patron
Blandare droppar	- Patron defekt	- Byt ut patron
Varmvattentemperaturen är för låg	- Varmvattenreglering felaktigt inställd	- Ställ in varmvattenreglering
Varmvattenberedare slår ej på	- Vattenbegränsare i handduschen har ej tagits bort - Smutsfiltren är igensmutsade - Backventil är defekt	- Ta bort vattenbegränsaren - Rengör / byt smutsfilter - Byt backventil





Saugumo technikos nurodymai

-  Apsaugai nuo užspaudimo ir įsijovimo montavimo metu mūvėkite pirštines.
-  Gaminy s turi būti naudojamas tik maudymuisi, kūno higienai ir švarai palaikyti.
-  Turi būti išlyginti šalto ir karšto slėgio nelygumai.

Montavimo instrukcija

- Maišytuvą privalo būti montuojamas ir išbandomas pagal veikiančias normas ir šią instrukciją.
- „Hansgrohe“ maišytuvai gali būti naudojami su hidrauliškai ir termiškai reguliuojamais momentiniais šildikliais, kai vandens slėgis mažesnis kaip 0,15 MPa.

Techniniai duomenys

Darbinis slėgis: ne daugiau kaip 1 MPa
 Rekomenduojamas slėgis: 0,1 – 0,5 MPa
 Bandomasis slėgis: 1,6 MPa
 (1 MPa = 10 barų = 147 PSI)

Karšto vandens temperatūra: ne daugiau kaip 80 °C
 Rekomenduojama karšto vandens temperatūra: 65 °C
 Atstumas tarp centrų: 150 ± 12 mm
 Prijungimas G 1/2: Šaltas vanduo dešinėje,
 karštas - kairėje
 Su atbuliniu vožtuvu

Simbolio aprašymas



Vienos rankenėlės maišytuvą turi karšto vandens ribotuvą (nustatymą žr. psl. 33). Naudojant momentinį šildiklį karšto vandens ribotuvą nebūtina.



Techninis aptarnavimas (žr. psl. 37)

Atbulinio vožtuvo apsauga privalo būti tikrinama reguliariai (mažiausiai kartą per metus pagal DIN 1988) pagal DIN EN 1717 arba pagal galiojančias nacionalines arba regionines normas. Nenaudokite silikono, kurio sudėtyje yra acto rūgšties!



Išmatavimai (žr. psl. 34)



Pralaidumo diagrama (žr. psl. 34)



Atsarginės dalys (žr. psl. 35)



Eksplotacija (žr. psl. 36)



Valymas (žr. pridedamoje brošiūroje)



Bandymo pažyma (žr. psl. 40)





Gedimas	Priežastis	Priemonė
Per maža srovė	- Dušo galvos filtras užsikimšęs - Abulinis vožtuvas neveikia	- Išvalyti dušo galvos filtrą - Pakeisti atbulinį vožtuvą
Sunkiai sukiojama rankenėlė	- Kasetė pažeista, užkalkėjusi	- Pakeisti kasetę
Maišytuvą praleidžia vandenį	- Kasetė pažeista	- Pakeisti kasetę
Per maža karšto vandens temperatūra	- Neteisingai nustatytas karšto vandens ribotuvą	- Nustatyti karšto vandens ribotuvą
Momentinis pašildytojas neįsijungia	- Neišimtas ribotuvą iš dušo galvutės - Užsikimšęs filtras - Abulinis vožtuvas neveikia	- Išimti ribotuvą iš dušo galvutės - Išvalyti / pakeisti filtrą - Pakeisti atbulinį vožtuvą





Sigurnosne upute

-  Prilikom montaže se radi sprječavanja prignječenja i posjekotina moraju nositi rukavice.
-  Proizvod se smije primjenjivati samo za kupanje, tuširanje i osobnu higijenu.
-  Velika razlika u pritisku između vruće i hladne vode mora biti izbalansirana.

Upute za montažu

- Cijevi moraju biti postavljene, isprane i testirane prema važećim normama.
- Hansgrohe armature mogu se koristiti u kombinaciji sa hidraulički i termički kontroliranim protočnim bojlerima ukoliko tlak iznosi najmanje 0,15 MPa

Tehnički podaci

Najveći dopušteni tlak:	tlak 1 MPa
Preporučeni tlak:	0,1 – 0,5 MPa
Probni tlak:	1,6 MPa
(1 MPa = 10 bar = 147 PSI)	
Temperatura vruće vode:	tlak 80 °C
Preporučena temperatura vruće vode:	65 °C
Razmak od sredine:	150 ± 12 mm
Spojevi G 1/2:	hladna desno – topla lijevo
Funkcije samo-čišćenja	

Opis simbola



Da bi podesili limiter vruće vode na jednoručnim slavinama molimo Vas da pogledate stranicu 33. Podešavanje nije potrebno ako koristite protočni bojler.



Održavanje (pogledaj stranicu 37)

Ispravnost nepovratnog ventila mora se redovito provjeravati prema standardu DIN EN 1717 i u skladu sa važećim propisima (najmanje jednom godišnje).



Nemojte koristiti silikon koji sadrži octenu kiselinu!



Mjere (pogledaj stranicu 34)



Dijagram protoka (pogledaj stranicu 34)



Rezervni djelovi (pogledaj stranicu 35)



Upotreba (pogledaj stranicu 36)



Čišćenje (se u priloženoj brošuri)



Oznaka testiranja (pogledaj stranicu 40)

Greška	Uzrok	Otklanjanje
Nedovoljno vode	- Filter tuša je prljav - Nepovratni ventil se nije vratio u početni položaj	- Očistite filter između tuša i crijeva - Zamijenite nepovratni ventil
Ručica se zaglavila	- Neispravan uložak Taloženje kamenca	- Zamijenite uložak
Slavina kaplje	- Neispravan uložak	- Zamijenite uložak
Preiska temperatura tople vode	- Limiter vruće vode nije dobro podešen	- Podesite limiter vruće vode
Protočni bojler ne radi	- Limiter protoka u ručnom tušu nije odstranjen - Filtri su prljavi - Nepovratni ventil se nije vratio u početni položaj	- Odstranite limiter protoka - Očistite ili zamijenite filter - Zamijenite nepovratni ventil



Sastavljanje pogledaj stranicu 31



! Güvenlik uyarıları

- Montaj esnasında ezilme ve kesilme gibi yaralanmaları önlemek için eldiven kullanılmalıdır.
- Duş sistemi yalnızca banyo, hijyen ve beden temizliği amaçları doğrultusunda kullanılabilir.
- Sıcak ve soğuk su bağlantıları arasında büyük basınç farklılıkları varsa, bu basınç farklılıklarının dengelenmesi gerekir.

Montaj açıklamaları

- Batarya monte edilmeli, geçerli normlardan sonra akis testi yapılmalıdır.
- Hansgrohe bataryaları, akış basıncı en az 0,15 MPa olursa hidrolik ve termik kumandalı şofbenlerle bağlantılı olarak kullanılabilir.

Teknik bilgiler

İşletme basıncı:	azami 1 MPa
Tavsiye edilen işletme basıncı:	0,1 – 0,5 MPa
Kontrol basıncı:	1,6 MPa
(1 MPa = 10 bar = 147 PSI)	
Sıcak su sıcaklığı:	azami 80 °C
Tavsiye edilen su ısıtı:	65 °C
Bağlantı ölçüleri:	150 ±12 mm
G 1/2 bağlantılar:	soğuk sağ - sıcak sol
Gerilme önleyici	

Simge açıklaması



Sıcak su sınırlayıcı özelliğine sahip tek kollu bataryanın ayarlanması için 33. sayfaya bakınız. Bir sürekli akışlı su ısıtıcısı ile birlikte kullanılırsa sıcak su sınırlayıcısına gerek kalmaz.



Bakım (Bakınız sayfa 37)

DIN EN 1717 ve ulusal standartlar doğrultusunda Çek valfler düzenli olarak kontrol edilmelidir. (en az yılda bir kez)



Asetik asit içeren silikon kullanmayın!



Ölçüleri (Bakınız sayfa 34)



Akış diyagramı (Bakınız sayfa 34)



Yedek Parçalar (Bakınız sayfa 35)



Kullanımı (Bakınız sayfa 36)



Temizleme (birlikte verilen broşür)





Kontrol işareti (Bakınız sayfa 40)

arıza	sebebi	yardımi
Az su geliyor	- Duşun süzgeci tıkanmış olabilir	- El duşu ile hortum arasındaki hortumu yıkayın
	- Çek valf çalışmıyor olabilir	- Çek valfi değiştirin
Batarya kullanımı ağırlaşiyor	- Kartuş Bozulmuş ve kireçlenmiş olabilir	- Kartuşu değiştirin
Batarya su damlatıyor	- Kartuş bozuk olabilir	- Kartuşu değiştirin
Sıcak suyun derecesi çok düşük	- Isı limitleyici düzgün çalışmıyor	- Isı limitleyiciyi yeniden ayarlayın
Şofben çalışmıyor	- El duşunun içindeki akım limitleyici çıkartılmamış olabilir	- Akım limitleyiciyi el duşundan çıkartın
	- Filtre tıkanmış olabilir	- Filtreyi temizleyin yada çıkartın
	- Çek valf çalışmıyor olabilir	- Çek valfi değiştirin





Instrucțiuni de siguranță

-  La montare utilizați mănuși pentru evitarea contuziunilor și tăierii mâinilor.
-  Sistemul de duș poate fi utilizat doar pentru spălarea, menținerea igienei și curățarea corpului.
-  Diferențele de presiune mari între alimentarea cu apă rece și apă caldă trebuie echilibrate.

Instrucțiuni de montare

- Bateria trebuie montată, clătită și verificată conform normelor în vigoare.
- Bateriile Hansgrohe pot fi utilizate cu boiler instant cu comandă termică sau hidraulică dacă presiunea apei de alimentare este de min. 0,15 MPa.

Date tehnice

Presiune de funcționare:	max. 1 MPa
Presiune de funcționare recomandată:	0,1 - 0,5 MPa
Presiune de verificare:	1,6 MPa
(1 MPa = 10 bar = 147 PSI)	
Temperatura apei calde:	max. 80 °C
Temperatura recomandată a apei calde:	65 °C
Interax racorduri:	150 ± 12 mm
Racorduri G 1/2 :	rece - dreapta / cald - stânga
Asigurat contra scurgeri înapoi	

Descrierea simbolurilor



Bateria monocomadă cu limitarea apei calde, pentru reglare vezi pag. 33. Dacă conectați bateria la un boiler instant nu este necesară instalarea unui opritor de apă caldă.



Întreținere (vezi pag. 37)

Supapele de reținere trebuie verificate regulat conform DIN EN 1717 și standardele naționale sau regionale (anual conform DIN 1988).



Nu utilizați silicon cu conținut de acid acetic!



Dimensiuni (vezi pag. 34)



Diagrama de debit
(vezi pag. 34)



Piese de schimb (vezi pag. 35)



Utilizare (vezi pag. 36)



Curățare (vezi broșura alăturată)



Certificat de testare (vezi pag. 40)



Deranjament	Cauza	Măsurile de remediere
Prea puțină apă	- S-a murdărit garnitura de sită a capătului de duș. - S-a blocat supapa antiretur.	- Curățați garnitura sită dintre capătul duș și furtun. - Schimbați supapa antiretur.
Bateria se mișcă dificil	- Cartuș defect din cauza depunerilor de calcar	- Schimbați cartușul.
Bateria picură	- Cartuș defect	- Schimbați cartușul.
Temperatura apei calde este prea mică	- Limitarea temperaturii apei calde setată incorect.	- Setajii limitarea temperaturii apei calde.
Boilerul instant nu funcționează.	- Reductorul nu a fost demontat din dușul de mână. - Sitele de impurități murdare. - S-a blocat supapa antiretur.	- Îndepărtați reductorul din dușul de mână. - Curățați / schimbați sitele de impurități. - Schimbați supapa antiretur.



Montare vezi pag. 31



Υποδειξεις ασφαλείας

-  Για να αποφύγετε τραυματισμούς κατά τη συναρμολόγηση πρέπει να φοράτε γάντια.
-  Το προϊόν επιτρέπεται να χρησιμοποιείται μόνο σαν μέσο λουτρού, υγιεινής και καθαρισμού του σώματος.
-  Οι διαφορές της πίεσης μεταξύ της σύνδεσης κρύου και ζεστού νερού θα πρέπει να αντισταθμίζονται.

Οδηγίες συναρμολόγησης

- Η μπαταρία πρέπει να τοποθετηθεί, να πλυθεί και να ελεγχθεί με βάση τους ισχύοντες κανόνες υδραυλικής τέχνης
- Οι βάνες Hansgrohe μπορούν να συνδυαστούν με ταχυθερμοσίφωνες υδραυλικού και θερμικού ελέγχου, όταν η πίεση ροής αριθμεί τουλάχιστον 0,15 MPa.

Τεχνικά Χαρακτηριστικά

Λειτουργία πίεσης:	έως 1 MPa
Συνιστώμενη λειτουργία πίεσης:	0,1 – 0,5 MPa
Πίεση ελέγχου:	1,6 MPa
(1 MPa = 10 bar = 147 PSI)	
Θερμοκρασία ζεστού νερού:	έως 80 °C
Συνιστώμενη θερμοκρασία ζεστού νερού:	65 °C
Διαστάσεις σύνδεσης:	150 ± 12 mm
Συνδέσεις G 1/2:	κρύο δεξιά – ζεστό αριστερά
Περιλαμβάνει βαλβίδα αντεπιστροφής.	

Περιγραφή συμβόλων



Για να προσαρμόσετε το δοσομετρική ζεστού νερού σε αναμεικτικές μπαταρίες, παρακαλούμε δείτε τη ρύθμιση στη σελ. 33. Δεν είναι απαραίτητη η διάταξη φραγής ζεστού νερού σε συνδυασμό με ταχυθερμοσίφωνα.



Συντήρηση (βλ. σελίδα 37)

Οι βαλβίδες αντεπιστροφής πρέπει να ελέγχονται τακτικά ως προς τη λειτουργία τους, σύμφωνα με τις οδηγίες DIN EN 1717, σε σχέση με τους ισχύοντες εθνικούς ή τοπικούς κανόνες (το ελάχιστο μια φορά το χρόνο, σύμφωνα με το πρότυπο DIN 1988) Μην χρησιμοποιείτε σιλικόνη που περιέχει οξικό οξύ!



Διαστάσεις (βλ. σελίδα 34)



Διάγραμμα ροής (βλ. σελίδα 34)



Ανταλλακτικά (βλ. σελίδα 35)



Χειρισμός (βλ. σελίδα 36)



Καθαρισμός (βλ. συνημμένο φυλλάδιο)



Σήμα ελέγχου (βλ. σελίδα 40)





Βλάβη	Αιτία	Διόρθωση
Ανεπαρκές νερό	- Βρώμικη στεγανοποιητική σήτα του καταιονιστήρα - Η βαλβίδα αντεπιστροφής δεν γυρίζει πίσω.	- Καθαρίστε και, εάν χρειαστεί, αλλάξτε τη στεγανοποιητική σήτα μεταξύ καταιονιστήρα και σπιρράλ - Αλλάξτε τη βαλβίδα αντεπιστροφής
Σκληρή μπαταρία (μείκτης)	- Ελαττωματικό φυσιγγίο, άλατα	- Αλλαγή φυσιγγίου
Η μπαταρία στάζει	- Ελαττωματικό φυσιγγίο	- Αλλαγή φυσιγγίου
Χαμηλή θερμοκρασία ζεστού νερού	- Λάθος ρύθμιση της περιοριστικής διάταξης ζεστού νερού	- Ρυθμίστε την περιοριστική διάταξη του ζεστού νερού
Ο ταχυθερμοσίφωνα δεν ενεργοποιείται	- Το στραγγαλιστικό πηνίο δεν έχει αποσυναρμολογηθεί από τον καταιονιστήρα χειρός - Τα φίλτρα συλλογής ακαθαρσιών είναι λερωμένα - νάλνula anti-retorno cerrada	- Καθαρίστε το στραγγαλιστικό πηνίο από τον καταιονιστήρα χειρός - Καθαρίστε/αλλάξτε το φίλτρο συλλογής ακαθαρσιών - Αλλάξτε τη βαλβίδα αντεπιστροφής



Συναρμολόγηση βλ. σελίδα 31



Varnostna opozorila

-  Pri montaži je treba nositi rokavice, da se preprečijo poškodbe zaradi zmečkanja ali urezov.
-  Ta izdelek se sme uporabljati le z namenom umivanja, vzdrževanja higiene in telesne nege.
-  Velike razlike v tlaku med priključkom za mrzlo in priključkom za toplo vodo je potrebno izravnati.

Instructions pour le montage

- Armatura je potrebno montirati, splakniti in testirati v skladu z veljavnimi predpisi.
- Armature Hansgrohe lahko uporabljate v povezavi s hidravlično in termično uravnanimi pretočnimi grelniki, če je pretočni tlak najmanj 0,15 MPa.

Tehnični podatki

Delovni tlak:	maks. 1 MPa
Priporočeni delovni tlak:	0,1 – 0,5 MPa
Preskusni tlak:	1,6 MPa
(1 MPa = 10 bar = 147 PSI)	
Temperatura tople vode:	maks. 80 °C
Priporočena temperatura tople vode:	65 °C
Razdalja od sredine:	150 ± 12 mm
Priključki G 1/2:	mrzla desno - topla levo
Zaščita proti povratnemu toku	

Opis simbola



Enoročne mešalne baterije z omejevalnikom tople vode, za justiranje glejte stran 33. V povezavi s pretočnimi grelniki zapora tople vode ni potrebna.



Vzdrževanje (glejte stran 37)

Delovanje protipovratnega ventila je potrebno v skladu z DIN EN 1717 in skladno z državnimi in regionalnimi določili (DIN 1988 enkrat letno) redno testirati.



Ne smete uporabiti silikona, ki vsebuje očetno kislino!



Mere (glejte stran 34)



Diagram pretoka (glejte stran 34)



Rezervni deli (glejte stran 35)



Upravljanje (glejte stran 36)



Čiščenje (glejte priloženi brošuri)





Preskusni znak (glejte stran 40)

Napaka	Vzrok	Pomoč
Malo vode	- Filtrirna mrežica prhe je umazana - Protipovratni ventil je obtičal	- Očistite filtrirno mrežico med prho in gibko cevjo - Zamenjajte protipovratni ventil
Težko premikanje armature	- Pokvarjen vložek, poapneno	- Zamenjajte vložek
Iz armature kaplja	- Pokvarjen vložek	- Zamenjajte vložek
Prenizka temperatura tople vode	- Omejevalnik tople vode ni pravilno nastavljen	- Nastavite omejevalnik tople vode
Pretočni grelnik se ne vklopi	- Omejevalnik pretoka ni odstranjen iz ročne prhe - Filtri so umazani - Protipovratni ventil je obtičal	- Odstranite omejevalnik pretoka iz ročne prhe - Očistite/zamenjajte filtre - Zamenjajte protipovratni ventil





Ohutusjuhised

-  Kandke paigaldamisel muljumis- ja löikevigastuste vältimiseks kindaid.
-  Toodet tohib kasutada ainult pesemis-, hügieeni- ja kehapuhastamisesmärkidel.
-  Kui külma ja kuuma vee ühenduste surve on väga erinev, tuleb need tasakaalustada.

Paigaldamisjuhised

- Seadmestiku paigaldamine, läbipesu ja kontrollimine peab toimuma vastavalt kehtivatele normidele.
- Hansgrohe segisteid võib kasutada koos hüdrauliliselt ja termiliselt juhitavate boileritega, kui vee surve on vähemalt 0,15 MPa.

Tehnilised andmed

Töörõhk	maks. 1 MPa
Soovitatav töörõhk:	0,1 – 0,5 MPa
Kontrollsurve:	1,6 MPa
(1 MPa = 10 baari = 147 PSI)	
Kuuma vee temperatuur:	maks. 80 °C
Soovitatav kuuma vee temperatuur:	65 °C
distanti keskel:	150 ± 12 mm
ühendused G 1/2:	külm paremal, kuum vasakul
tagasivooluklapp	

Sümbolite kirjeldus



Ühe juhtkangiga segisti kuuma vee piiraja reguleerimise kohta vt lk 33. Läbivoolu boilerite puhul pole reguleerimine vajalik.



Hoolitus (vt lk 37)

Tagasilöögiklappide toimimist tuleb kooskõlas riiklike ja regionaalsete määrustega regulaarselt kontrollida vastavalt standardile DIN EN 1717 (DIN 1988 - kord aastas).



Ärge kasutage äädikhapet sisaldavat silikooni!



Mõõtude (vt lk 34)



Läbivooludiagramm (vt lk 34)



Varuosad (vt lk 35)



Kasutamine (vt lk 36)



Puhastamine (vt kaasasolevast brošüürist)





Kontrollsertifikaat (vt lk 40)

Rike	Põhjus	Lahendus
Vähe vett	- Duši sõelalihend must - Tagasilöögiklapp on kinni	- Puhastage duši ja vooliku vaheline sõelalihend - Tagasilöögiklapp välja vahetada
Segisti käib raskelt	- Tööelement on katkine, lubjastunud	- Vahetage tööelement
Segisti tilgub	- Tööelement on katkine	- Zamenjajte vložek
Sooja vee temperatuur liiga madal	- Kuuma vee piirang valesti seatud	- Seadke kuuma vee piirang
avatud süsteemi boiler ei lülitu sisse	- Veehulga piirajat ei ole ära võetud - Filtrid määrdunud - Tagasilöögiklapp on kinni	- Eemaldage veehulga piiraja - Puhastage/vahetage filter - Tagasilöögiklapp välja vahetada





Drošības norādes

-  Montāžas laikā, lai izvairītos no saspiedumiem un iegriezumiem, nepieciešams nēsāt cimdus.
-  Šo produktu drīkst izmantot tikai, lai mazgātos, higiēnai un ķermeņa tīrīšanai.
-  Jāizlīdzina spiediena atšķirības starp aukstā un karstā ūdens pievadiem.

Norādījumi montāžai

- Jaucējkrāns jāmontē, jāskalo un jāpārbauda atbilstoši spēkā esošajām normām.
- Hansgrohe jaucējkrānus var izmantot kombinācijā ar hidrauliski un termiski vadāmiem caurteces sildītājiem, ja plūsmas spiediens ir vismaz 0,15 MPa.

Tehniskie dati

Darba spiediens:	maks. 1 MPa
Ieteicamais darba spiediens:	0,1 – 0,5 MPa
Pārbaudes spiediens:	1,6 MPa
(1 MPa = 10 bar = 147 PSI)	
Karstā ūdens temperatūra:	maks. 80 °C
Ieteicamā karstā ūdens temperatūra:	65 °C
Pieslēguma izmēri:	150 ±12 mm
G 1/2 pieslēgumi:	auksta pa labi - karsta pa kreisi
Drošības vārsts	

Simbolu nozīme



Viensvirs jaucējkrāns ar siltā ūdens ierobežošanu, ieregulēšanu skat. 33. lpp. Kombinācijā ar caurteces sildītāju karstā ūdens ierobežošana nav nepieciešama.



Apkope (skat. 37. lpp.)

Regulāri jāpārbauda pretvārsta funkcija saskaņā ar DIN EN 1717 saistībā ar nacionālajiem vai vietējiem noteikumiem (DIN 1988 vienreiz gadā).



Neizmantot silikonu, kas satur etiķskābi!



Izmērus (skat. 34. lpp.)



Caurplūdes diagramma (skat. 34. lpp.)



Rezerves daļas (skat. 35. lpp.)



Lietošana (skat. 36. lpp.)



Tīrīšana (skatiet pievienotajā brošūrā)





Pārbaudes zīme (skat. 40. lpp.)

Traucējums	Iemesls	Bojājumu novēršana
Maz ūdens	- Nefiltrs dušas filtra blīvējums - Pretvārsts ir iesprūdis	- Izītīt filtra blīvējumu starp dušu un šļūteni - Nomainīt pretvārstu
Jaucējkrāns smagi grozāms	- Bojāta kartuša, aizkaļķojusies	- Nomainīt kartušu
Jaucējkrāns pil	- Bojāta kartuša	- Nomainīt kartušu
Pārāk zema ūdens temperatūra	- Nepareizi noregulāta karstā ūdens bloķēšana	- Noregulēt karstā ūdens ierobežošanu
Neieslēdzas caurteces sildītājs	- Rokas dušā nav demontēts vārsts - Filtri neīri - Pretvārsts ir iesprūdis	- Izņemt no rokas dušas vārstu - Tīrīt / nomainīt filtrus - Nomainīt pretvārstu





Sigurnosne napomene

-  Prilikom montaže se radi sprečavanja prignječenja i posekotina moraju nositi rukavice.
-  Proizvod sme da se koristi samo za kupanje, tuširanje i ličnu higijenu.
-  Velika razlika u pritisku između vruće i hladne vode mora biti izbalansirana.

Instrukcije za montažu

- Armatura mora biti postavljena, isprana i testirana prema važećim normama.
- Hansgrohe armature se mogu koristiti u kombinaciji s hidraulički i termički kontrolisanim protočnim bojlerima ukoliko pritisak iznosi najmanje 0,15 MPa.

Tehnički podaci

Radni pritisak:	maks. 1 MPa
Preporučeni radni pritisak:	0,1 – 0,5 MPa
Probni pritisak:	1,6 MPa
(1 MPa = 10 bar = 147 PSI)	
Temperatura vruće vode:	maks. 80 °C
Preporučena temperatura vruće vode:	65 °C
Rastojanje između centara priključaka:	150 ± 12 mm
Priključci G 1/2:	hladna voda desno – topla leva
Zaštita od povratnog toka	

Opis simbola



Da bi ste podesili ograničavač vruće vode na jednoručnim mešačima, molimo Vas da pogledate stranicu 33. Podešavanje nije potrebno ako koristite protočni bojler.



Održavanje (vidi stranu 37)

Ispravno funkcionisanje nepovratnog ventila se mora redovno proveravati prema standardu DIN EN 1717 i u skladu s važećim nacionalnim ili regionalnim propisima (DIN 1988 jednom godišnje).



Nemojte koristiti silikon koji sadrži sirćetnu kiselinu!



Mere (vidi stranu 34)



Dijagram protoka (vidi stranu 34)



Rezervni delovi (vidi stranu 35)



Rukovanje (vidi stranu 36)



Čišćenje (vidi priloženoj brošuri)



Ispitni znak (vidi stranu 40)



Smetnja	Uzrok	Pomoć
Nedovoljno vode	- Mrežasta zaptivka tuša je prljava	- Očistite mrežastu zaptivku između tuša i crijeva
	- Nepovratni ventil se nije vratio u početni položaj	- Zamenite nepovratni ventil
Ručica se zaglavila	- Neispravna kartuša, nataloženi kamenac	- Zamenite kartušu
Slavina kaplje	- Neispravna kartuša	- Zamenite kartušu
Preiska temperatura tople vode	- Ograničavač vruće vode nije dobro podešen	- Podesite ograničavač vruće vode
Protočni bojler ne radi	- Prigušnica u ručnom tušu nije odstranjena	- Odstranite prigušnicu iz ručnog tuša
	- Mrežice za hvatanje prljavštine su prljave	- Očistite / zamenite mrežicu za hvatanje prljavštine
	- Nepovratni ventil se nije vratio u početni položaj	- Zamenite nepovratni ventil



Montaža vidi stranu 31



Sikkerhetshenvisninger

-  Bruk hansker under montasjen for å unngå klem- og kuttskader.
-  Dusjsystemet skal kun brukes for bade-, hygiene- og kroppshygiene.
-  Store trykkdifferanser mellom kaldt- og varmtvannstilkoblinger skal utlignes.

Montagehenvisninger

- Armaturen skal monteres, spyles og sjekkes iht. gyldige standarder.
- Armaturer fra Hansgrohe kan brukes sammen med hydraulisk og termisk stryrt gjennomstrømningsover når gjennomstrømningstrykket er på minst 0,15 MPa.

Tekniske data

Driftstrykk	maks. 1 MPa
Anbefalt driftstrykk:	0,1 – 0,5 MPa
Prøvetrykk (1 MPa = 10 bar = 147 PSI)	1,6 MPa
Varmtvannstemperatur	maks. 80 °C
Anbefalt temperatur for varmt vann	65 °C
Tilkoblingsmål:	150 ± 12 mm
Tilkoblinger G 1/2	kaldt høyre - varm venstre
Egensikker mot tilbakeflyt	

Symbolbeskrivelse



Enhåndblande batteri med varmtvannsbegrensning. For justering se side 33. I forbindelse med en gjennomstrømningsover er det ikke nødvendig med varmtvannsbegrensning.



Vedlikehold (se side 32)

Funksjonen til returløpssperren skal iht. DIN EN 1717 og i samsvar med de nasjonale og lokale forskrifter sjekkes regelmessig (DIN 1988 en gang i året).



Ikke bruk silikon som inneholder eddiksyre!



Mål (se side 34)



Gjennomstrømningsdiagram (se side 34)



Servicedeler (se side 35)



Betjening (se side 36)



Rengjøring (se vedlagt brosjyre)



Prøvemerke (se side 40)



Feil	Årsak	Feilrettelse
Lite vann	- Dusjens silpakning er skitten	- Silpakning mellom dusj og slangen rengjøres
	- Returløpstopper sitter fast	- Returløpstopper byttes
Armatur ikke lett bevegelig	- Kartusj defekt, forkalkning	- Kartusj byttes
Armatur drypper	- Kartusj defekt	- Kartusj byttes
For lav varmtvannstemperatur	- Varmtvannsbegrensning er feil innstilt	- Varmtvannsbegrensning innstilles
Gjennomstrømningsover innkobler ikke.	- Drossel til hånddusjen ikke fjernet	- Drossel fjernes fra hånddusjen
	- Smussfangersil skitten	- Smussfangersil rengjøres / byttes
	- Returløpstopper sitter fast	- Returløpstopper byttes



Montasje se side 31



Указания за безопасност

-  При монтажа трябва да се носят ръкавици, за да се избегнат наранявания поради притискане или порязване.
-  Позволено е използването на продукта само за къпане, хигиена и цели на почистване на тялото.
-  Големите разлики в налягането между изводите за студената и топлата вода трябва да се изравняват.

Указания за монтаж

- Арматурата трябва да се монтира, промие и провери в съответствие с валидните норми.
- Арматурите на Hansgrohe могат да се използват във връзка с хидравлично и термично управляеми проточни нагреватели, ако хидравличното налягане е минимум 0,15 МПа.

Технически данни

Работно налягане:	макс. 1 МПа
Препоръчително работно налягане:	0,1 – 0,5 МПа
Контролно налягане:	1,6 МПа
(1 МПа = 10 bar = 147 PSI)	
Температура на горещата вода:	макс. 80 °C
Препоръчителна температура на горещата вода:	65 °C
Присъединителни размери:	150 ± 12 mm
Изводи G 1/2:	студено отцясно – топло отляво
Самозащитен против обратно изтичане	

Описание на символите



Смесител с една ръкохватка с ограничител за топлата вода, юстирането вижте на стр. 33. Във връзка с проточни нагреватели не е необходима блокировка за топлата вода.



Поддръжка (вижте стр. 37)

Съгласно DIN EN 1717 редовно трябва да се проверява функционирането на приспособленията за предотвратяване на обратния поток в съответствие с националните или регионални изисквания (DIN 1988 веднъж годишно). Не използвайте силикон, съдържащ оцветна киселина!



Размери (вижте стр. 34)



Диаграма на потока (вижте стр. 34)



Сервизни части (вижте стр. 35)



Обслужване (вижте стр. 36)



Почистване (от приложената брошура)



Контролен знак (вижте стр. 40)





Неизправност	Причина	Помощ
Малко вода	- Замърсено е уплътнението с цедка на разпръскателя - Здраво стоящо приспособление за предотвратяване на обратния поток	- Почистете уплътнението с цедка между разпръскателя и маркуча - Смяна на приспособлението за предотвратяване на обратния поток
Трудно подвижна арматура	- Дефектна гилза, покрита с варовик	- Сменете гилзата
Арматурата капе	- Дефектна гилза	- Сменете гилзата
Твърде ниска температура на водата	- Ограничението за топлата вода е грушно настроено	- Настройте ограничението за топлата вода
Проточният нагревател не се включва	- Дроселът в ръчния разпръскател не е демонтиран - Цедките за улавяне на замърсяванията са замърсени - Здраво стоящо приспособление за предотвратяване на обратния поток	- Отстранете дросела от ръчния разпръскател - Почистете / сменете цедките за улавяне на замърсяванията - Смяна на приспособлението за предотвратяване на обратния поток



Монтаж вижте стр. 31



Udhëzime sigurie

-  Për të evituar lëndimet e pickimeve ose të prerjeve gjatë procesit të montimit duhet që të vishni doreza.
-  Produkti duhet të përdoret vetëm qëllimet e banjave, të higjienës dhe të larjes së trupit.
-  Ndryshimet e mëdha të presionit mes lidhjeve të ujit të ftohtë dhe atij të ngrohtë duhen ekuilibruar.

Udhëzime për montimin

- Armatura duhet montuar, shpërlarë dhe kontrolluar në bazë të normave të vlefshme.
- Armaturat e Hansgrohe mund të përdoren në kombinim me ngrohës elektrikë të ujit të drejtuar në mënyrë hidraulike ose termike nëse presioni i rrjedhjes është minimumi 0,15 MPa.

Të dhëna teknike

Presioni gjatë punës	maks. 1 MPa
Presioni i rekomanduar:	0,1 – 0,5 MPa
Presioni për provë:	1,6 MPa
(1 MPa = 10 bar = 147 PSI)	
Temperatura e ujit të ngrohtë	maks. 80 °C
Temperatura e rekomanduar e ujit të ngrohtë:	65 °C
Përmasat e lidhjeve:	150 ± 12 mm
Lidhjet G 1/2:	i ftohtë djathtas - i ngrohtë majtas
Siguresa kundër rrjedhjes në drejtim të kundërt	

Përshkrimi i simbolit



Rubinet me ujë të përzier me kufizim të ujit të ngrohtë, justimi shih faqen 33. Në kombinim me ngrohësit elektrikë të ujit nuk ka nevojë për bllokadë të ujit të ngrohtë.



Mirëmbajtja (shih faqen 37)

Penguesit e rrjedhjes në drejtim të kundërt duhen kontrolluar rregullisht në bazë të normave DIN EN 1717 konform normave nacionale dhe regionale (DIN 1988 një herë në vit).



Mos përdorni silikon që në përbërje ka acid acetik.



Përmasat (shih faqen 34)



Diagrami i qarkullimit (shih faqen 34)



Pjesë ndërrimi (shih faqen 35)



Përdorimi (shih faqen 36)



Pastrimi (shikoni broshurën bashkëngjitur)



Shenja e kontrollit (shih faqen 40)

Demtim	Shkaku	Ndihme
Pak ujë	- Gomina hermetizuese e pajisjes me papasterti - Penguesi i rrjedhjes mbrapsht te ujit qendron i fiksuar	- Pastroni gominen e sites midis pajisjes dhe tubit - Kembeni pernguesin e rrjedhjes mbrapsht te ujit
Armatura punon rende	- Kartusha me defekt, me kalk	- Kembeni kartushen
Armatura pikon	- Kartusha me defekt	- Kembeni kartushen
Temperaturë e ulët e ujit të ngrohtë	- Kufiri i ujit te ngrohte eshte regjistruar gabim	- Regjistroni kufirin e ujit te ngrohte
Ngrohësi i ujit nuk ndizet.	- Rregulluesi i ujit në tubacione nuk është i hequr nga spërkatësja - Sita qe mbledh papasterite eshte e piset - Penguesi i rrjedhjes mbrapsht te ujit qendron i fiksuar	- Hiqni rregulluesin e ujit në tubacione nga spërkatësja - Pastroni/Kembeni siten qe mbledh papasterite - Kembeni pernguesin e rrjedhjes mbrapsht te ujit





تنبيهات الأمان



- يجب ارتداء قفازات لليد أثناء التركيب لتجنب حدوث أخطار الإنحشار أو الجروح.
- لا يجب استخدام نظام الدش إلا في أغراض الاستحمام والأغراض الصحية وأغراض تنظيف الجسم.
- يجب أن يكون تيار الماء الساخن والماء البارد متعادلين في الضغط.



وصف الرمز



اضبط محدد الماء الساخن في الخلاطات ذات المقبض الواحد، يرجى الرجوع إلى صفحة 33. ولا يلزم إجراء أي ضبط عند استخدام سخان مياه ذي تدفق مستمر.

الصيانة (راجع صفحة 37)



يجب فحص صمام عدم الرجوع بصفة منتظمة حسب المواصفة DIN EN 1717 وذلك طبقاً للوائح الوطنية أو الإقليمية (مرة واحد سنوياً طبقاً للمواصفة DIN 1988).

هام! لا تستخدم السليكون الذي يحتوي على أحماض!

أبعاد (راجع صفحة 34)



رسم للصرف (راجع صفحة 34)

قطع الغيار (راجع صفحة 35)



التشغيل (راجع صفحة 36)



التنظيف (راجع والكتيب المرفق)



شهادة اختبار (راجع صفحة 40)



تعليمات التركيب

- يجب تركيب الوصلة واستخدامها واختبارها وفقاً للمعايير المعمول بها.
- يمكن استخدام خلاطات هانزجر وهي مع سخانات تدفق الماء ذات التحكم الهيدروليكي و الحراري، مع ضغط تدفق لا يقل عن 0,15 ميجاباسكال.

المواصفات الفنية

- ضغط التشغيل: الحد الأقصى 1 ميجاباسكال
- ضغط التشغيل الموصى به: 0,1 - 0,5 ميجاباسكال
- ضغط الاختبار: 1,6 ميجاباسكال
- (1 ميجاباسكال = 10 بار = 147 PSI)
- درجة حرارة الماء الساخن: الحد الأقصى 80°C
- درجة الحرارة الموصى بها للماء الساخن: 65°C
- المسافة المركزية: 150 ± 12 mm
- الوصلات: 1/2 G الماء البارد جهة اليمين - الماء الساخن جهة اليسار
- خاصية عدم التدفق العكسي

العلاج والإصلاح

السبب

العطل

- نظف سداة المصفاة بين الدش والخرطوم	- سداة مصفاة الدش متسخة	الماء غير كافٍ
- قم بتغيير صمام منع الرجوع	- صمام منع الرجوع ثابت ولا يتحرك	
- قم بتغيير الخرطوشة	- الخرطوشة تالفة، تراكم عليها الجير	الخلاط ثقيل الحركة
- قم بتغيير الخرطوشة	- الخرطوشة تالفة	تساقط قطرات مياه من الخلاط
- قم بضبط محدد الماء الساخن	- محدد الماء الساخن مضبوط بشكل خاطيء	درجة حرارة الماء الساخن منخفضة للغاية
- انزع محدد التدفق من الدش	- محدد التدفق غير مخلوع من الدش	السخان الفوري لا يعمل
- قم بتنظيف / تغيير الفلتر	- الفلتر متسخ	
- قم بتغيير صمام منع الرجوع	- صمام منع الرجوع ثابت ولا يتحرك	

الترايب راجع صفحة 31



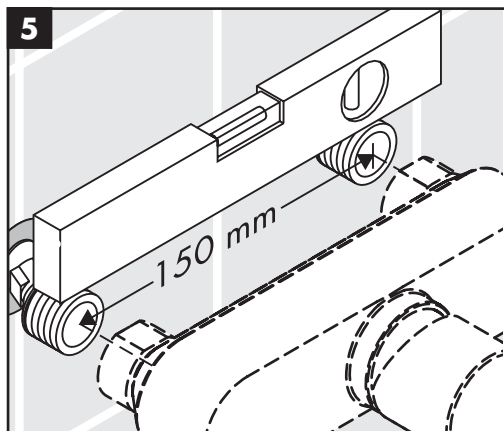
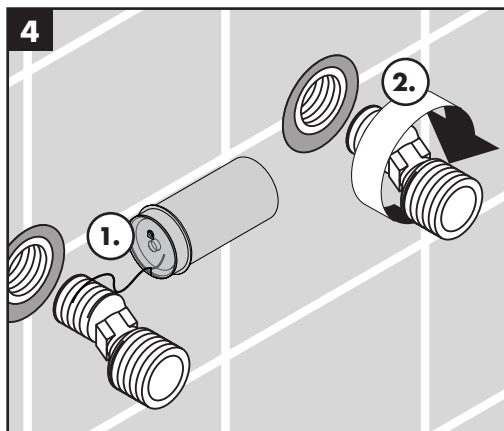
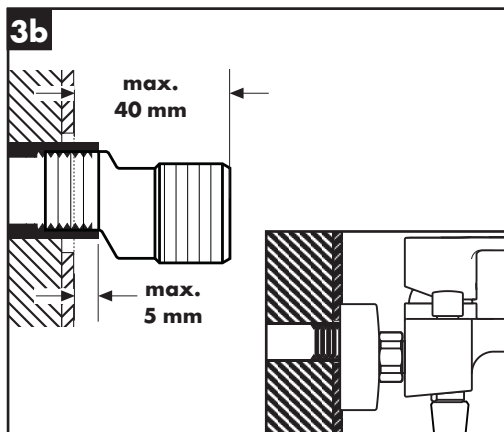
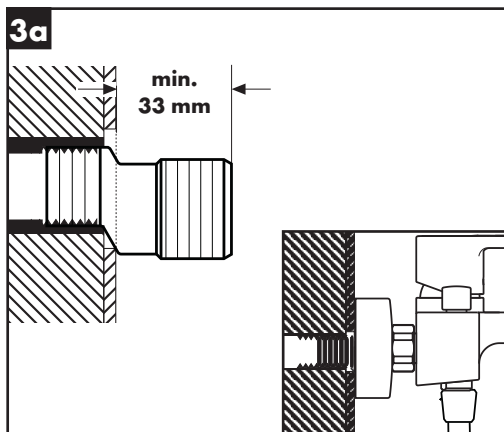
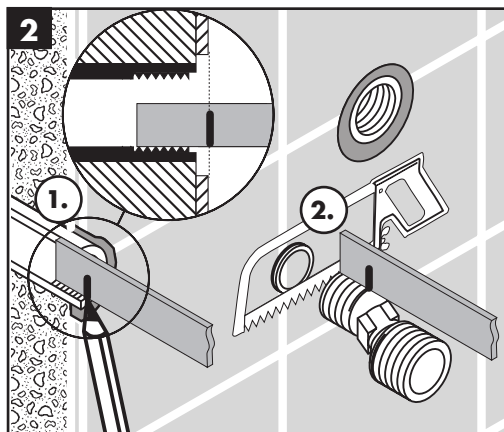
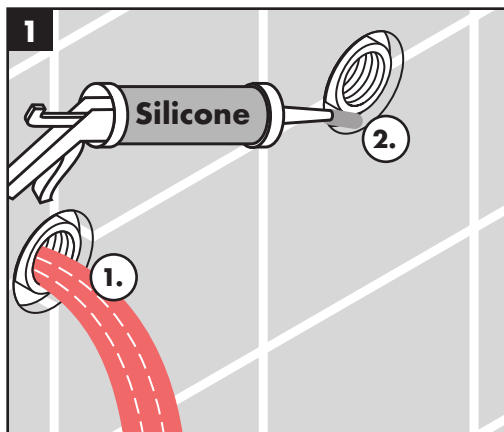

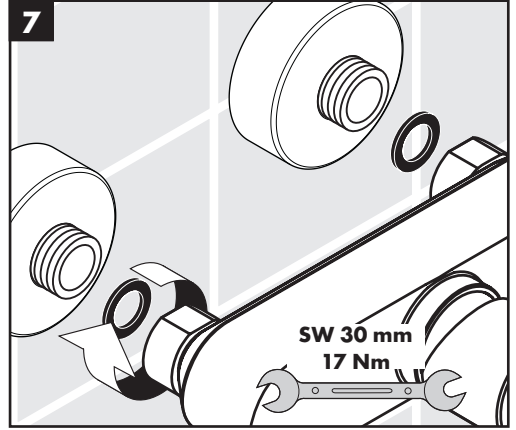
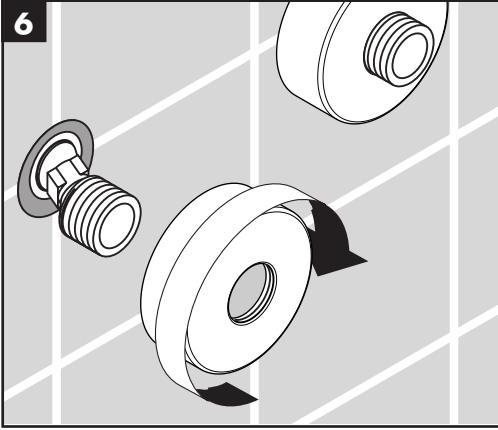

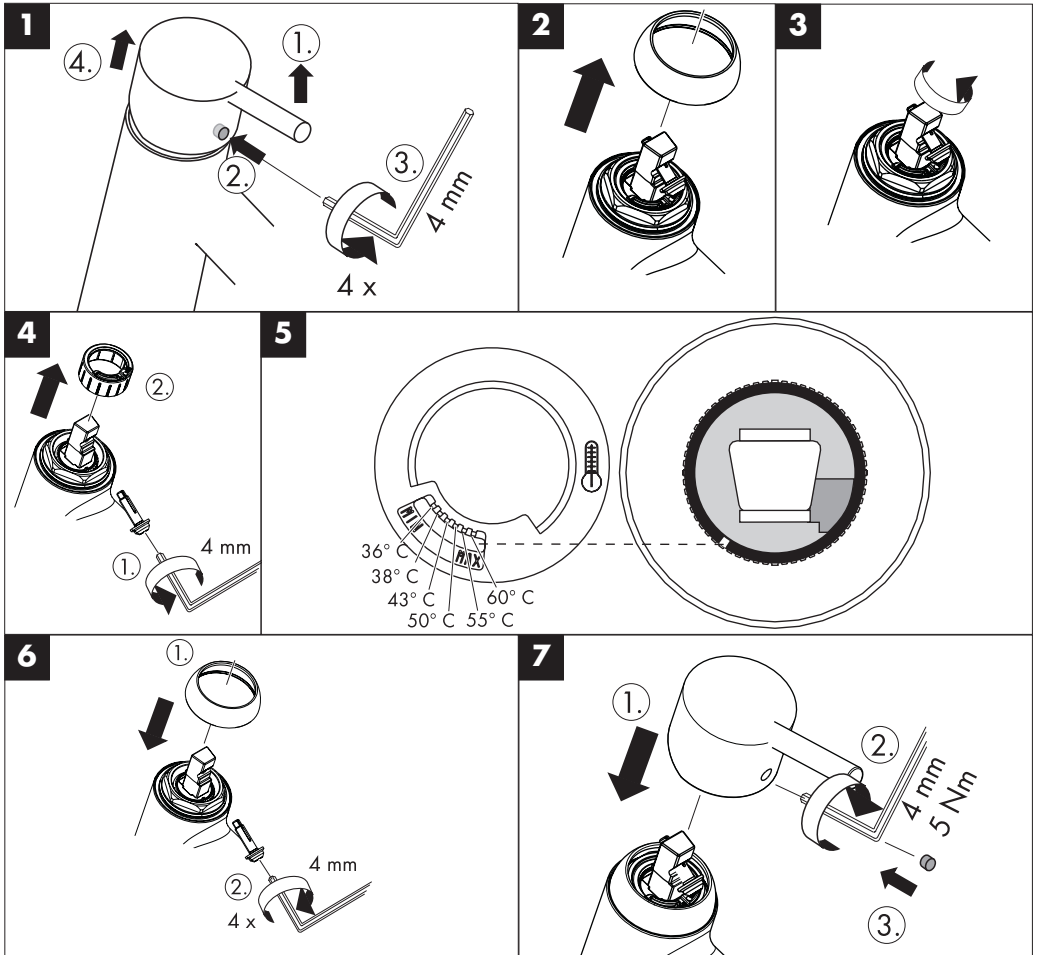
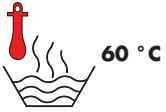



14432000

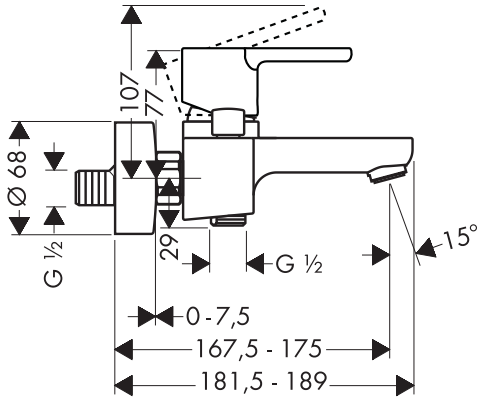

14632000

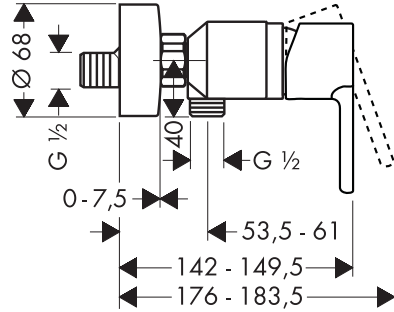

14432000

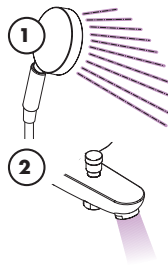
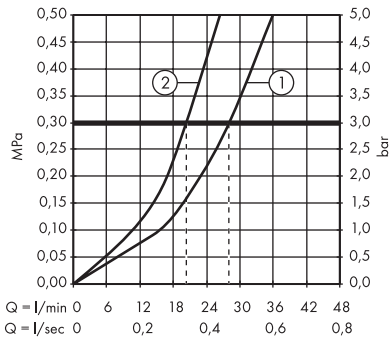

14632000

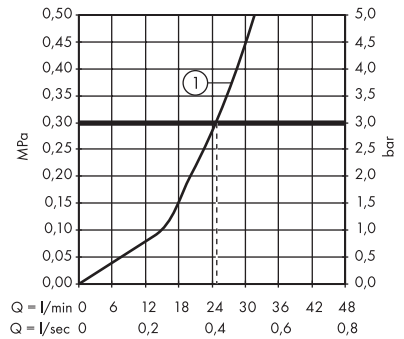



14432000

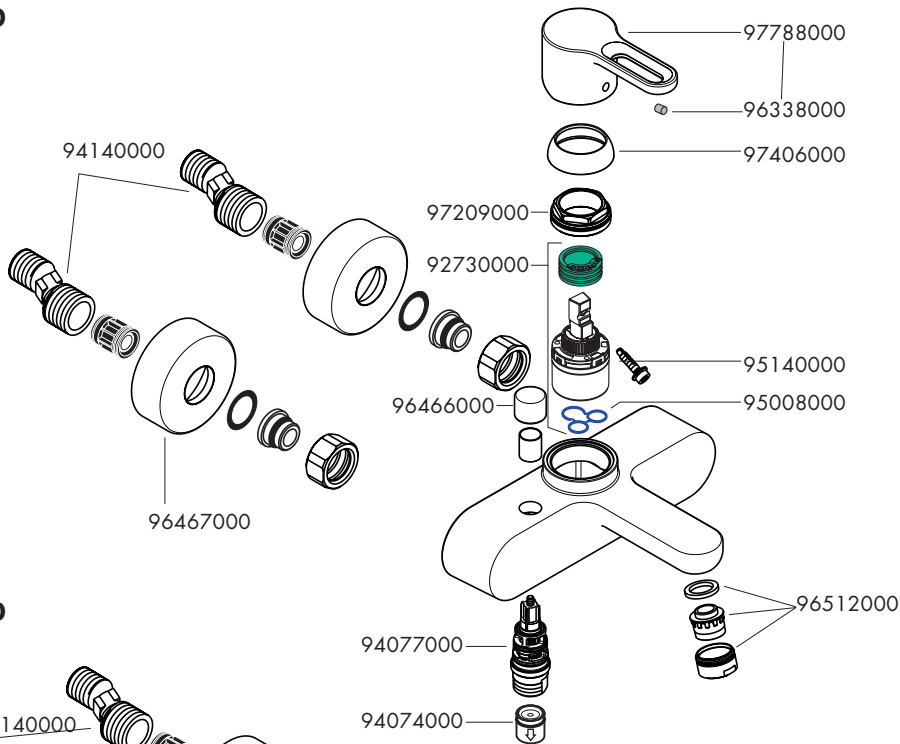

14632000

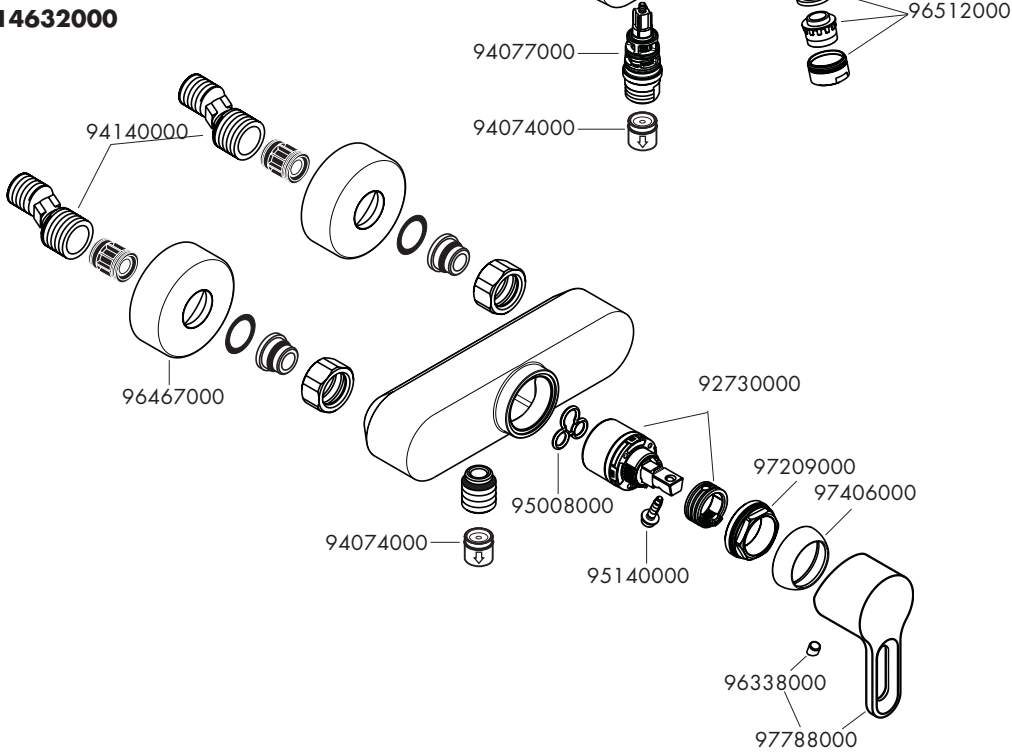

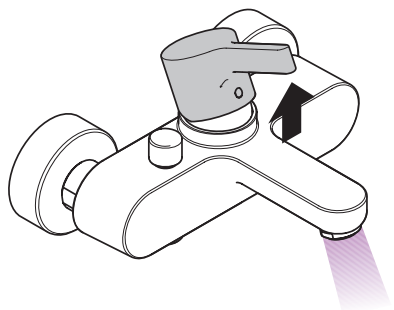

öffnen / ouvert / open / aperto / abierto / open / åbne /
 abrir / otworzyć / otevřít / otvorit / 开 / открыть / nyitás /
 avaaminen / öppna / atidaryti / Отваранье / açmak /
 deschide / ανοικτό / odpreti / avage / atvērt / otvoriti /
 åpne / отварање / hare / فتح

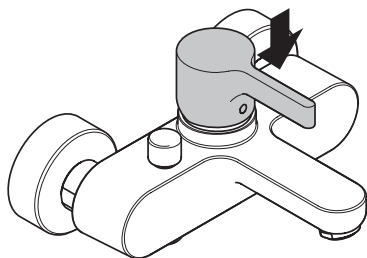

schließen / fermé / close / chiudere / cerrar / sluiten /
 lukke / fechar / zamknąć / zavřít / uzavrieti / 关 /
 закрыть / bezárás / sulkeminen / stänga / uždaryti /
 Zatvaranje / kapatmak / închide / κλειστό / zapreti /
 sulgege / aizvērt / zatvori / lukke / затварање / mbylle /
 إغلاق

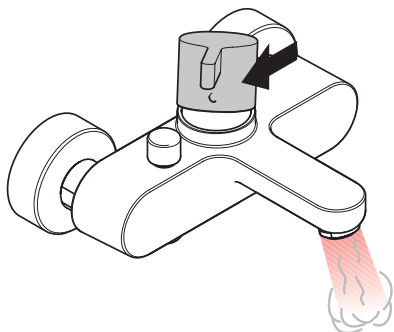

warm / chaud / hot / caldo / caliente / warm / varmt /
 quente / ciepła / teplá / teplá / 热 / горячая / meleg /
 lämmin / varmt / karštas / Vruća voda / sıcak / cald /
 ζεστό / toplo / kuum / karsts / topla / varm / тепло /
 i ngrohtë / ساخن

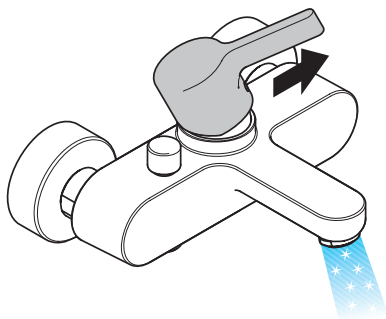

kalt / froid / cold / freddo / frío / koud / koldt / fria /
 zimna / studená / studená / 冷 / холодная / hideg /
 kylmä / kallt / šaltas / Hladno / soğuk / rece / krūo /
 mrzlo / külm / auksts / hladno / kaldt / студено / i ftohtë /
 بارد

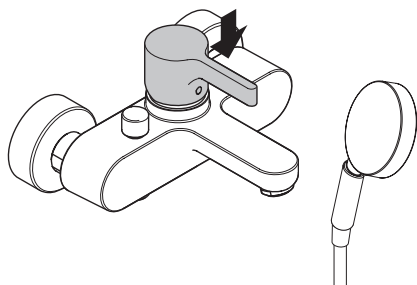
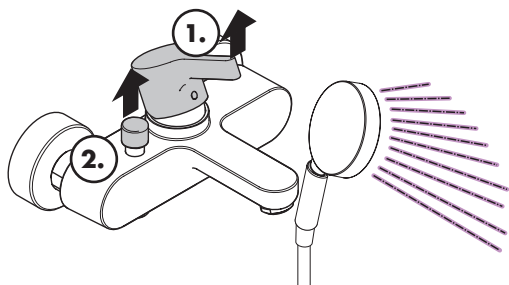

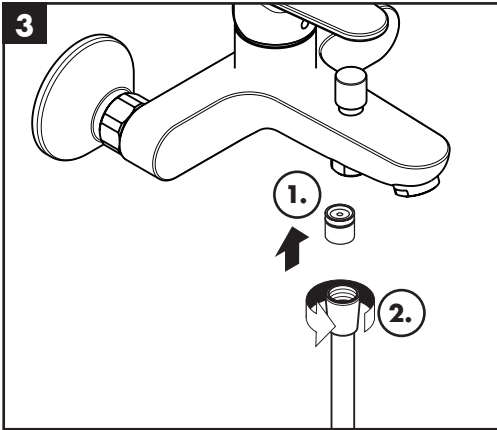
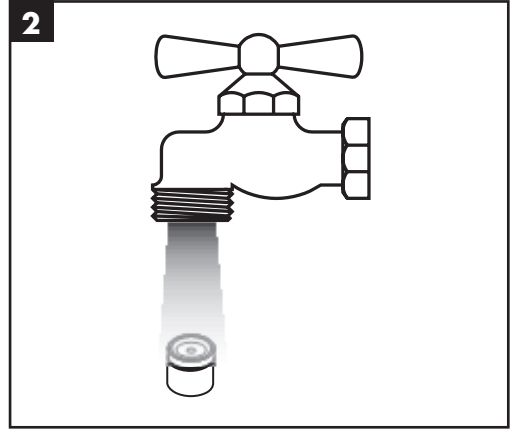
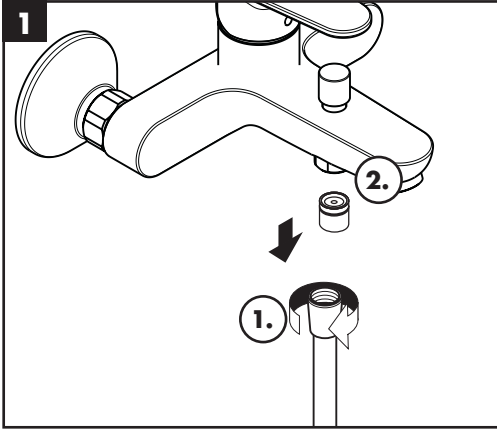







	P-IX	DVGW	SVGW	ACS	WRAS	KIWA	ETA
14432000	PA-IX 9952/ICB	BR5786	X			X	
14632000	PA-IX 9953/IB	BR5786	X			X	



hansgrohe