

Axor ShowerCollection with Philippe Starck

Information & inspiration for professionals

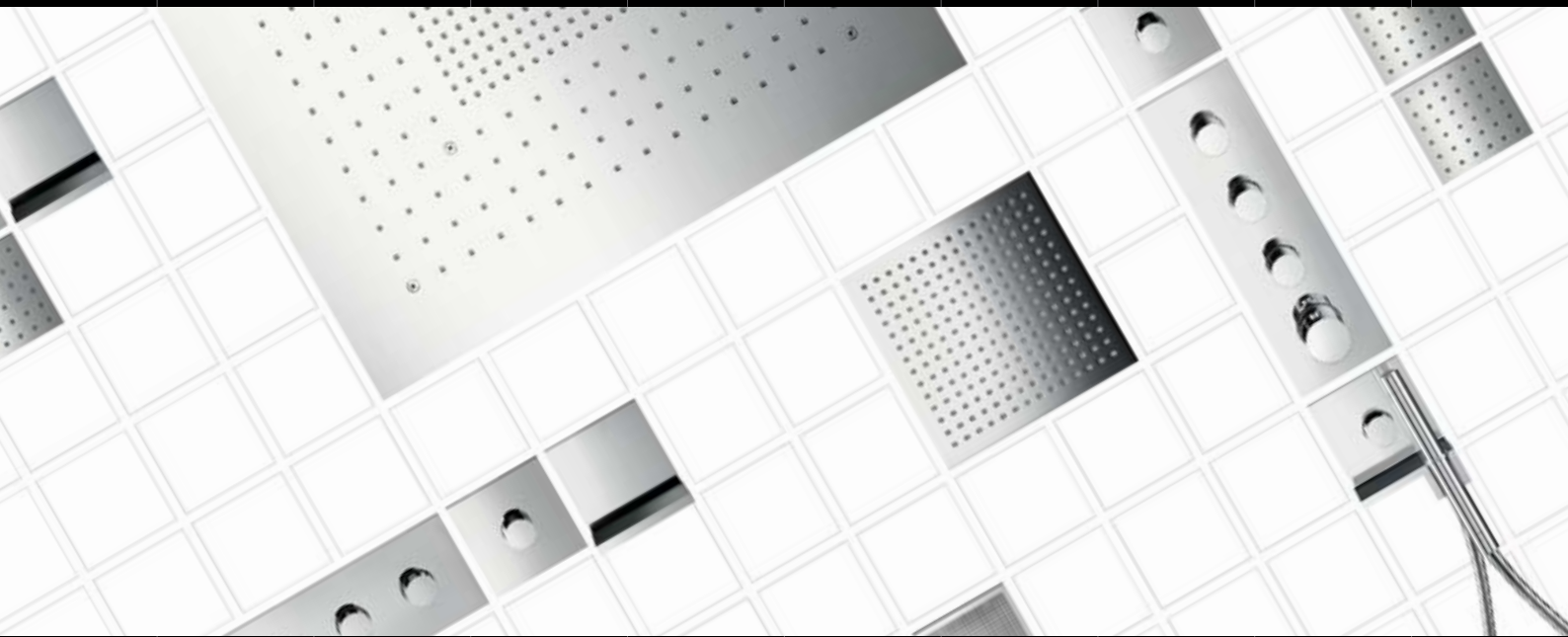

AXOR[®]
hansgrohe

CONTENTS

- 04 The principle
- 10 The planning examples
- 35 The installations
- 43 The product overview
- 50 The references

PHILIPPE STARCK

Philippe Starck is one of the best known creative minds of our time. Many people regard him as having a stroke of genius, which is regularly displayed with his playful and often spectacular style.

- Interior and general designer
- Born in Paris, France, in 1949
- Founded the company "Starck Product" in 1979
- His partners include Kartell, Alessi, Duravit, Driade, Fossil and Cassina
- Projects: Yoo Apartments, motor yacht A, Café Costes in Paris, Hotel St. Martins Lane in London
- Cooperation with Axor since 1992

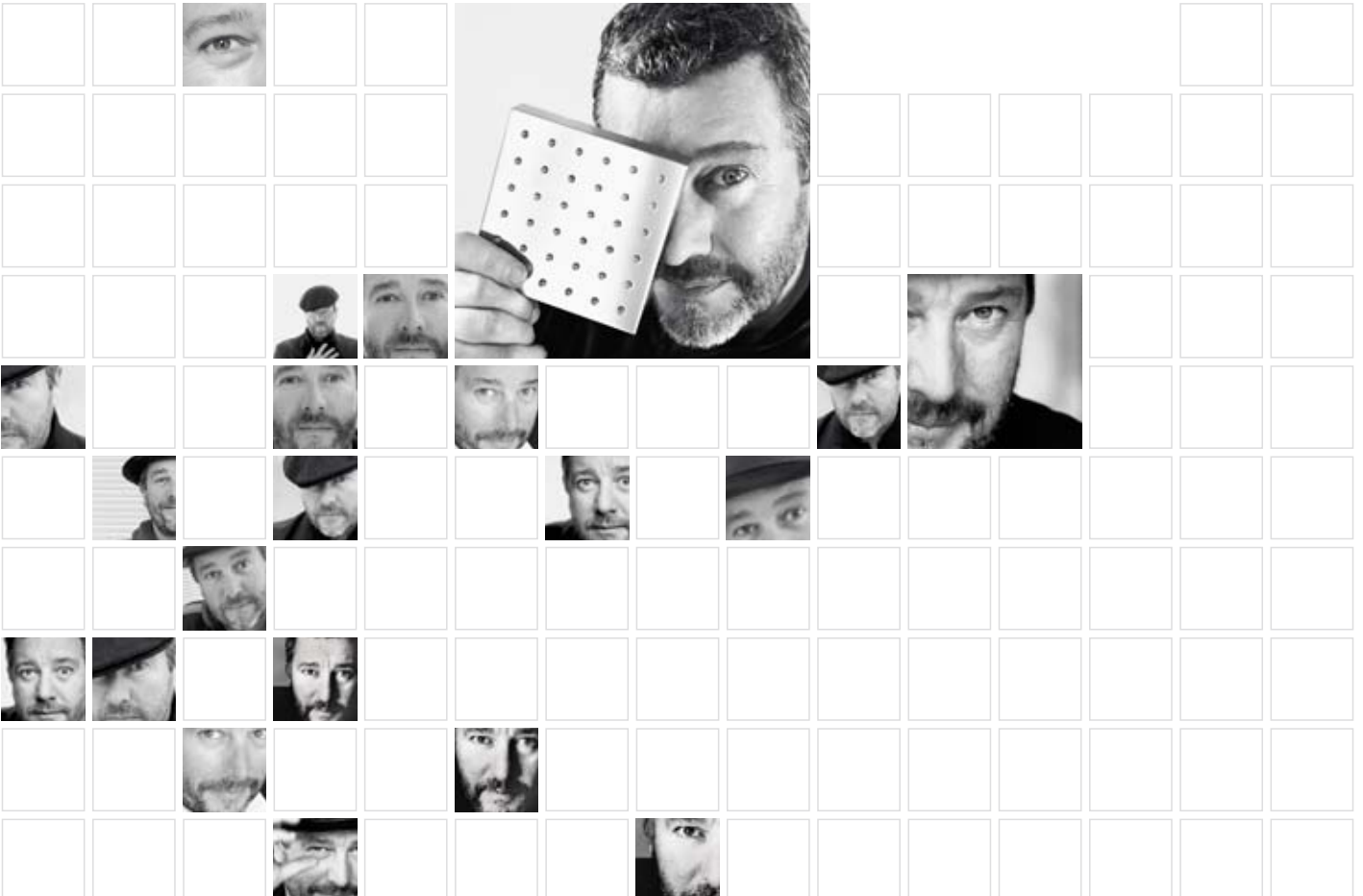



Axor ShowerCollection with Philippe Starck

Haute Couture for the Shower.

How much potential is there in a square? The Axor ShowerCollection just goes to show that there is in fact a vast amount. Showers, mixers and accessories that can be freely positioned to offer custom solutions, which can be perfectly tailored to the requirements of the customer.

Each individual element in the collection has been developed by Axor and Philippe Starck based on a 12 cm x 12 cm square. On the following pages, you can see for yourself how perfectly all the components match up.

In this brochure we would also like to tell you all about the elaborate concealed basic sets in the Axor ShowerCollection and the sophisticated modular principle, which makes them really easy to assemble. Comprehensive planning examples provide you with lots of detailed information on installation and valuable installation tips.

This professional brochure shows you how easy it is to turn your shower into your own personal spa using the Axor ShowerCollection.

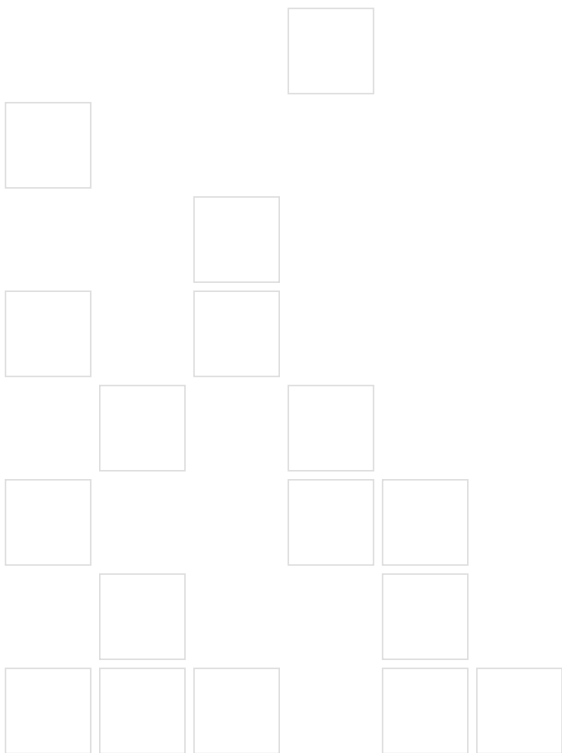

Just

mix

it!

The concept

A simple modular system, whose components can be almost entirely freely combined - that's the essence of the Axor ShowerCollection. "Just mix it!" is therefore the motto for individuality and creativity in shower planning. From thermostat to overhead shower, from shelf to ShowerHeaven, the customer simply selects which elements he would like to use.

The Axor ShowerCollection is also impressive behind the wall, with well-structured and easy-to-install solutions. So the collection combines ultimate freedom of design with total reliability in implementation, in any situation.

The "Just mix it!" principle has proven successful everywhere - whether it's a small standard shower or an ample spa.

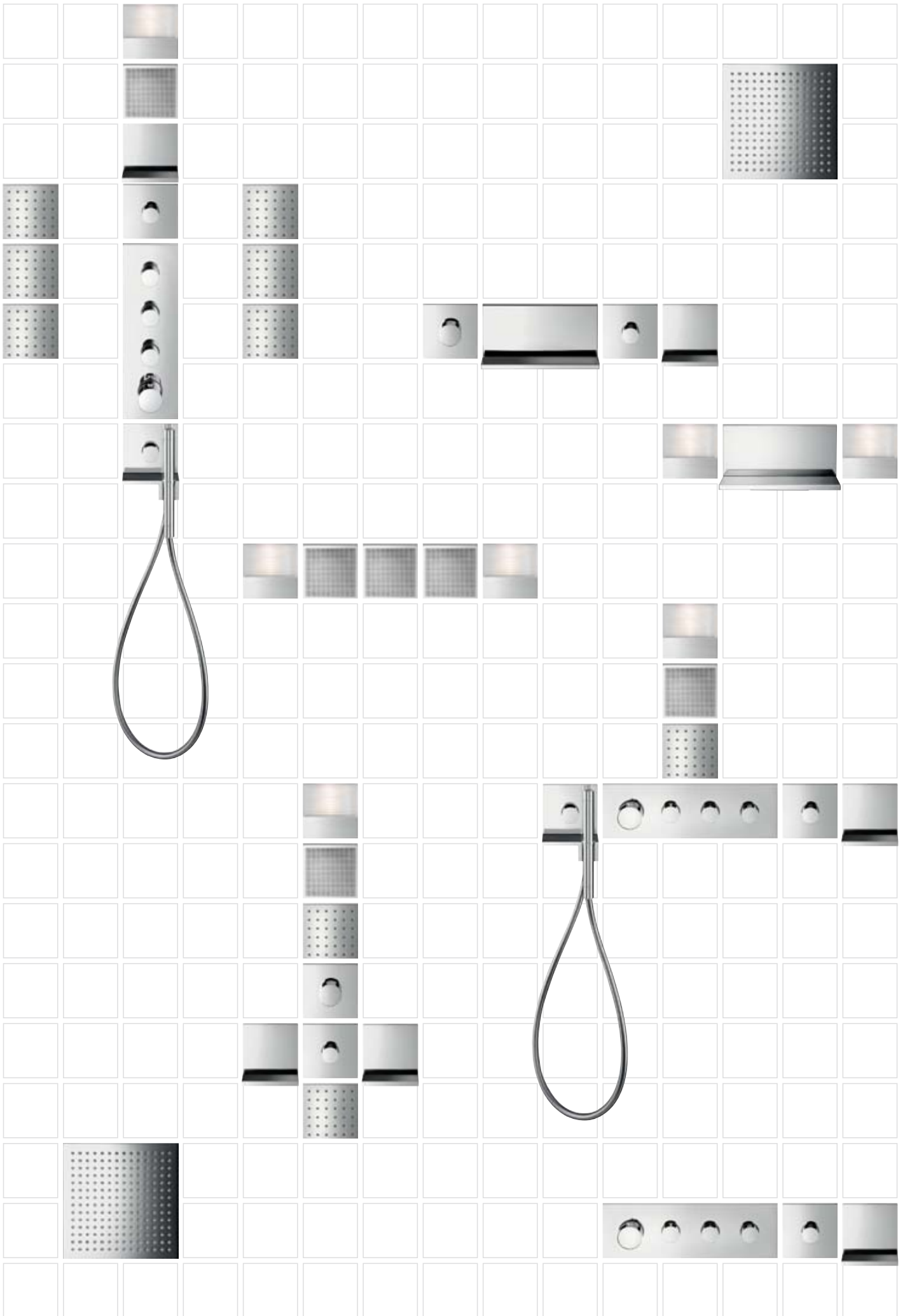

The concept

Squaring the circle

Few shower systems are as versatile as the Axor ShowerCollection. Philippe Starck carries on the aesthetics of minimalism with this shower collection, and all modules are based on the 12 x 12 principle.

So you have the following options:

- A harmonious shower solution for all design languages and Axor collections
- A wide variety of design options thanks to the "Just-mix-it!" philosophy

The collection

- 01_Thermostat module 36 x 12**
- 02_Thermostat module 12 x 12**
- 03_Shut-off valve 12 x 12**
- 04_Trio®/Quattro® diverter valve 12 x 12**
- 05_Handheld shower module 12 x 12**
- 06_Flood spout 24 x 12**
- 07_Shower module 12 x 12**
- 08_Overhead shower 24 x 24**
- 09_ShowerHeaven 72 x 72**
- 10_ShowerHeaven 97 x 97**
- 11_Light module 12 x 12**
- 12_Speaker module 12 x 12**
- 13_Shelf 12 x 12**

01



02



03



04



05



The mixers

Based on a 12 x 12 cm square, the mixers can be installed separately or as a multi-functional system:

- Basis: thermostat module with or without integrated shut-off valves (01 + 02)
- Other shut-off and diverter control units can be combined in addition (03 + 04)
- Particularly practical: shut-off valve with integrated hose connection and hand shower (05)

06



The waterfall spout

The inflow with invigorating flood spray is a new module within the collection.

- Flood spray can be used as a bath filler with spacious shelf
- Can be used alternatively as a neck shower
- Also ideal for the spa area

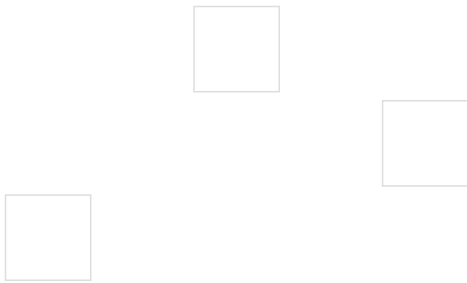

08

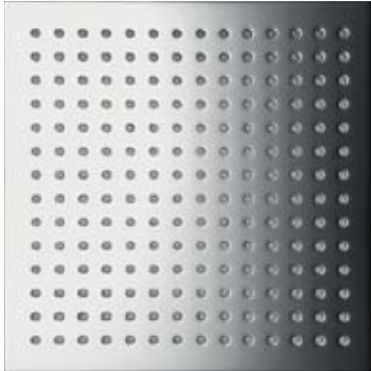

07



The showers

Thanks to the huge variety of shower products, you are guaranteed to be able to offer your customer his/her own customised shower experience:

Shower module (07), 12 x 12 cm

- Can be used as an overhead, neck or body shower
- Can be used as an individual item or in units of 4, 6 or 9 modules

Overhead shower (08), 24 x 24 cm

- The ample pleasurable shower experience for smaller bathrooms
- Also available in a version that is flush with the ceiling, with ceiling connector or for classic wall mounting with shower arm
- Easy to clean thanks to removable spray disc (see P. 42)

ShowerHeaven (09 + 10)

- Particularly luxurious: the ShowerHeaven with 3 different jet types
- In 2 different sizes
- Available with light on request
- Can be installed as an exposed or concealed solution



09

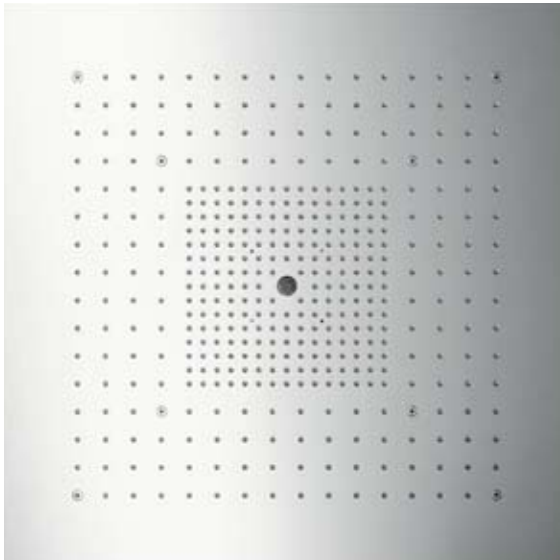

10

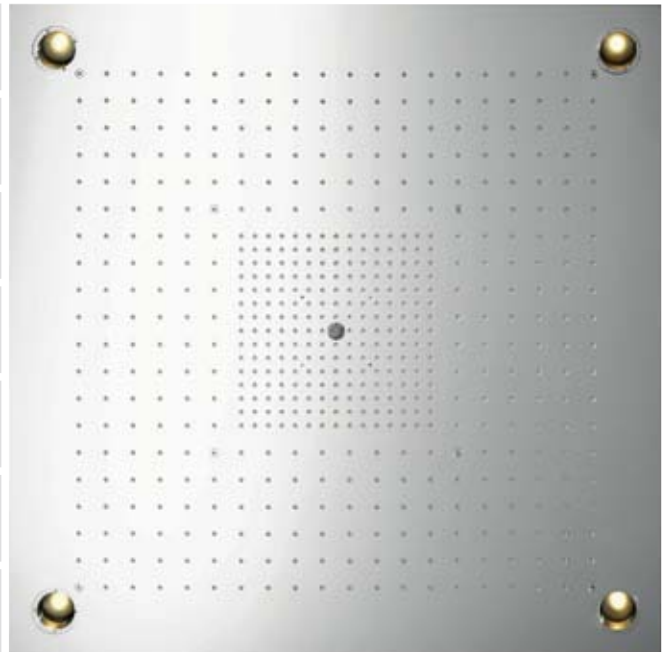

06
07



The accessories

In addition to the functional modules, additional elements enhance the Axor ShowerCollection:

- For a particularly sensual showering experience: light (11) and loudspeaker module (12)
- Practical shelving in 12 x 12 cm (13) and 24 x 12 cm format



11



12

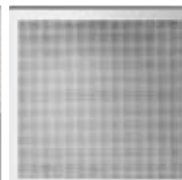

13



The principle

The ShowerHeaven

3 different jet types guarantee a truly special water experience when using the ShowerHeaven:

- The "Bodyzone" (01) in the outer overhead shower zone; flow performance at 3 bar: 33.3 l/min
- The central "Rainzone" (02) with AirPower function; flow performance at 3 bar: 20.6 l/min
- The powerful Laminar spray (03) with 17 mm diameter; flow performance at 3 bar: 15.6 l/min
- All 3 jet types can be used individually or in combination (04); flow performance at 3 bar:
 Rainzone + Laminar = 32.1 l/min;
 Rainzone + Bodyzone = 42.4 l/min;
 Bodyzone + Laminar = 40.5 l/min

All 3 spray zones are controlled via 3 valves or 1 diverter valve with 3 outlets.



The shower module as an overhead shower

If the shower module is used as an overhead shower, this opens up the following options:

- Can be positioned in different patterns depending on the requirement - for completely customised spray patterns (05)
- 1, 4, 6 or 9 shower modules can be used if used as an overhead shower (06)
- Flow rate: approx. 5 l/min at 3 bar per module



05

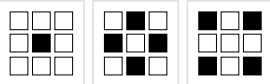

06

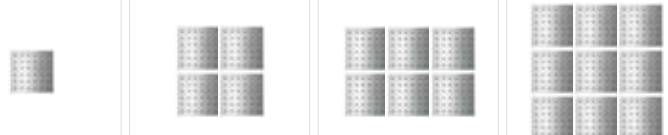

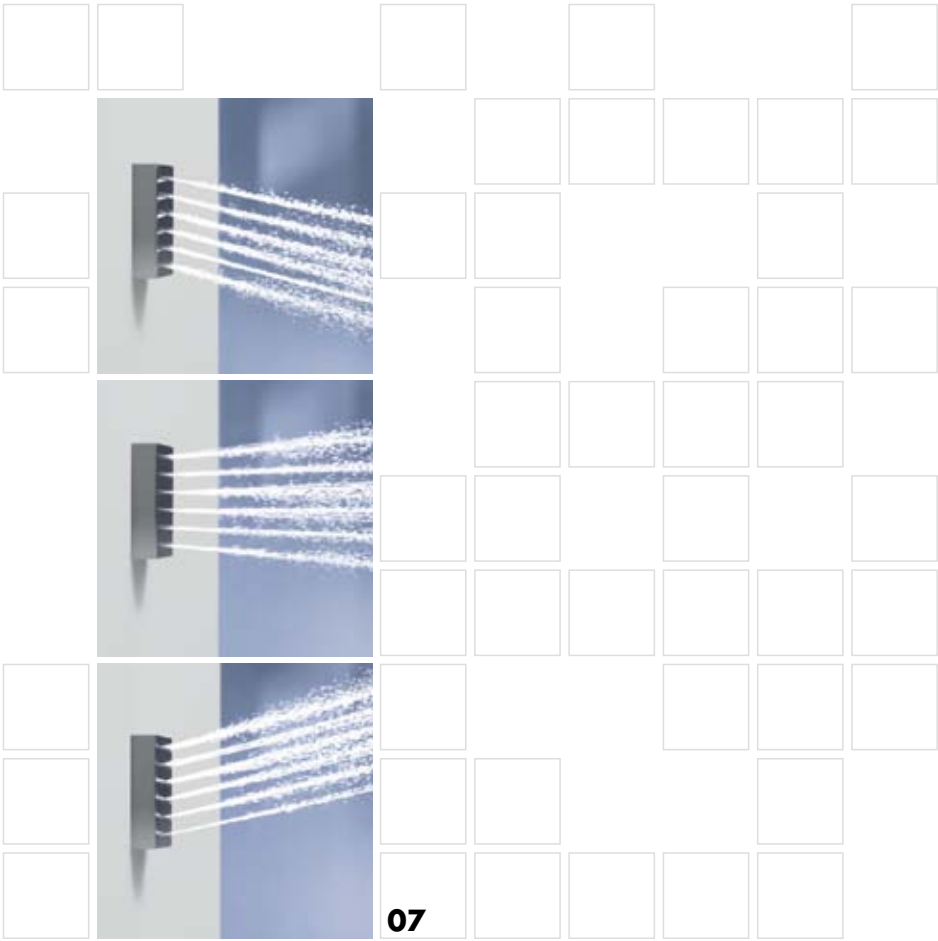

07

The overhead showers

The jet is a particularly soft shower rain, thanks to AirPower technology.
 · Flow rate: 12 l/min or 25 l/min at 3 bar

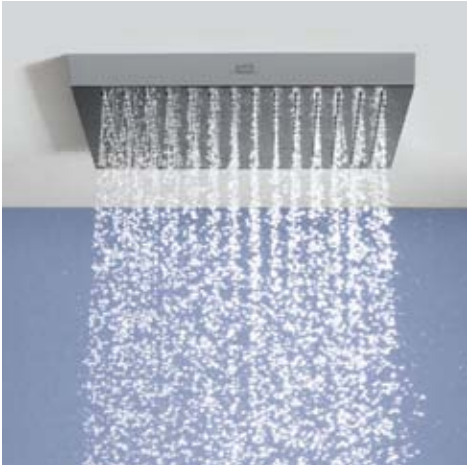

The shower module as a body shower

The shower module can be used as a neck or body shower, with the following advantages:
 · Thanks to its adjustability at 5 vertical levels (07), the jets can be adapted to different body sizes
 · Flow rate: approx. 5 l/min at 3 bar

If the shower modules are rotated by 90° when installed, the water jets can be adjusted horizontally. So the jet can either hit the body over a larger area (08) or at a certain point (09).

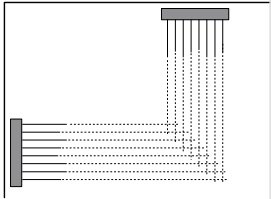

08

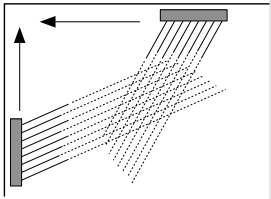

09

08
09

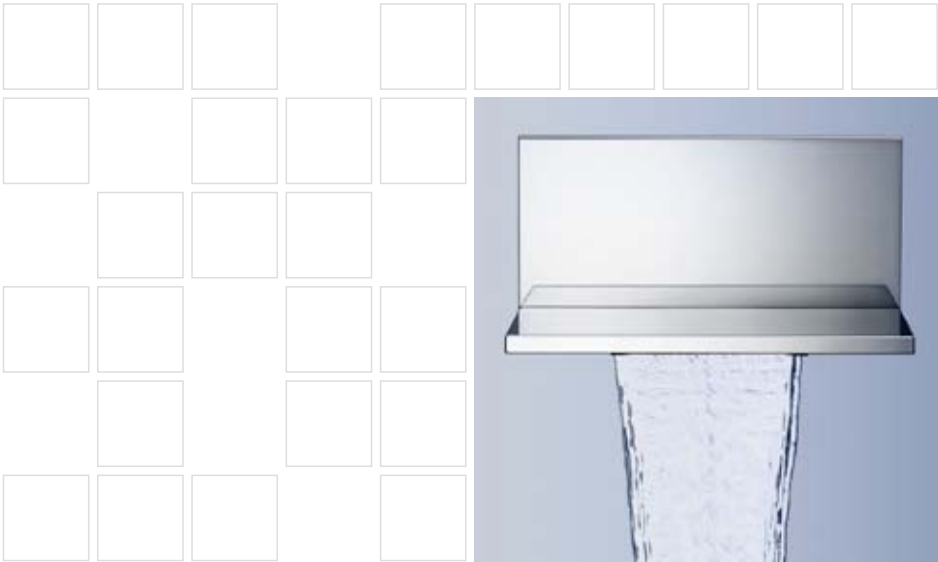

The waterfall spout

The waterfall spout offers several functions and can be used in different ways.
 · For filling the bath tub or as a neck shower for neck massage
 · A clear, broad gush spray
 · The natural form of the water is simulated
 · Flow rate: approx. 24 l/min at 3 bar

The planning examples

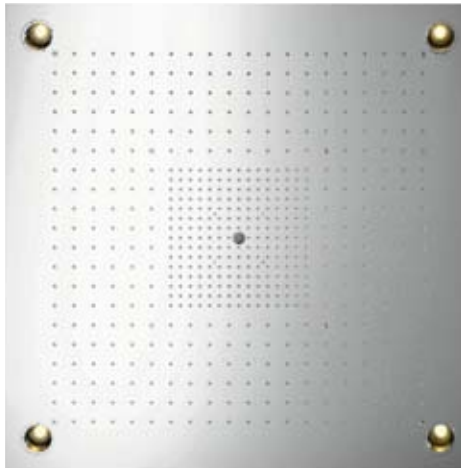

ShowerHeaven

Planning example 1: The shower for minimalists

This planning example embodies the dream shower of the designer Philippe Starck. All mixers and accessories are conventionally arranged vertically, and thus particularly ergonomically.

- Light and loudspeaker modules at eye and ear level
- Top shelf: practical for storing toiletries
- Shower modules in the neck and lumbar region are vertically adjustable so can be adjusted to different body sizes
- The central thermostat module controls the particular ideal temperature and the 3 different ShowerHeaven jet zones
- Hand shower module for direct access

Please see the installation manual from page 35 onwards for how to install this assortment of mixers and ShowerHeaven.



Light module



Speaker module



Shelf



Shower module



Shut-off valve



Thermostat module



Shower module



Handheld shower module



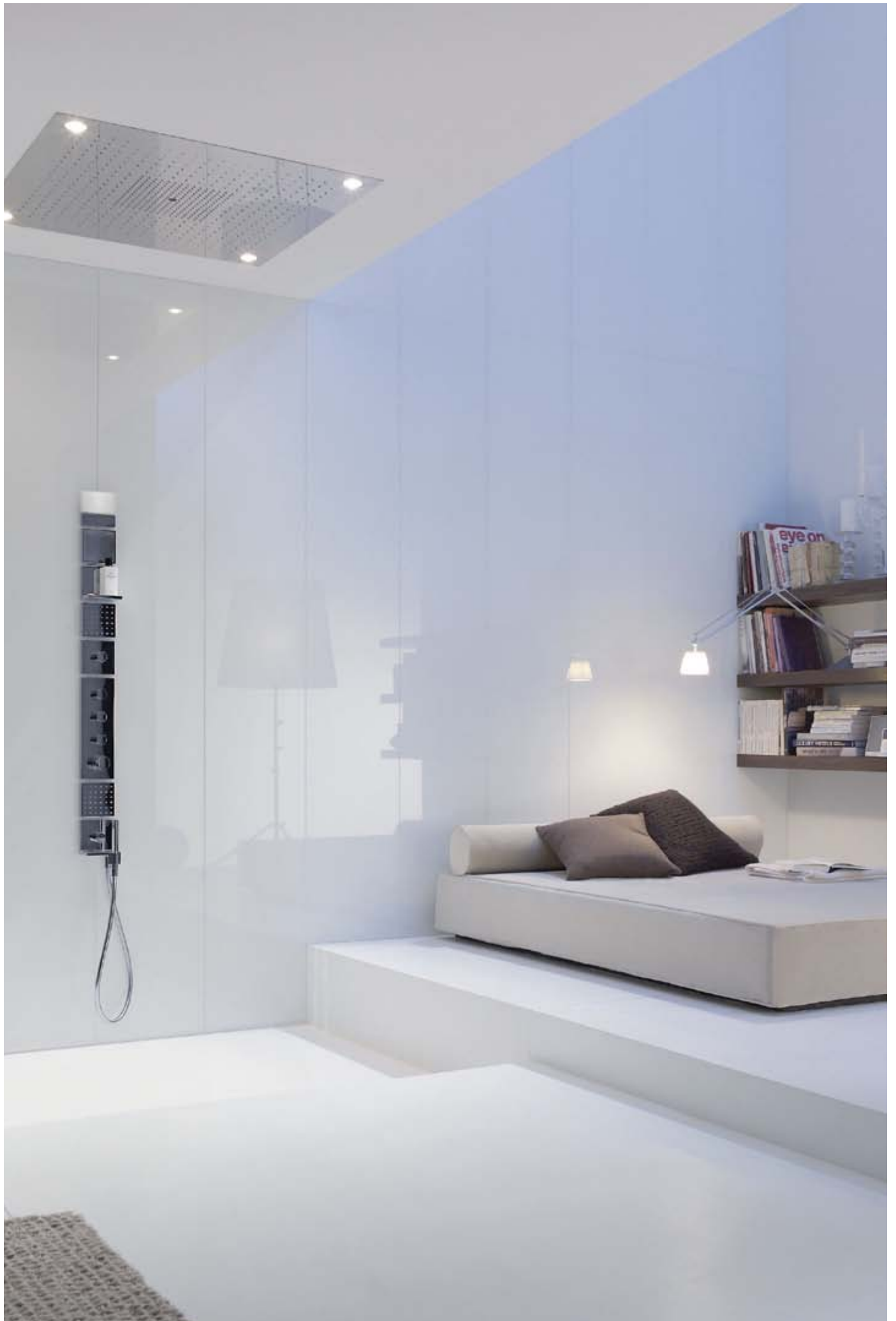

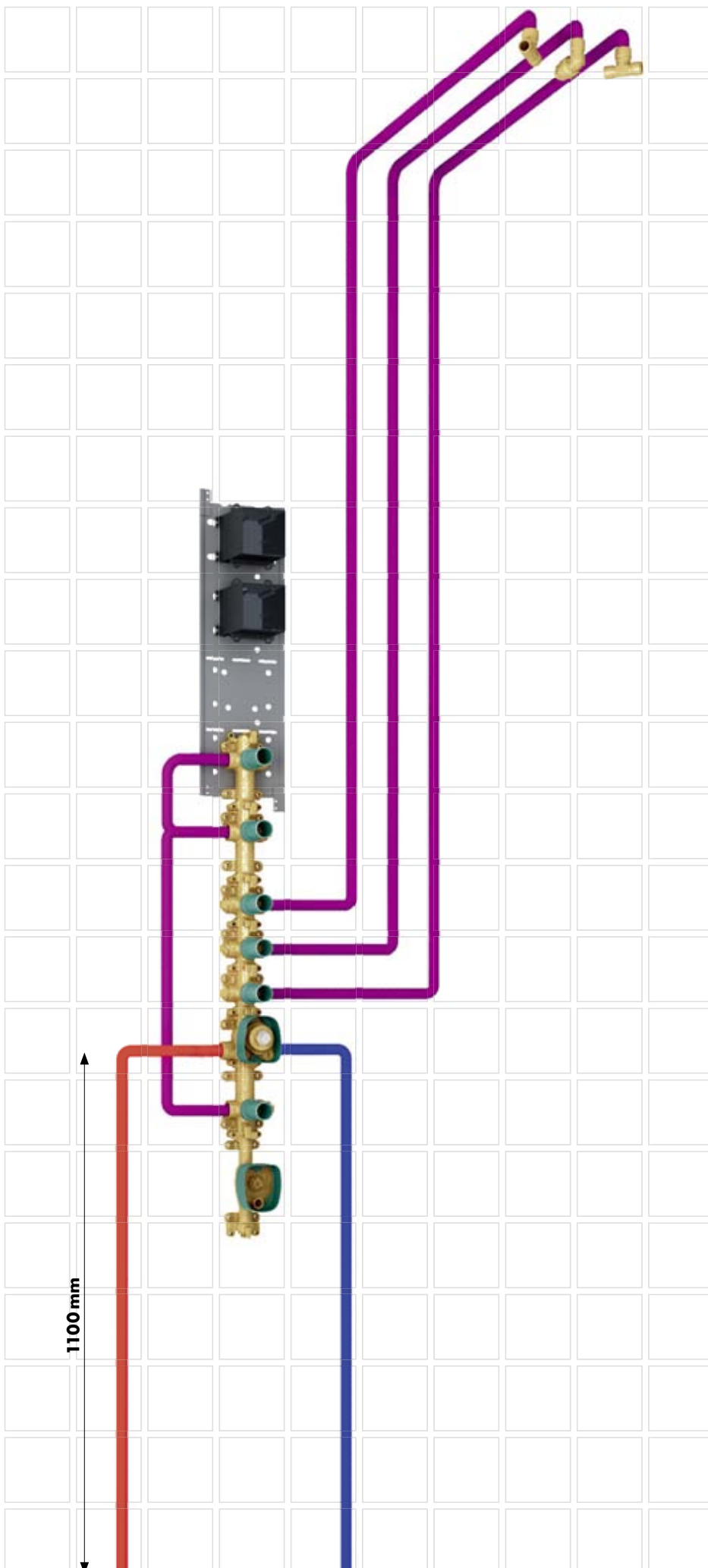

Axor products

1 x ShowerHeaven 97 x 97 with light
(inside wall installation)

Product no. 10623800

1 x Thermostat module 36 x 12 finish set

Product no. 10751000

1 x Basic set for thermostat module 36 x 12

Product no. 10750180

2 x Shower module 12 x 12 finish set

Product no. 28491000

2 x Basic set for shower module 12 x 12

Product no. 28486180

1 x Shut-off valve 12 x 12 finish set

Product no. 10972000

1 x Basic set for shut-off valve 12 x 12

Product no. 10971180

1 x Hand shower module 12 x 12 finish set

Product no. 10651000

1 x Basic set for hand shower module 12 x 12

Product no. 10650180

1 x Shelf 12 x 12

Product no. 40872000

1 x Loudspeaker module 12 x 12 finish set

Product no. 40874000

1 x Basic set for light/speaker module kit

Product no. 40876180

1 x Light module 12 x 12 finish set

Product no. 40871000

1 x Basic set for light/speaker module kit

Product no. 40876180

1 x Installation plate

Product no. 10973180

CEILING CONSTRUCTION

Lowered ceiling

To install the ShowerHeaven

Product no. 10623800

flush with the ceiling, you need an intermediate or lowered ceiling, made e. g. of gypsum board with a clearance of at least 8 cm.

You cannot install this system into concrete.

We recommend a square cutout of 950 mm.

The net weight of the ShowerHeaven without water is approx. 50 kg.

Attention: Not suitable for installation in hollow areas with flammable surrounding material.

SANITARY INSTALLATION for installation in compound

Warm water supply

Based on the individual showering preferences as well as on the number of users, the system must be dimensioned on an individual basis.

Working pressure of the fitting: max. 8 bar, recommended working pressure: 3–5 bar, hot water temperature: max. 60 °C, capacity recommendation: The hot water storage should be at least 300 l.

Attention: The ShowerHeaven cannot be used with combination boilers. Large differences in pressure between cold and hot water must be balanced.

Supply line

Product no. 10750180 basic set for thermostat module 36 x 12: 2 x G 3/4 (hot/cold); ShowerHeaven: 3 x G 3/4 (mixed water)

Thermostat module

Product no. 10751000 thermostat module 36 x 12, finish set with cylindrical handles and increased flow performance to control the ShowerHeaven. The basic set product no. 10750180 is required to install the thermostat module. Both items must be ordered separately. Free flow approx. 58 l/min at 3 bar.

Shower module

Product no. 28491000 shower module 12 x 12 finish set. To install (in one line – clearance 10 mm) use basic set product no. 28486180. Both items must be ordered separately. Flow rate approx. 9.8 l/min (for 2 shower modules) at 3 bar.

Shut-off valve

Product no. 10972000 shut-off valve 12 x 12 finish set for controlling both interconnected shower modules. To install (in one line – clearance 10 mm) use basic set product no. 10971180. Both items must be ordered separately. Free flow approx. 55 l/min at 3 bar.

Handheld shower module

Product no. 10651000 hand shower module 12 x 12 finish set. The basic set product no. 10650180 is required for installation. The shut-off valve is already integrated in the basic set of the hand shower module. Both items must be ordered separately. Flow rate approx. 17 l/min at 3 bar.

Shelf

Product no. 40872000 shelf 12 x 12.

Installation plate

We recommend the installation plate product no. 10973180 for optimal positioning (clearance 10 mm) of the light module, loudspeaker module and the shelf.

Speaker module

Product no. 40874000 loudspeaker module 12 x 12 finish set. The separate basic set product no. 40876180 is required. Both items must be ordered separately. To use the loudspeaker module as an active loudspeaker rather than a passive loudspeaker, the active module (A 403), which is available separately from the company DeToma GmbH (www.detoma.com), can also be connected. The loudspeaker is then optimally adapted to the acoustics via digital filters.

Light module

Product no. 40871000 light module 12 x 12 finish set. The separate basic set product no. 40876180 is required. Both items must be ordered separately.

DRAINING TECHNIQUE

Drain

Floor drain (without shower tray): Illbruck Poresta Slot, DN70 drain line; Alternative: Drain for shower tray: Raindrain 90 XXL, drain performance 51 l/min at 15 mm water depth (connecting line DN70), suited to be put into practice as per DIN 1247 1–3.

Raindrain 90 XXL complete set Product no. 60067000.

Attention: The drain performance must be large enough: > 50 l/min.

ELECTRICAL INSTALLATION Supply line

Supply line ShowerHeaven

3 x 1.5 mm² supply line; 1 x 4 mm² equipotential bonding Electric junction box and transformer included

Attention: ShowerHeaven must be installed higher 2.25 m.

Supply line to light module

3 x 1.5 mm² supply line transformer included

Attention:

- You must install an integrated socket for the transformer
- There must be an empty conduit installed to run the power supply (light)
- The electrical connection may only be installed by an electrician! Preinstall the power supply 230V/N/PE/50Hz. The fusing must be conducted via a fault power protection unit (RCD/FI) with a measuring differential power of < 30 mA. (not pictured)

Light switch for ShowerHeaven and light module

The light switch must be installed outside the shower area or switched via the ceiling light (outside the protection area 2 as per DIN VDE 100, part 701). The ShowerHeaven light and the light module are switched together in this case. (not shown)

Transformer ShowerHeaven

Secondary output voltage 12V/35–80VA

Transformer for light module

The cable length on the secondary side is 7 m. (not pictured) You will find a detailed description of the individual installation steps starting on page 35.

A detailed installation manual is enclosed with the respective products and can also be downloaded from our professional website on the internet. Precise flow calculations can subsequently also be carried out on this basis.

The planning examples

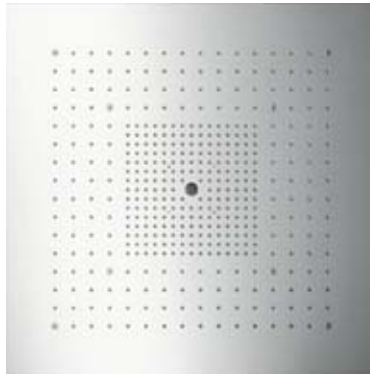

ShowerHeaven

Planning example 2: The deluxe versions

This shower concept horizontally combines all functional and shelving modules at an ergonomic height. All functions are comfortably feasible, and utensils are ready-to-hand.

- 4 shower modules can conveniently be used as a neck shower;
- 5 adjustment positions for problem-free adaptation to body size
- Thermostat module installed on the left-hand side with 3 integrated shut-off valves for controlling the ShowerHeaven
- Separate shut-off valve for joint control of the shower modules
- 24 cm wide shelf offers convenient space for shower utensils
- Side-mounted hand shower module easily accessible from the outside

Shower module

Thermostat module

Shut-off valve

Shelf

Handheld shower module





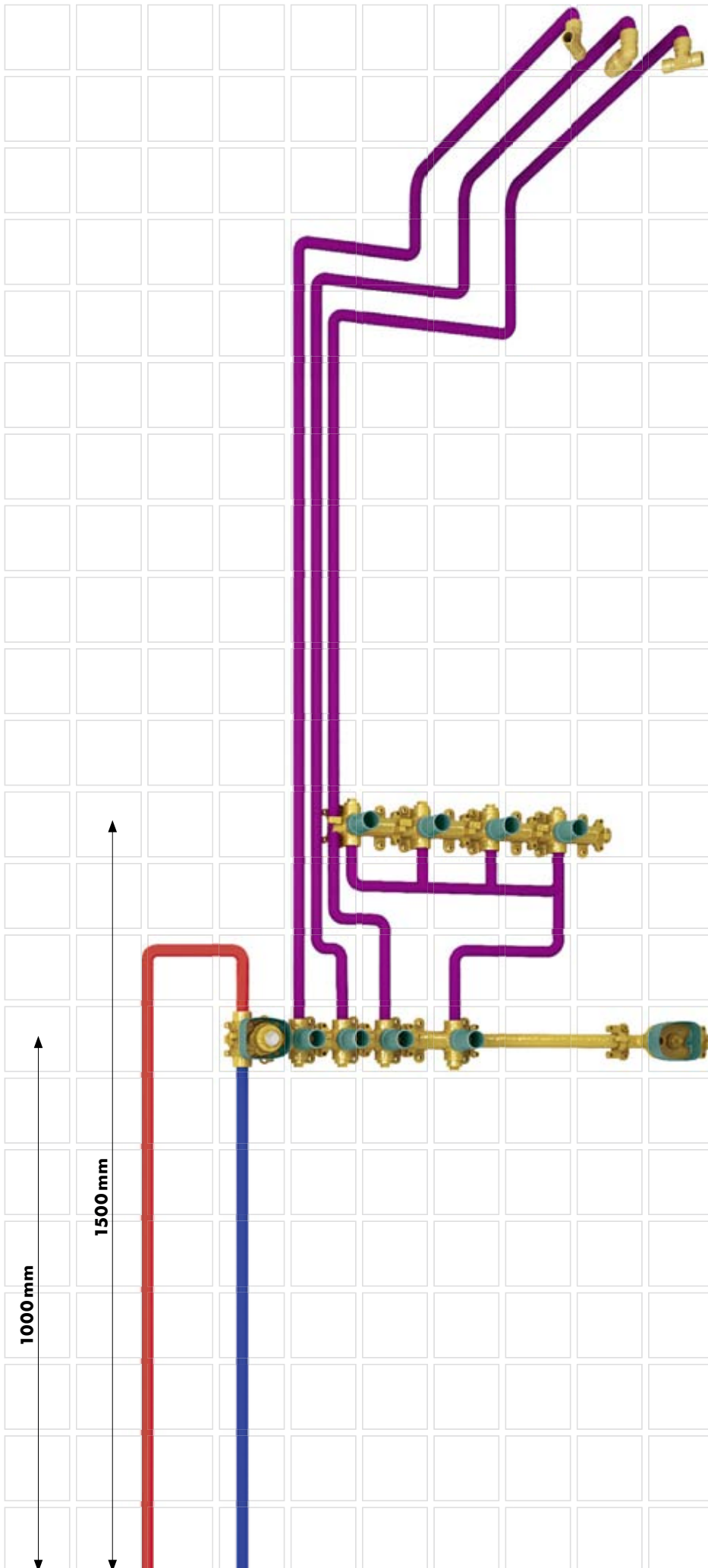

Axor products

1 x ShowerHeaven 72 x 72 without light
(exposed installation)

Product no. 10625800

1 x Thermostat module 36 x 12 finish set

Product no. 10751000

1 x Basic set for thermostat module 36 x 12

Product no. 10750180

4 x Shower module 12 x 12 finish set

Product no. 28491000

4 x Basic set for shower module 12 x 12

Product no. 28486180

1 x Shut-off valve 12 x 12 finish set

Product no. 10972000

1 x Basic set for shut-off valve 12 x 12

Product no. 10971180

1 x Hand shower module 12 x 12 finish set

Product no. 10651000

1 x Basic set for hand shower module 12 x 12

Product no. 10650180

1 x Shelf 24 x 12

Product no. 40873000

1 x Basic set for shelf 24 x 12

Product no. 40878180

CEILING CONSTRUCTION

Ceiling

The connecting lines to the ShowerHeaven Product no. 10625800 must be routed in the ceiling. The net weight of the ShowerHeaven without water is approx. 30 kg. The lowered ceiling must be large enough to carry the weight of the ShowerHeaven.

SANITARY INSTALLATION

Warm water supply

Based on the individual showering preferences as well as on the number of users, the system must be dimensioned on an individual basis. Working pressure of the fitting: max. 8 bar, recommended working pressure: 3-5 bar, hot water temperature: max. 60 °C, capacity recommendation: The hot water storage should be at least 300 l.

Attention: The ShowerHeaven cannot be used with combination boilers. Large differences in pressure between cold and hot water must be balanced.

Supply lines

Product no. 10750180 basic set for thermostat module 36 x 12:
2 x G 3/4 (hot/cold)
ShowerHeaven: 3 x G 3/4 (mixed water)
Shower modules: 1 x G 3/4 (mixed water)

Thermostat module

Product no. 10751000 thermostat module 36 x 12 finish set with cylindrical handles and increased flow performance to control the ShowerHeaven. The basic set product no. 10750180 is required to install the thermostat module. Both items must be ordered separately. Free flow approx. 58 l/min at 3 bar.

Shower module

Product no. 28491000 shower module 12 x 12 finish set. To install (in one line - clearance 10 mm) use basic set product no. 28486180. Both items must be ordered separately. Flow rate 19.5 l/min (for 4 shower modules) at 3 bar.

Shut-off valve

Product no. 10972000 shut-off valve 12 x 12 finish set for controlling the 4 shower modules. The shower modules are interconnected in the shower scene displayed. To install (in one line - clearance 10 mm) use basic set product no. 10971180. Both items must be ordered separately. Free flow approx. 55 l/min at 3 bar.

Handheld shower module

Product no. 10651000 hand shower module 12 x 12 finish set. The basic set product no. 10650180 is required for installation. The shut-off valve is already integrated in the basic set of the hand shower module. Both items must be ordered separately. Flow rate approx. 17 l/min at 3 bar.

Shelf

Product no. 40873000 shelf 24 x 12. Since the 24 x 12 shelf is installed between 2 water-carrying parts, the basic set product no. 40878180 is required as a water feed-through between shut-off valve and hand shower module.

DRAINING TECHNIQUE

Drain

Floor drain (without shower tray): Illbruck Poresta Slot, DN70 drain line; Alternative: Drain for shower tray: Raindrain 90 XXL, drain performance 51 l/min at 15 mm water depth (connecting line DN70), suited to be put into practice as per DIN 1247 1-3.

Raindrain 90 XXL complete set Product no. 60067000.

Attention: The drain performance must be large enough: > 50 l/min.

A detailed installation manual is enclosed with the respective products and can also be downloaded from our professional website on the internet. Precise flow calculations can subsequently also be carried out on this basis.

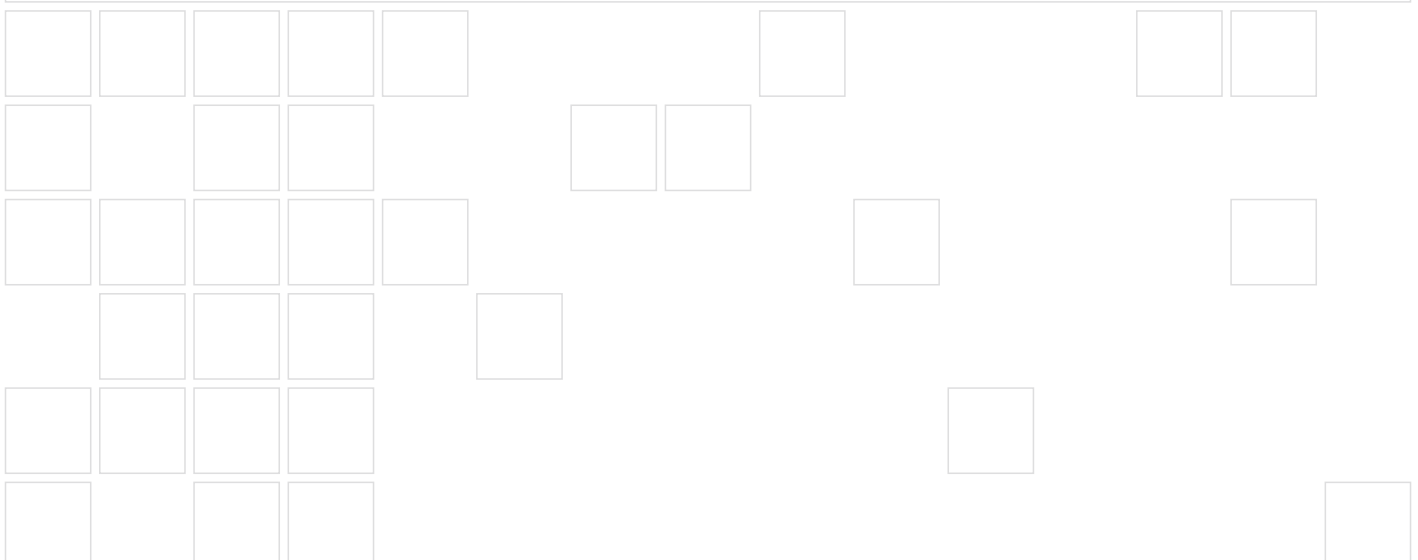

The planning examples



Planning example 3: The complete shower experience

The shower solution with 6 overhead shower modules and 6 body shower modules, installed in a corner, offers the complete water experience.

- The 6 overhead shower modules are centrally controlled via a shut-off valve in the thermostat module
- 6 other shower modules are arranged vertically and in a corner – these can be used in combinations of 3 or all together, depending on preference
- The functional modules for the overhead shower can be operated outside the wet area – water can be set to your ideal temperature before taking a shower
- The hand shower module is accessible from the walk-in area – ideal for cleaning the shower

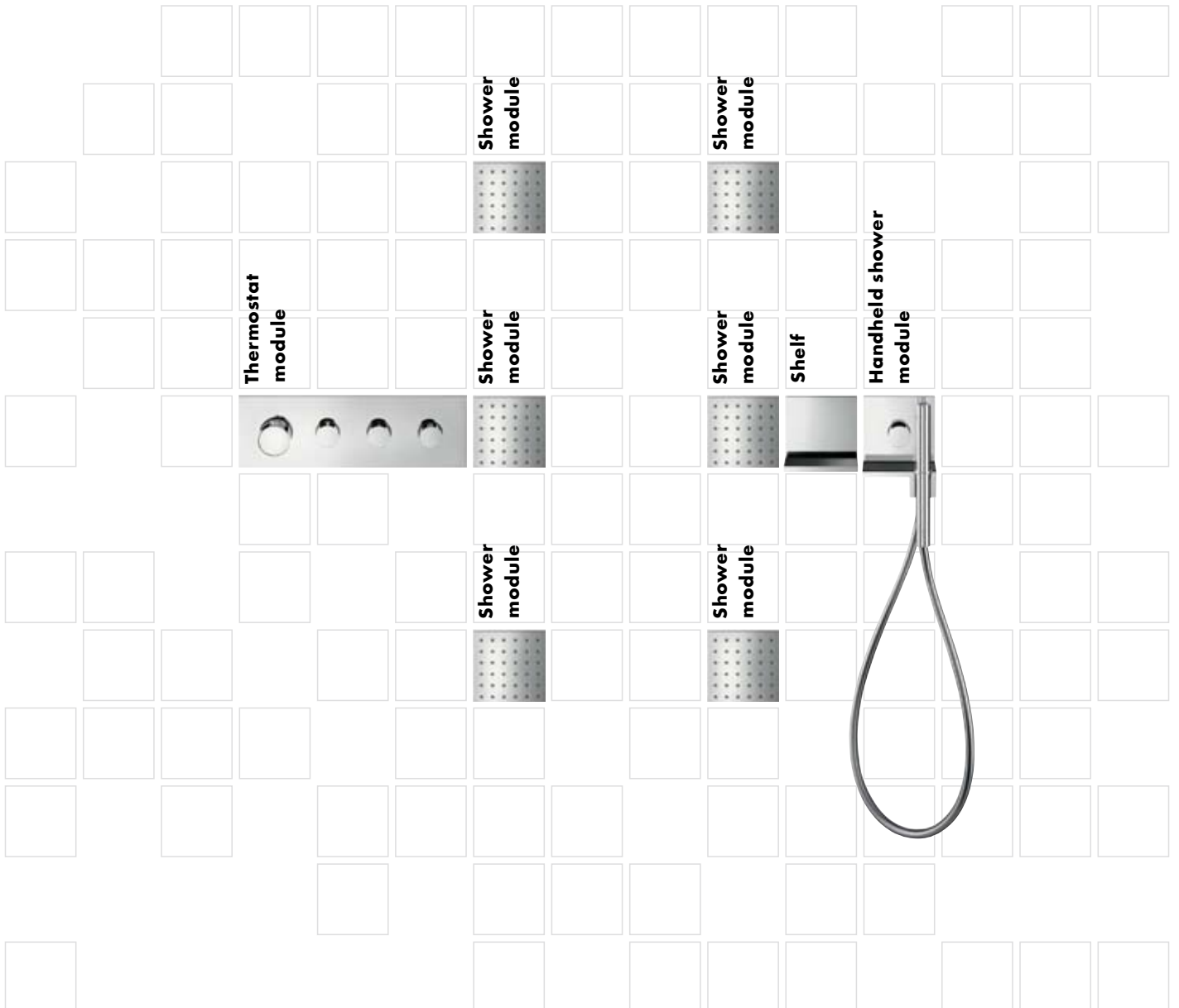
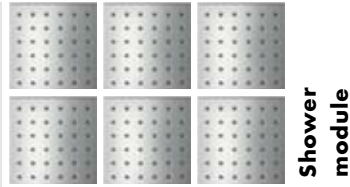



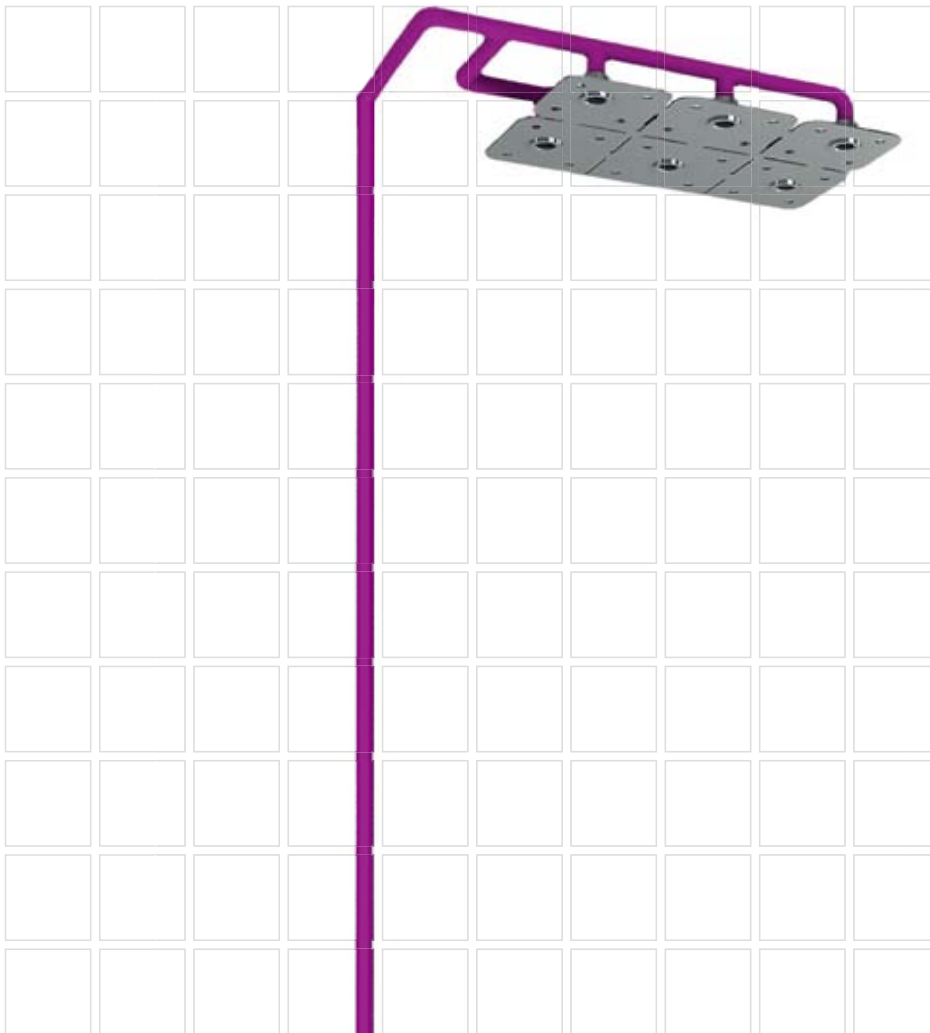

Axor products

For the overhead shower
6x Shower module 12 x 12 finish set

Product no. 28491000

1 x Installation plate

Product no. 28470180

For the body showers

6x Shower module 12 x 12 finish set

Product no. 28491000

2x Basic set for shower module 12 x 12

Product no. 28486180

1 x Thermostat module 36 x 12 finish set

Product no. 10751000

1 x Basic set for thermostat module 36 x 12

Product no. 10750180

1 x Shelf 12 x 12

Product no. 40872000

1 x Basic set for shelf 12 x 12

Product no. 40877180

1 x Hand shower module 12 x 12 finish set

Product no. 10651000

1 x Basic set for hand shower module 12 x 12

Product no. 10650180

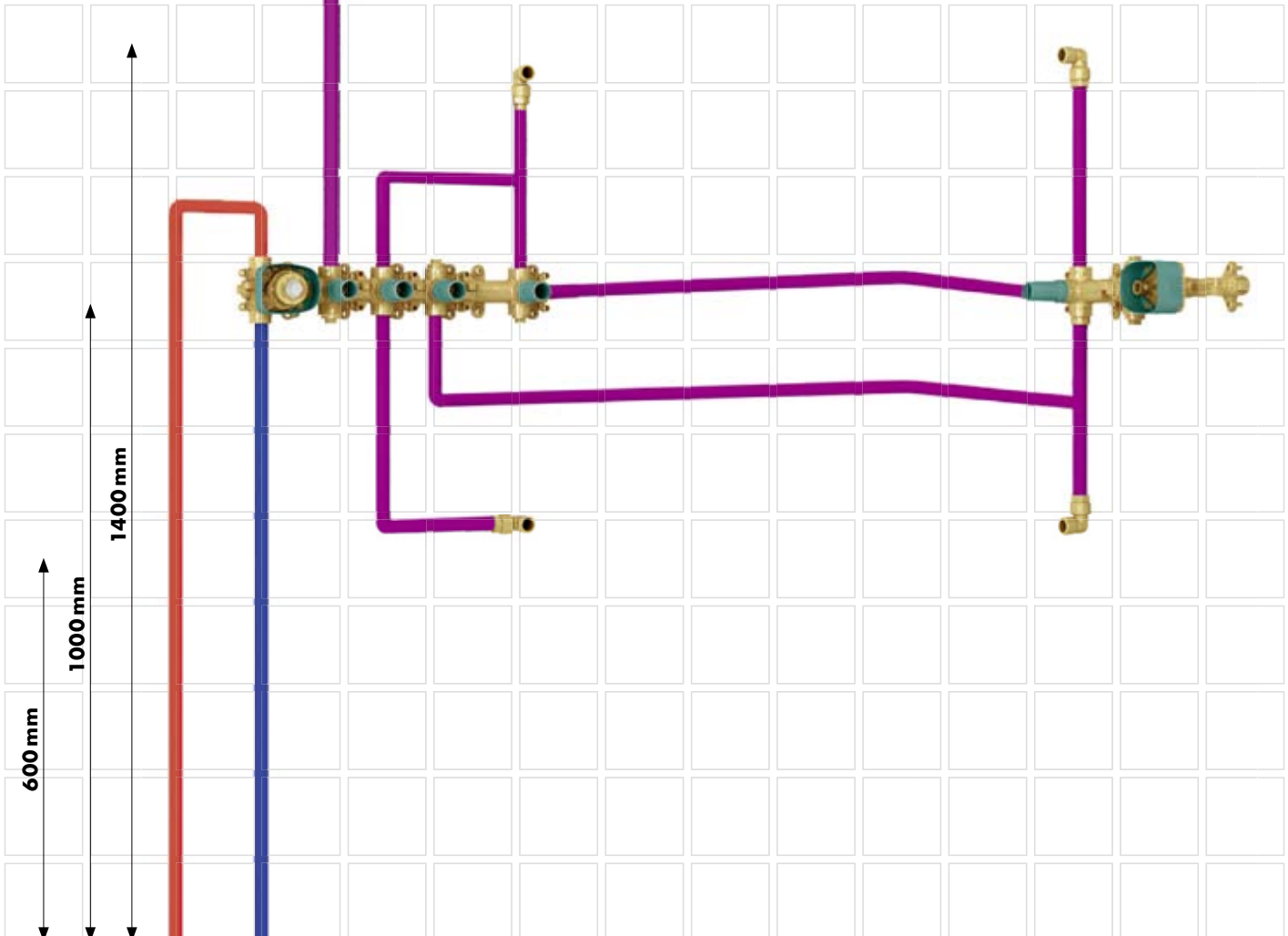

CEILING CONSTRUCTION

Lowered ceiling

To install the shower modules, the connection cables must be routed in the ceiling. To install the 6 shower modules correctly in the ceiling, we recommend using the installation plate, product no. 28470180.

SANITARY INSTALLATION for free installation

Warm water supply

Based on the individual showering preferences as well as on the number of users, the system must be dimensioned on an individual basis. Working pressure of the fitting: max. 8 bar, recommended working pressure: 3-5 bar, hot water temperature: max. 60 °C, capacity recommendation: The hot water storage should be at least 300 l.

Attention: The product cannot be used in conjunction with continuous flow heaters. Significant differences in pressure between the cold and hot water connections must be compensated.

Supply lines

Product no. 10750180 basic set for thermostat module 36 x 12:

2 x G 3/4 (hot/cold)

Shower modules in the ceiling: 1 x G 3/4 (mixed water)

Shower modules in the wall: G 1/2 (mixed water)

Thermostat module

Product no. 10751000 thermostat module 36 x 12 finish set with cylindrical handles with increased flow performance to control the shower modules in the ceiling and on the wall. The basic set product no. 10750180 is required to install the thermostat module. Both items must be ordered separately. Free flow approx. 58 l/min at 3 bar.

Shower module (wall installation)

Product no. 28491000 shower module 12 x 12 finish set for wall installation. The 3 shower modules positioned on the left can be operated separately from the 3 on the right. They are controlled via the thermostat module. To install (in one line - clearance 10 mm) use basic set product no. 28486180. Shower modules not installed together with other basic sets can be installed using a standard G 1/2 wall connection. Flow rate approx. 24.5 l/min (with 6 shower modules) at 3 bar.

Handheld shower module

Product no. 10651000 hand shower module 12 x 12 finish set. The basic set product no. 10650180 is required for installation. The shut-off valve is already integrated in the basic set of the hand shower module. Both items must be ordered separately. Flow rate approx. 17 l/min at 3 bar.

Shelf

Product no. 40872000 shelf 12 x 12. Since the shelf 12 x 12 is installed between 2 water-carrying parts, the basic set product no. 40877180 is required as a water feed-through between shower module and hand shower module.

DRAINING TECHNIQUE

Drain

Floor drain (without shower tray): Illbruck Poresta Slot, DN70 drain line; Alternative: Drain for shower tray: Raindrain 90 XXL, drain performance 51 l/min at 15 mm water depth (connecting line DN70), suited to be put into practice as per DIN 1247 1-3.

Raindrain 90 XXL complete set Product no. 60067000.

Attention: The drain performance must be large enough: > 50 l/min.

A detailed installation manual is enclosed with the respective products and can also be downloaded from our professional website on the internet. Precise flow calculations can subsequently also be carried out on this basis.

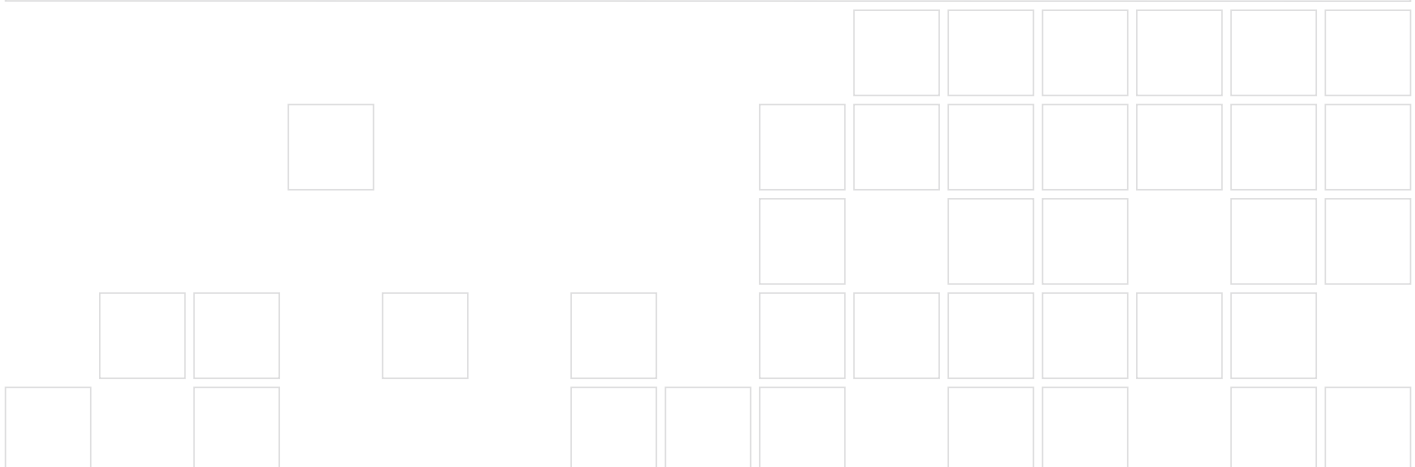

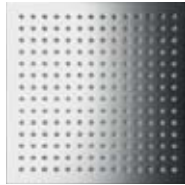

Overhead shower



Shut-off valve

**Thermostat module
Shelf**

**Handheld
shower module**

**Planning example 4:
Showering in a smaller space**

With its compact 24 x 24 overhead shower, the Axor ShowerCollection offers a convenient solution for small bathrooms too.

- Separate temperature control via a thermostatic module 12 x 12
- Shut-off valve above the thermostat regulates the control for the overhead shower
- Shut-off valve below the thermostat with hose connection controls the integrated hand shower
- 2 shelves provide space for toiletries





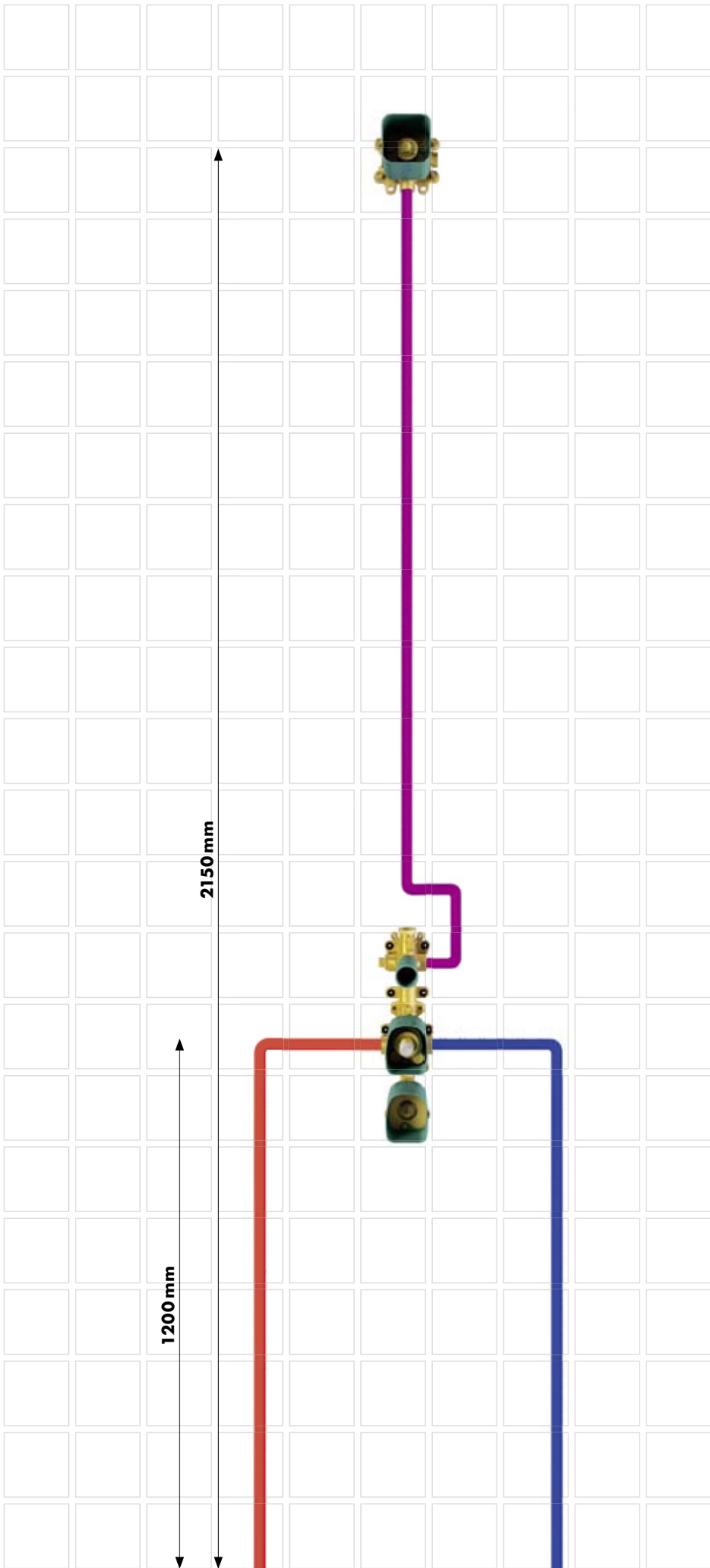

Axor products

1 x Overhead shower 24 x 24
with shower arm

Product no. 10925000

1 x Basic set for overhead shower 24 x 24

Product no. 10921180

1 x Thermostat module 12 x 12 finish set

Product no. 10755000

1 x Basic set for thermostat module 12 x 12

Product no. 10754180

1 x Shut-off valve 12 x 12 finish set

Product no. 10972000

1 x Basic set for shut-off valve 12 x 12

Product no. 10971180

1 x Hand shower module 12 x 12 finish set

Product no. 10651000

1 x Basic set for hand shower module 12 x 12

Product no. 10650180

2 x Shelf 12 x 12

Product no. 40872000

WALL INSTALLATION

Wall

The basic set product no. 10921180 is used to install the overhead shower 24 x 24 product no. 10925000 quickly and professionally. Taking into account the projection and the weight, this ensures that the overhead shower is mounted securely and perfectly aligned to the wall (basic set is not included in the scope of delivery of the overhead shower).

Attention: The net weight of the shower without water is 6.7 kg. Please provide an adequate wall reinforcement at this point for the basic set.

The thermostat module 12 x 12 finish set product no. 10755000 or product no. 10754180 (basic set) in conjunction with a separate shut-off valve 12 x 12 finish set product no. 10972000 or product no. 10971180 (basic set) is ideal for controlling the overhead shower 24 x 24.

Attention: In order to guarantee that the shower functions correctly, the mixer must be installed, rinsed and tested in accordance with the applicable standards!

SANITARY INSTALLATION

Warm water supply

Based on the individual showering preferences as well as on the number of users, the system must be dimensioned on an individual basis. Working pressure of the fitting: max. 8 bar, recommended working pressure: 3-5 bar, hot water temperature: max. 60 °C, capacity recommendation: The hot water storage should be at least 300 l.

Attention: The overhead shower 24 x 24 cannot be used in conjunction with continuous flow heaters. Significant differences in pressure between the cold and hot water connections must be compensated.

Supply lines

Product no. 10754180 basic set for thermostat module 12 x 12: 2 x G 3/4 (hot/cold)

Product no. 10921180 basic set for overhead shower 24 x 24: 1 x G 1/2 (mixed water)

Thermostat module

Product no. 10755000 thermostat module 12 x 12 finish set with increased flow performance; free flow: 58 l/min at 3 bar.

Product no. 10754180, basic set for thermostat module 12 x 12. Both items must be ordered separately.

Shut-off valve

Product no. 10972000 shut-off valve 12 x 12 finish set. Required for controlling the overhead shower. To install (in one line - clearance 10 mm) use basic set product no. 28486180. Both items must be ordered separately. Free flow approx. 55 l/min at 3 bar.

Handheld shower module

Product no. 10651000 hand shower module 12 x 12 finish set. The basic set product no. 10650180 is required for installation. The shut-off valve is already integrated in the basic set of the hand shower module. Both items must be ordered separately. Flow rate approx. 17 l/min at 3 bar.

Shelf

Product no. 40872000 shelf 12 x 12.

A loudspeaker module product no. 40874000 and/or light module product no. 40871000 can optionally be installed in conjunction with the overhead shower, with a clearance of 10 mm. The separate basic set product no. 40876180 is required to install the loudspeaker and light module. We recommend the installation plate product no. 10973180 for optimal positioning (clearance 10 mm) of the light module, loudspeaker module and the shelf. To use the loudspeaker module as an active loudspeaker rather than a passive loudspeaker, the active module (A 403), which is available separately from the company DeToma GmbH (www.detoma.com), can also be connected. The loudspeaker is then optimally adapted to the acoustics via digital filters.

DRAINING TECHNIQUE

Drain

Floor drain (without shower tub): Illbruck Poresta Slot, drain line DN70; Alternative: Drain for shower tub: Raindrain 90 XXL, drain performance 51 l/min at 15 mm water level (connection cable DN70), designed for practical application as per DIN 1247 1-3.

Raindrain 90 XXL complete set product no. 60067000.

Attention: The drain performance must be large enough: > 50 l/min.

A detailed installation manual is enclosed with the respective products and can also be downloaded from our professional website on the internet. Precise flow calculations can subsequently also be carried out on this basis.

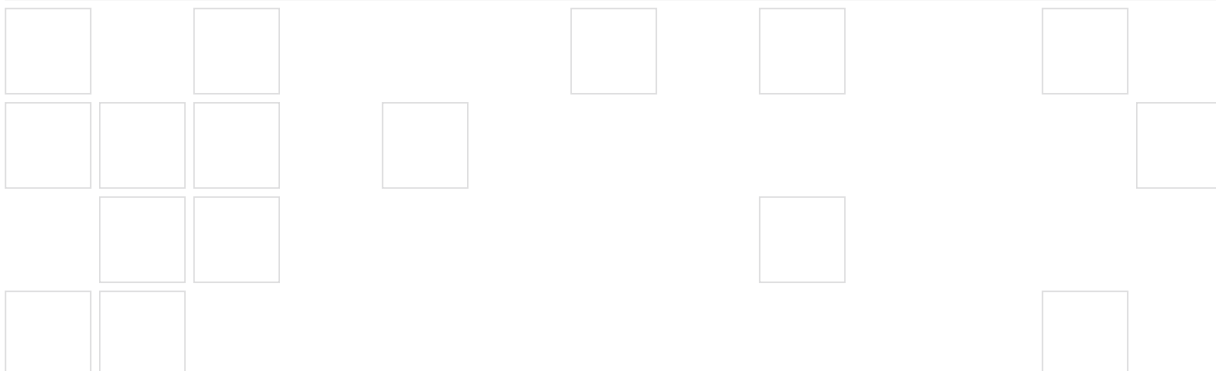

The planning examples

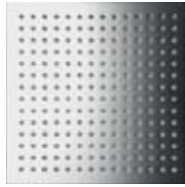

Overhead shower

Planning example 5: The walk-in shower

In the walk-in solution, the shower elements can be controlled from outside the wet area without any problem.

- Overhead and flood shower for your own personal spa
- Thermostat and shut-off valve for controlling the showers are easy to operate from the outside
- Space for shower utensils on the shelves or on the waterfall spout

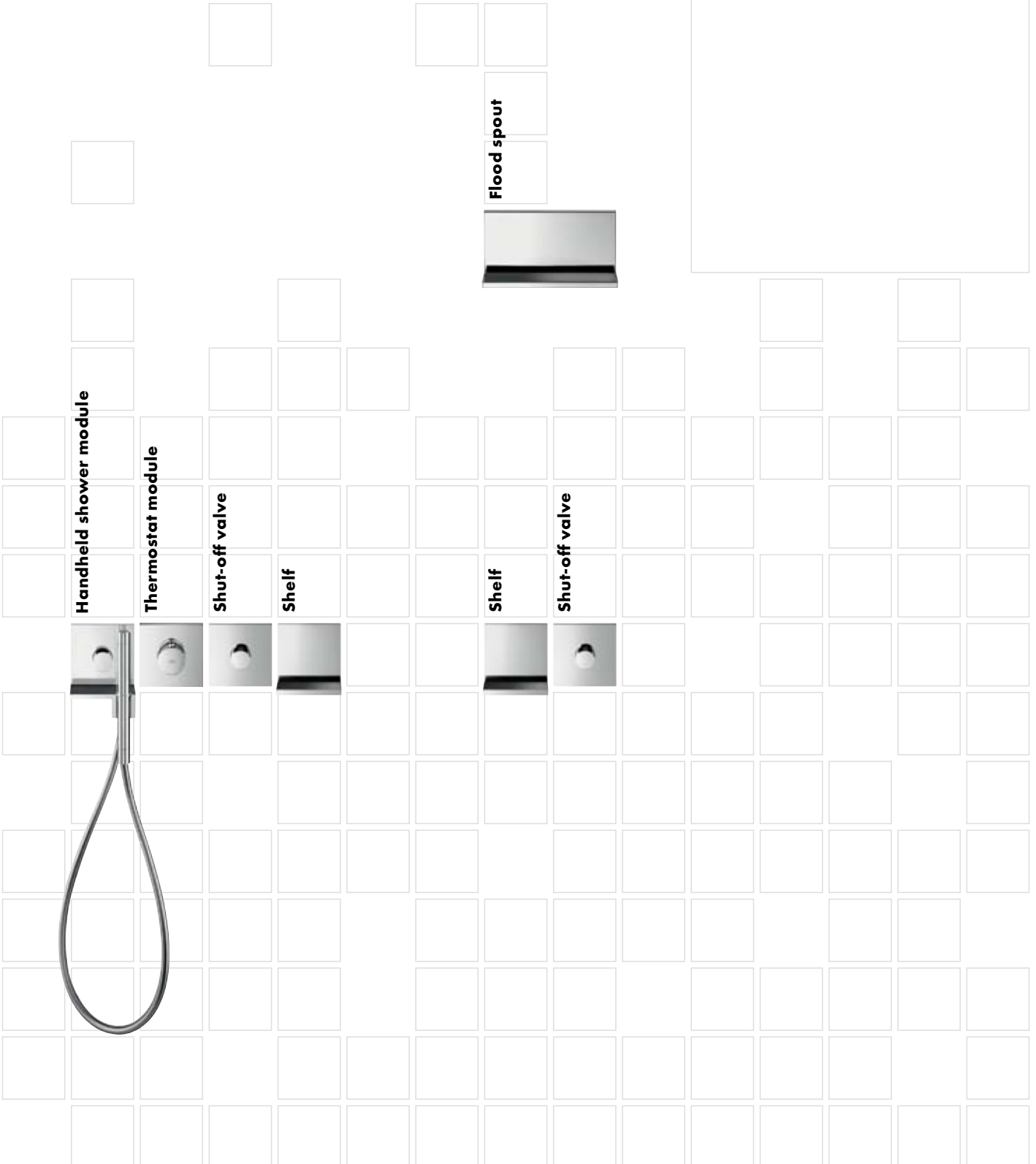



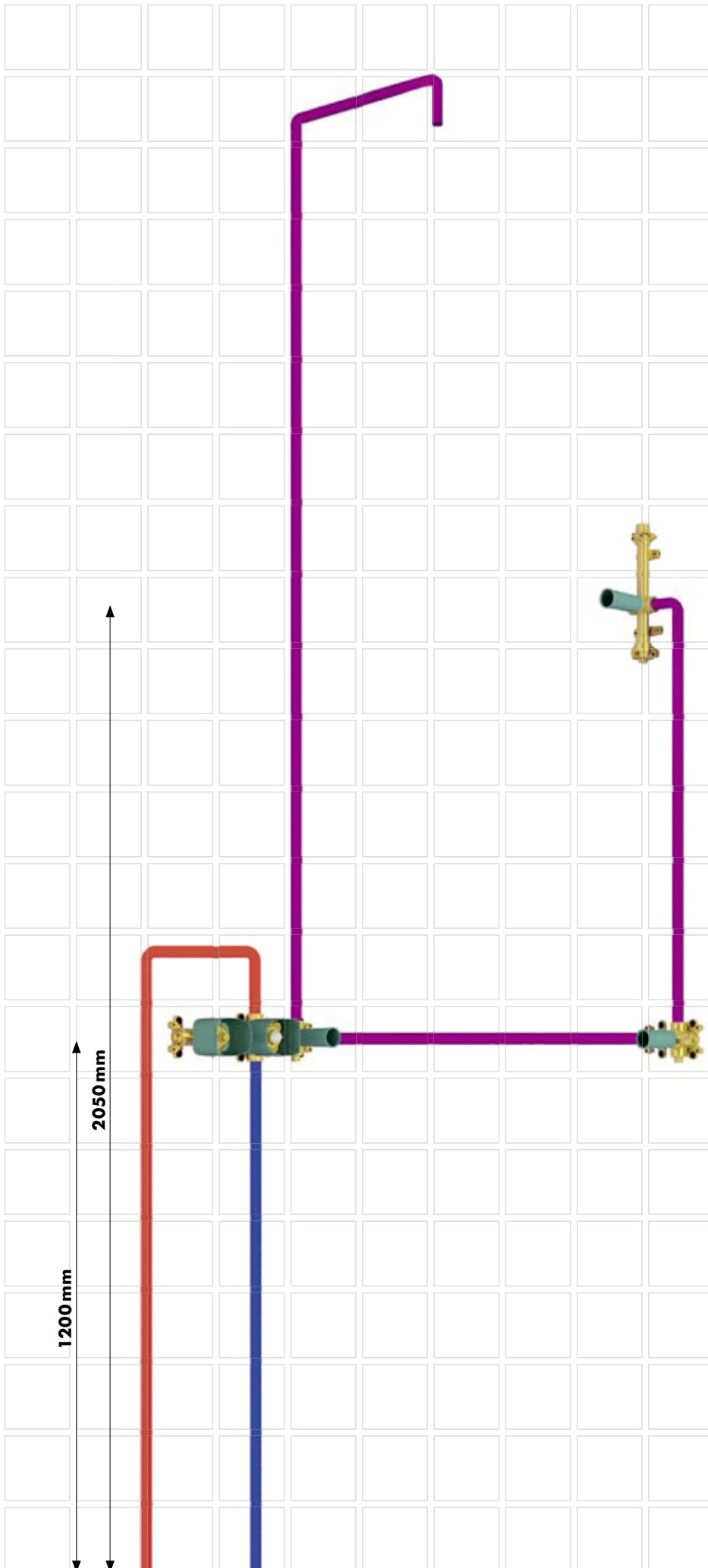

Axor products

1 x Overhead shower 24 x 24 with ceiling connector

Product no. 10929000

1 x Waterfall spout 24 x 12 finish set

Product no. 10942000

1 x Basic set for waterfall spout 24 x 12

Product no. 10941180

1 x Thermostat module 12 x 12 finish set

Product no. 10755000

1 x Basic set for thermostat module 12 x 12

Product no. 10754180

2 x Shut-off valve 12 x 12 finish set

Product no. 10972000

2 x Basic set for shut-off valve 12 x 12

Product no. 10971180

1 x Hand shower module 12 x 12 finish set

Product no. 10651000

1 x Basic set for hand shower module 12 x 12

Product no. 10650180

2 x Shelf 12 x 12

Product no. 40872000

CEILING CONSTRUCTION

Ceiling connector

To install the overhead shower 24 x 24 product no. 10929000, the connection fitting, included in the scope of delivery, must firstly be screwed into a G 1/2 internal thread. The metal ceiling connector (length 126 mm) is then attached to the connection fitting and fixed with screws. Then the overhead shower is screwed tightly onto the ceiling connector.

Attention: Net weight of the shower without water: 4.5 kg.
Please provide an adequate ceiling reinforcement at this point.

The thermostat module 12 x 12 finish set product no. 10755000 or product no. 10754180 (basic set) in conjunction with a separate shut-off valve 12 x 12 finish set product no. 10972000 or product no. 10971180 (basic set) is ideal for controlling the overhead shower 24 x 24.

Attention: In order to guarantee that the shower functions correctly, the mixer must be installed, rinsed and tested in accordance with the applicable standards!

SANITARY INSTALLATION

Warm water supply

The system's dimensions must be determined on an individual basis, based on personal showering tastes, frequency of use and the number of other users. Working pressure of the mixer: max. 8 bar, recommended working pressure: 3–5 bar, hot water temperature: max. 60 °C, capacity recommendation: the hot water storage should be at least 300 l.

Attention: The overhead shower 24 x 24 cannot be used in conjunction with continuous flow heaters. Significant differences in pressure between the cold and hot water connections must be compensated.

Supply lines

Product no. 10754180 basic set for thermostat module 12 x 12:
2 x G 3/4 (hot/cold)

Product no. 10921180 basic set for overhead shower 24 x 24:
1 x G 1/2 (mixed water)

Thermostat module

Product no. 10755000 thermostat module 12 x 12 finish set with increased flow performance; free flow: 58 l/min at 3 bar.

Product no. 10754180, basic set for thermostat module 12 x 12.
Both items must be ordered separately.

Flood spout

Product no. 10942000 waterfall spout 24 x 12 finish set. The waterfall spout is installed as a flood shower in this case. It can be installed with or without basic set for waterfall spout 24 x 12 product no. 10941180. In the case of an installation without basic set, a G 3/4 internal thread connection must be provided. The waterfall spout is controlled via the thermostat module 12 x 12 finish set product no. 10755000 or product no. 10754180 (basic set) in conjunction with a separate shut-off valve 12 x 12 finish set product no. 10972000 or product no. 10971180 (basic set).

Shut-off valve

Product no. 10972000 shut-off valve 12 x 12 finish set. 1 x shut-off valve G 3/4 is required to control the overhead shower. 1 x shut-off valve G 3/4 is required to control the waterfall spout. To install (in one line – clearance 10 mm) use basic set product no. 28486180. Both items must be ordered separately. Free flow approx. 55 l/min at 3 bar.

Handheld shower module

Product no. 10651000 hand shower module 12 x 12 finish set. The basic set product no. 10650180 is required for installation. The shut-off valve is already integrated in the basic set of the hand shower module. Both items must be ordered separately. Flow rate approx. 17 l/min at 3 bar.

Shelf

Product no. 40872000 shelf 12 x 12 (2 pieces).

DRAINING TECHNIQUE

Drain

Floor drain (without shower tray): Illbruck Poresta Slot, DN70 drain line; Alternative: Drain for shower tray: Raindrain 90 XXL, drain performance 51 l/min at 15 mm water depth (connecting line DN70), suited to be put into practice as per DIN 1247 1–3.

Raindrain 90 XXL complete set Product no. 60067000.

Attention: The drain performance must be large enough: > 50 l/min.

A detailed installation manual is enclosed with the respective products and can also be downloaded from our professional website on the internet. Precise flow calculations can subsequently also be carried out on this basis.

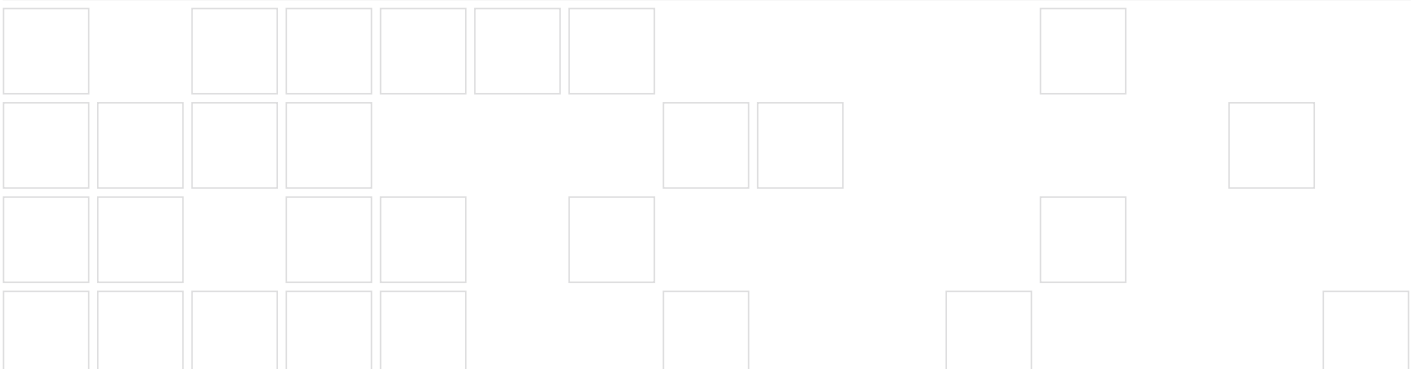





**Planning example 6:
Bath tub solution with waterfall
spout**

The Axor ShowerCollection is ideal for designing a bath tub setting, e.g. in a hotel bathroom.

- The hand shower module is installed on the left-hand wall - easily accessible for cleaning the bath tub
- Thermostat module for the temperature control and hand shower module is easily accessible from outside the bath tub
- Shut-off valve controls the adjoining waterfall spout
- Waterfall spout also serves as a shelf for toiletries

Handheld shower module

Thermostat module

Flood spout

Shut-off valve

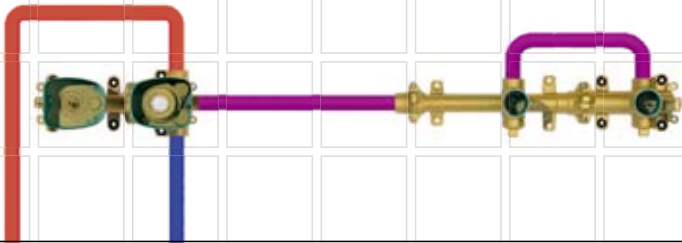
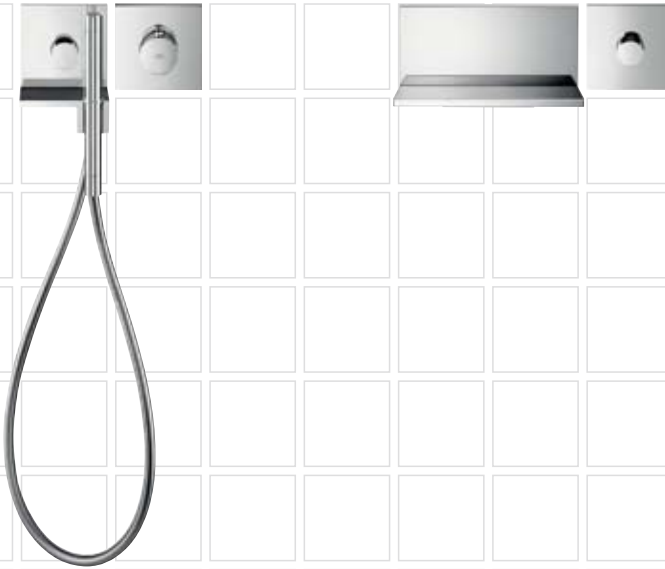

200 mm

Tub rim

Axor products

1 x Thermostat module 12 x 12 finish set

Product no. 10755000

1 x Basic set for thermostat module 12 x 12

Product no. 10754180

1 x Hand shower module 12 x 12 finish set

Product no. 10651000

1 x Basic set for hand shower module 12 x 12

Product no. 10650180

1 x Shut-off valve 12 x 12 finish set

Product no. 10972000

1 x Basic set for shut-off valve 12 x 12

Product no. 10971180

1 x Waterfall spout 24 x 12 finish set

Product no. 10942000

1 x Basic set for waterfall spout 24 x 12

Product no. 10941180

SANITARY INSTALLATION

Supply lines

Product no. 10754180 basic set for thermostat module 12 x 12:

2 x G $\frac{3}{4}$ (hot/cold)

Thermostat module

Product no. 10755000 thermostat module 12 x 12 finish set with increased flow performance; free flow: 58 l/min at 3 bar. Product no. 10754180, basic set for thermostat module 12 x 12. Both items must be ordered separately.

Flood spout

Product no. 10942000 waterfall spout 24 x 12 finish set. The waterfall spout is installed as a bath filler in this case. The projection of the waterfall spout is 180mm. This dimension must be taken into consideration when selecting the bath tub, so that the flood spray protrudes over the bath tub rim in any event. Here, the waterfall spout must be installed with the basic set for waterfall spout product no. 10941180, to guarantee accurate installation with a clearance of 10 mm to the directly adjacent shut-off valve. The waterfall spout is controlled via the thermostat module 12 x 12 finish set product no. 10755000 or product no. 10754180 (basic set) in conjunction with a separate shut-off valve 12 x 12 finish set product no. 10972000 or product no. 10971180 (basic set).

Shut-off valve

Product no. 10972000 shut-off valve 12 x 12 finish set. To install (in one line - clearance 10 mm) use basic set product no. 28486180. Both items must be ordered separately. Free flow approx. 55 l/min at 3 bar.

Handheld shower module

Product no. 10651000 hand shower module 12 x 12 finish set. The basic set product no. 10650180 is required for installation. The shut-off valve is already integrated in the basic set of the hand shower module. Both items must be ordered separately. Flow rate approx. 17 l/min at 3 bar.

A detailed installation manual is enclosed with the respective products and can also be downloaded from our professional website on the internet. Precise flow calculations can subsequently also be carried out on this basis.

The modular principle

THE SOPHISTICATED MODULAR PRINCIPLE

Due to the joined installation, special basic sets are used for optimum mounting. These enable the individual modules to be installed accurately in a perfect line.

- The basic sets can be easily inserted into each other
- The finish sets are installed using defined clearances (10 mm)
- No distortion or detaching of the basic sets - thanks to cotter pins
- Flow of water inside the basic sets

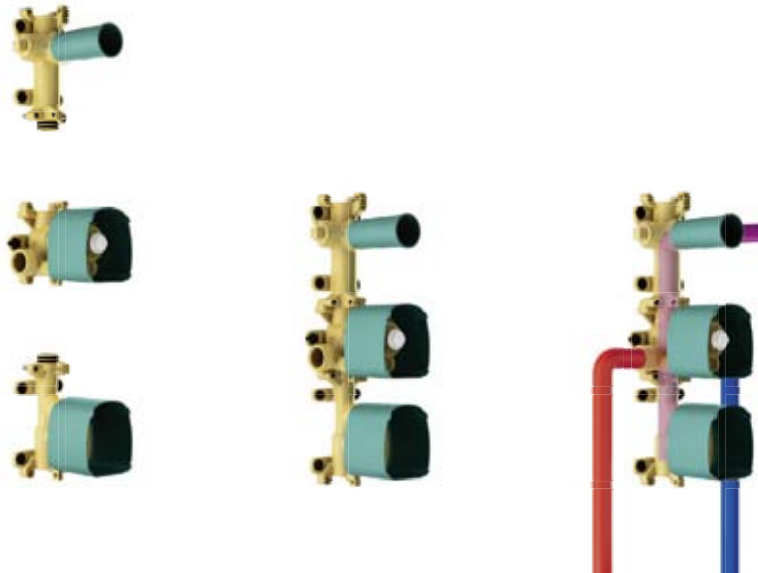

The installations

Mixers/shower modules/accessories installation path in a vertical line

Below we explain how to install the mixers, the shower modules and the accessories from Planning Example 1 in a vertical line.

01

Unscrew the preinstalled plugs from the top and bottom of the basic thermostat module kit.



02

Install the basic shut-off valve kit at the top of the basic thermostat module kit and secure with locking pins.



03

Install the basic shower module kit at the top of the basic shut-off valve kit and secure with locking pins.



04

Install the basic shower module kit at the bottom of the basic thermostat module kit and secure with locking pins.



05

Install the basic handheld shower module kit at the bottom of the basic shower module kit and secure with locking pins.



The installations

06

Screw in plugs in the shown positions.

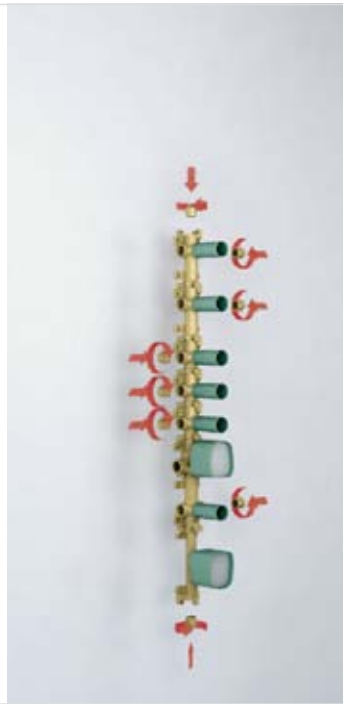

07

Attach the installation plate to the basic shower module kit from behind. Screw the integrated wall sockets for the speaker and light modules to the installation plate.



08

Align the preinstalled basic kit in the unfinished wall and affix.



09

The fitting must be piped, flushed and tested. Cementing the basic kit into the wall surface. Fill the seams with silicone.

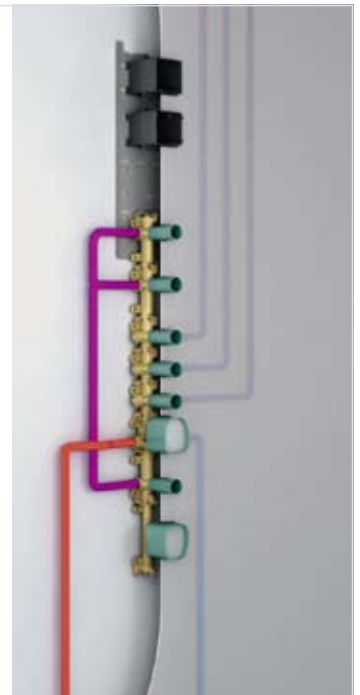

10

Install a sealing collar and press into the glue and the silicone below.



11

Cut all construction protection pieces off 1 mm in front of the tiles.



12

Screw in the threaded sleeves and shorten to 13 mm from the wall. All elements must now be sealed with silicone towards the wall.

**13**

Insert the threaded adapter and shorten to 25 mm from the wall surface.

**14**

Remove the flushing block and install the thermostat control unit into the basic thermostat module kit. Install and fasten the threaded adapter and the handle stop. Install the chrome-plated sleeve.

**15**

Install the cover plate of the thermostat module.

**16**

Screw the three handle sleeves onto the threaded sleeve kit of the thermostat module and then insert the handles. Install the thermostat handle and tighten the fastening screws.

**17**

Screw the handle sleeve onto the threaded sleeve kit of the shut-off valve and then attach the handle.



The installations

18

Preinstall the water guide of the handheld shower module. Install the preinstalled unit and screw the handle sleeve onto the threaded sleeve kit of the handheld shower module. Then install the handle.



19

Screw the G 1/2 connection into the connection of the shower module basic set. Then fix the shower module cartridge onto the G 1/2 connection. Then mount the covering plate on the cartridge and fix in place with Allen screws.



20

Align the borings for the shelf by means of a drilling template. Install the fixation plate on the wall. Install the shelf on the fixation plate.



21

Install the speakers and secure them to the basic set using four screws. Then install the cover.



22

Route a secondary line from the transformer to the basic kit. Connect the plugs, light unit and the secondary cable. Insert the light unit and fasten using 4 screws. After that preadjust the ready to use kit using grub bolts and then hook them in and secure them.



23

Perform a functional test.



Installation path of the shower modules for ceiling installation.

In addition to their installation for a body or a neck shower, the shower module can also be used with several others as a head shower. In this case, 6 shower modules are combined.

01

Align the installation plate with the 6 shower modules.



02

Pipe the connectors and install the threaded bars into the ceiling to secure the installation plate.



03

Hold the installation plate with the piping against the desired location on the ceiling and screw it on using the threaded bars and align it. After that, check the lines for leaks.

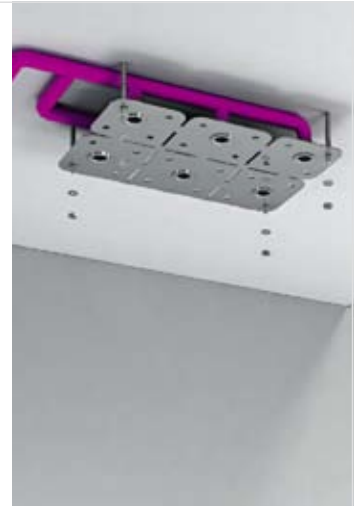

04

Install intermediate ceiling and prepare 6 screw holes for the G 1/2 connections. Then screw the G 1/2 connections into the installation plate.



05

Align the shower modules with the flat side of the G 1/2 connection.



06

Secure the shower module cartridges to the G 1/2 connections. Then install the covering plate on the cartridge and secure by loosening the Allen screws.



07

Perform a functional test.



The installations

ShowerHeaven installation path

This installation path explains the installation of the ShowerHeaven 97 x 97 with light step by step, as seen in Planning Example 1. To install the ShowerHeaven, you need a suspended intermediate ceiling. The frame of the ShowerHeaven can be installed in the preconstruction phase.

01

Prior to installation, dismantle the ShowerHeaven, loosen the cylinder head screws and pull out the bearing pins. The ceiling connectors must be 180 mm from the centre of the ShowerHeaven. Hold the frame at the required ceiling location and align accordingly.



02

Drill the borings with a diameter of 8 mm. Every boring has to be fitted with a dowel. Screw in the hanger bolts, attach the frame to the ceiling, and attach them using a washer and nut (SW 13 mm).



03

Connect the equipotential bonding to the frame and the 230V cable to the junction box. Hemen and screw in the T-pieces and angle cleats.



04

Install the functional unit using bearing bolts and cylinder screws.



05

Connect the equipotential bonding and the ground to the frame.



06

Turn the power on and test the lights on the ShowerHeaven. If all lights work, switch the power back off. Secure the functional unit to the long Carabine hook.



07

Screw the pressure hoses to the ceiling connectors.



08

Fold the functional unit upward and secure with the short carabine hook. Examine hose connections for tightness.



09

Install the functional unit using bearing bolts and cylinderscrews. Install the intermediate ceiling.



10

Hook the decorative plate on the three bowden cables using Carabine hooks.



11

Insert the decorative plate into the premounted centering sleeves and secure with countersunk screws.



12

Remove the centering sleeves.



13

Secure the decorative plate using counter-sunk screws.



14

Screw on the protective lenses for the lights. Make sure the form seal is installed properly.



15

Carry out functional test.



Cleaning instructions

The overhead shower is easy to clean

The spray disc of the overhead shower 24 x 24 is easy to remove and can conveniently be cleaned by hand or in the dishwasher. Please note our cleaning recommendations in the installation manual or on the internet.

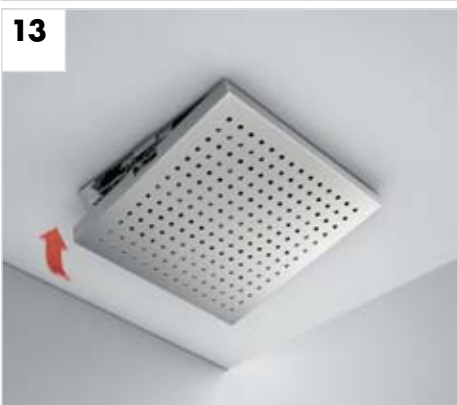
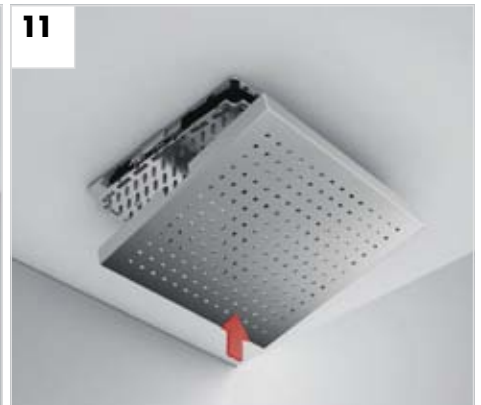
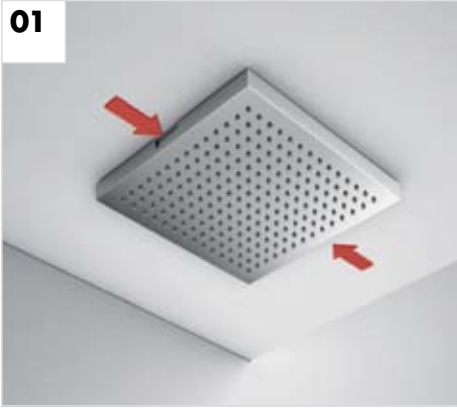

Thermostat modules



1

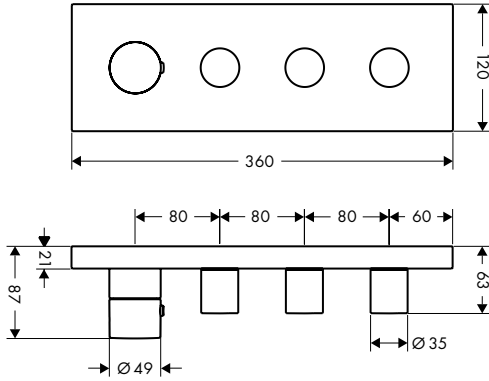

3

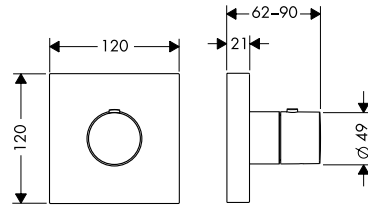

2

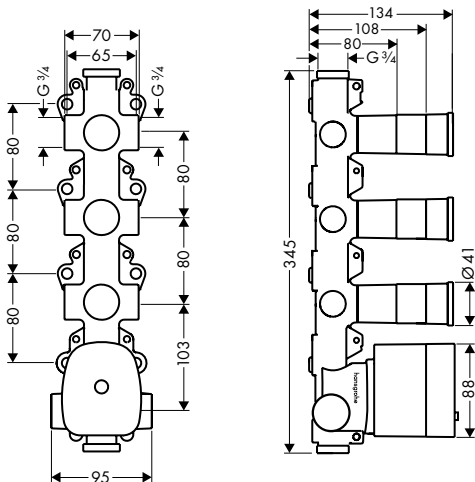

4

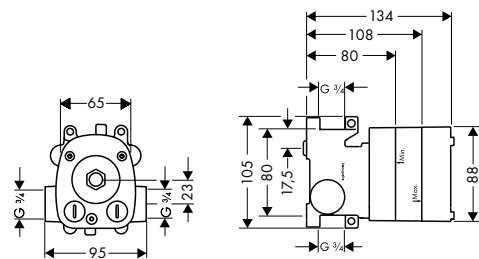

Thermostat modules

1 Thermostat module 36 x 12 finish set
Product no. 10751000

3 Thermostat module 12 x 12 finish set
Product no. 10755000

2 Basic set for thermostat module 36 x 12
Product no. 10750180

4 Basic set for thermostat module 12 x 12
Product no. 10754180

Valves/diverters



1

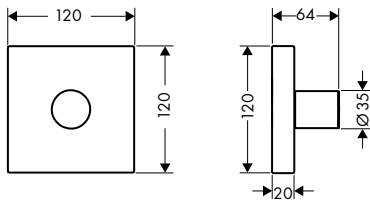

3

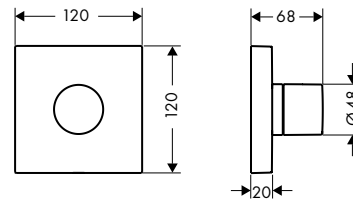

2

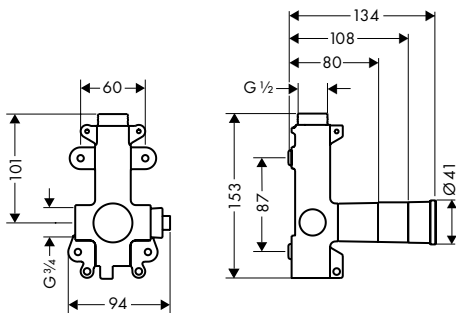

4

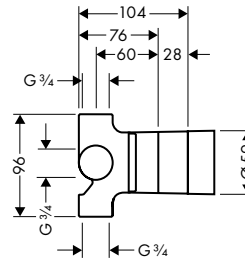

5

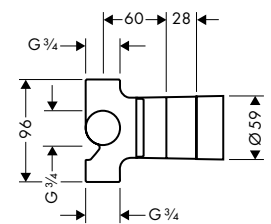

Valves/diverters

1 Shut-off valve 12 x 12 finish set
Product no. 10972000

3 Trio®/Quattro® 12 x 12 finish set
Product no. 10932000

2 Basic set for shut-off valve 12 x 12*
Product no. 10971180

4 Basic set for Trio®
Product no. 15981180

5 Basic set for Quattro®
Product no. 15930180

* In combination with other modules with a clearance of 10 mm, we recommend using the basic set specified. Alternatively, the shut-off valve can also be installed with the basic set in the case of a free/detached installation.
**Product no. 15973180/
Product no. 15974180/
Product no. 15970180**

Hand shower module/waterfall spout

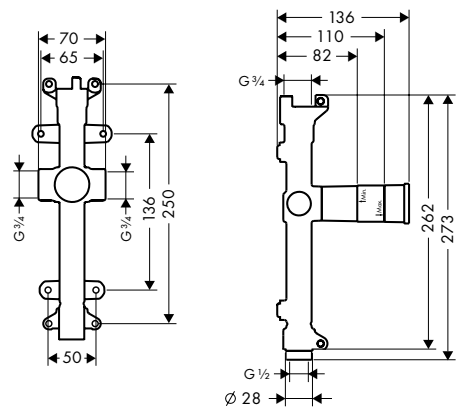
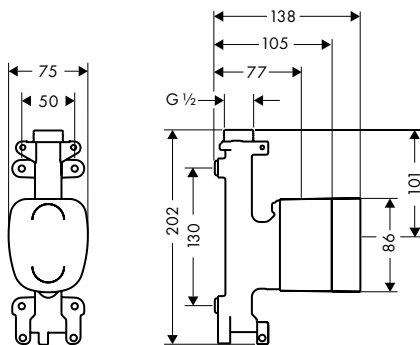
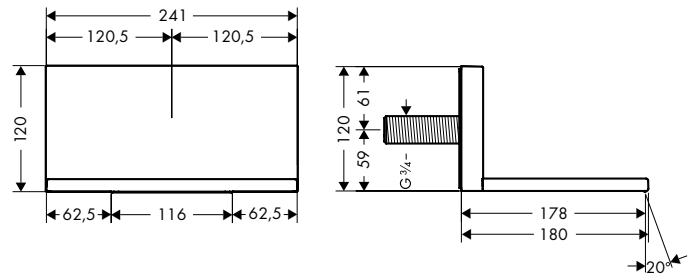
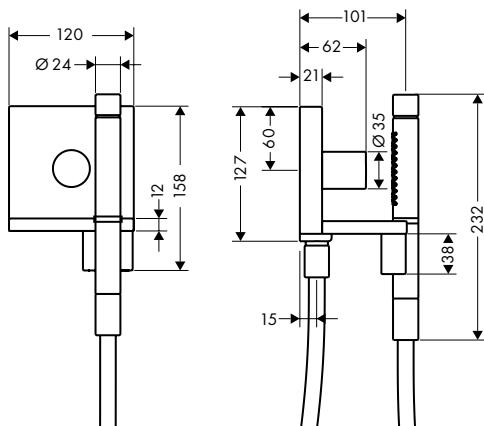

Hand shower module/waterfall spout

6 Hand shower module
12 x 12 finish set
Product no. 10651000

8 Waterfall spout 24 x 12 finish set
Product no. 10942000

7 Basic set for hand shower module
12 x 12
Product no. 10650180

9 Basic set for waterfall spout 24 x 12
Product no. 10941180

Showers



1



2



3

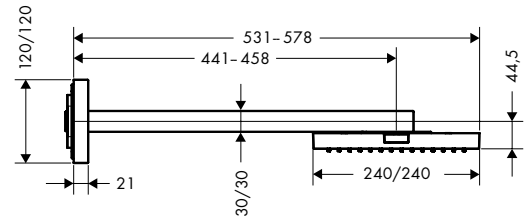
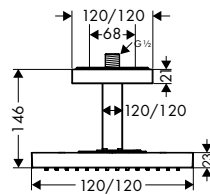
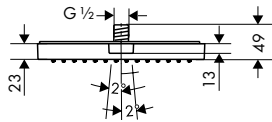

4

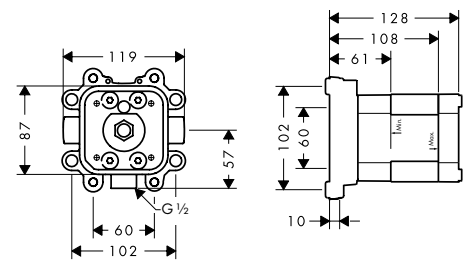

Showers

1 Overhead shower 24 x 24 for installation flush with ceiling
Product no. 10924000

2 Overhead shower 24 x 24 with ceiling connector
Product no. 10929000

3 Overhead shower 24 x 24 with shower arm
Product no. 10925000

4 Basic set for overhead shower 24 x 24 for installation with shower arm
Product no. 10921180

Showers



5

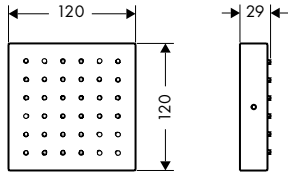

6

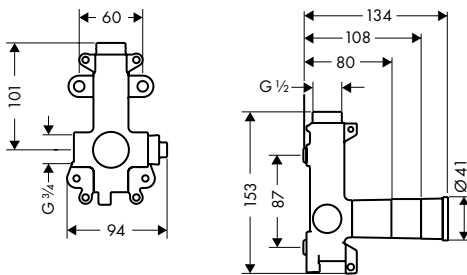

Installation aids



7

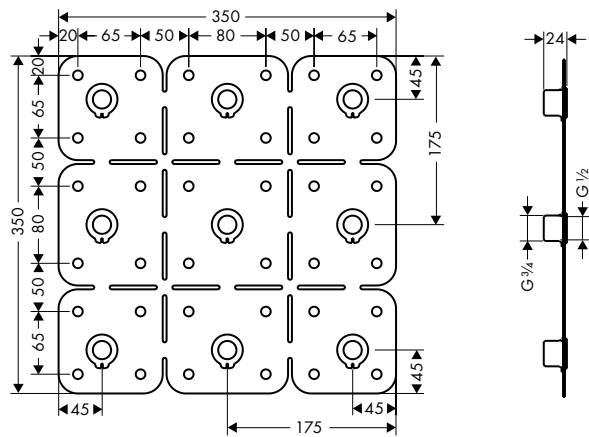

8

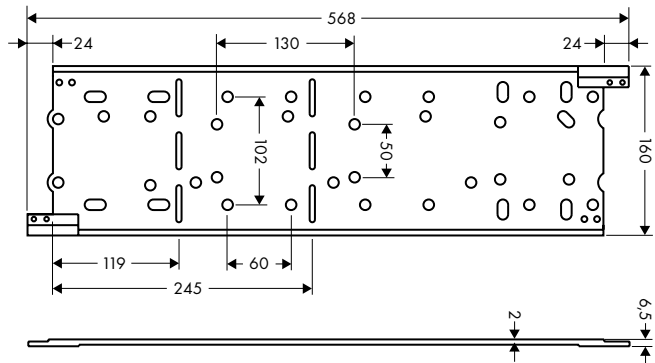

Showers

5 Shower module 12 x 12 finish set
Product no. 28491000

6 Basic set for shower module 12 x 12*
Product no. 28486180

Installation aids

7 Installation plate for shower modules installed as an overhead shower
Product no. 28470180

8 Installation plate
Product no. 10973180

* Alternatively, the shower module can also be attached via a G 1/2 connection in the case of a free/detached installation. In combination with other modules, we recommend using the basic set specified.

ShowerHeaven

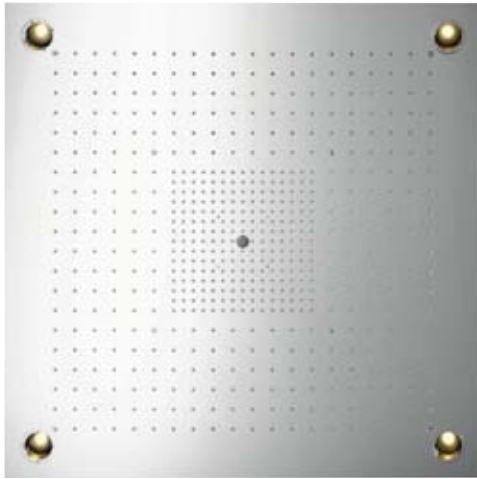

1

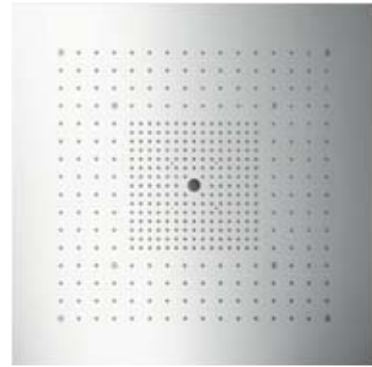

2

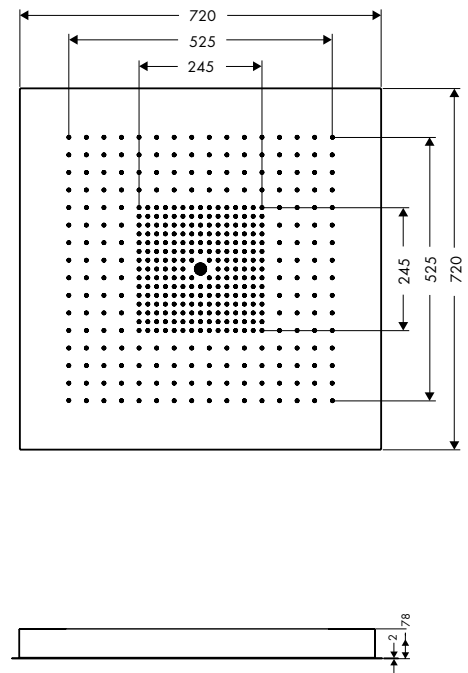
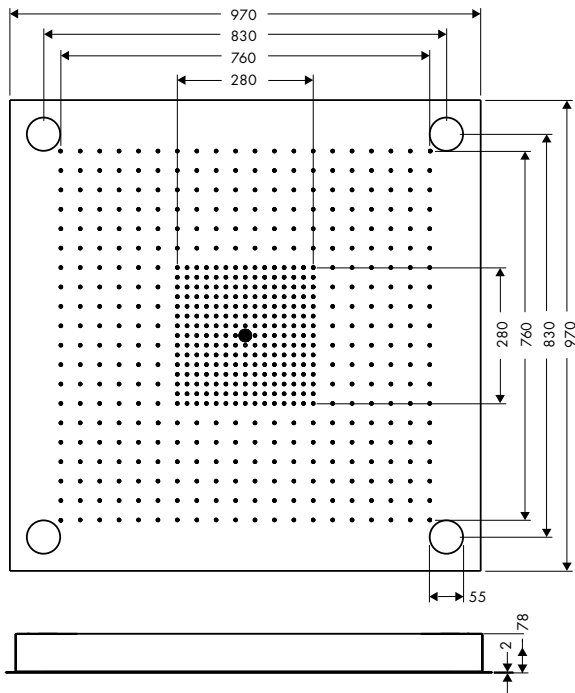

ShowerHeaven

- 1** ShowerHeaven 97 x 97 with light
(inside wall installation)
Product no. 10623800
ShowerHeaven 97 x 97 without light
(not shown)
Product no. 10621800

- 2** ShowerHeaven 72 x 72 without light
(exposed installation)
Product no. 10625800
ShowerHeaven 72 x 72 with light
(not shown)
Product no. 10627800

Accessories



3

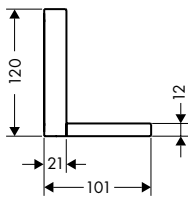
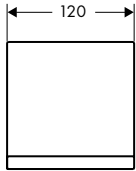

5

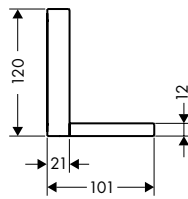
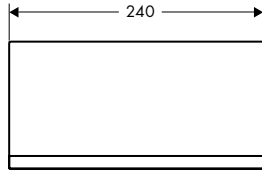

7

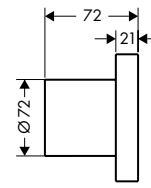
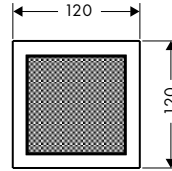

9

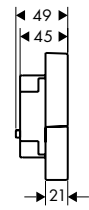
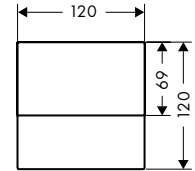

4

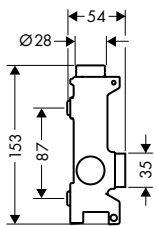

6

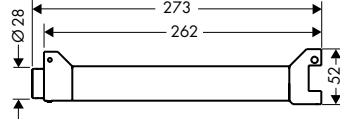

8

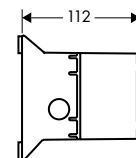
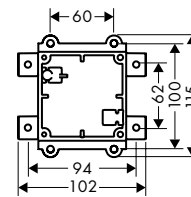

Accessories

3 Shelf 12 x 12
Product no. 40872000

5 Shelf 24 x 12
Product no. 40873000

7 Loudspeaker module 12 x 12 finish set
Product no. 40874000

9 Light module 12 x 12 finish set
Product no. 40871000

4 Basic set for shelf 12 x 12*
Product no. 40877180

6 Basic set for shelf 24 x 12*
Product no. 40878180

8 Basic light/speaker module kit 12 x 12
Product no. 40876180

The references



Sunseeker Predator

The 38 m long luxury yacht of the manufacturer Sunseeker, based in southern England, provides up to 10 on-board passengers first-class facilities. The interiors are tailored to the requirements of its owner. The Axor ShowerCollection with Philippe Starck emphasises this individuality and means that it is possible to design your own personal spa in a compact space.

Shipyard: Sunseeker International Limited, Poole/UK

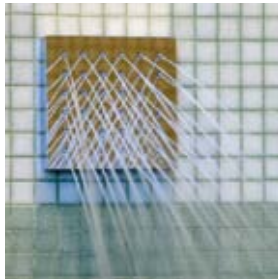

Budersand Hotel Golf & Spa, Sylt

Guests at the exclusive Budersand Hotel Golf & Spa on the southern coast of Sylt are taken aback by the luxurious spa. The centrepiece of the facility is the colourfully illuminated swimmingpool with clear sea view. The 'experience shower' gives the Axor ShowerCollection with Philippe Starck its special flair - crowned by almost one square metre of ShowerHeaven.

The 21 rooms and suites are equipped with the Axor Citterio collection.

Architects: Dierks, Kunze & Oevermann (dko), Berlin/Germany
Interior designer: Jan Wichers, Hamburg/Germany



Argentina – Hansgrohe S.A. · Av. del Libertador 14.323 · Martínez · B1640APB · Buenos Aires · Argentina
Tel. +54 11 4733 2400 · Fax +54 11 4733 2499 · info@hansgrohe.com.ar · www.hansgrohe.com.ar

Australia – Hansgrohe Pty Ltd · Level 1 · 123 Camberwell Rd · East Hawthorn · Victoria 3123 · Australia
Tel: +61 3 9811 9971 · info@hansgrohe.com.au · www.hansgrohe.com.au

Cyprus – Hansgrohe Middle East & Africa Ltd. · Pentadaktilou Street 2 · Office 104 · CY-7101 Larnaca (Aradippou)
Tel. +357 24 813081 · Fax +357 24 813031 · me.support@hansgrohe.com · www.hansgrohe-middleeast.com

Hungary – Hansgrohe Kft. · 1139 Budapest · Forgách u. 11-13. · Telefon +36 1 2369090
Telefax +36 1 2369098 · info@hansgrohe.hu · www.hansgrohe.hu

India – Hansgrohe India (pvt.) Ltd. · Office Nos. 601–604 · Sky Station · Viman Nagar · 411 016 Pune · Maharashtra · India
Tel. +91 20 6625 9595 · info@hansgrohe.in

Japan – Hansgrohe · Japan K.K. Ono Bldg. 6F · 2-15-21 Takanawa · Minato-ku · Tokyo 108-0074 Japan
Tel. +81 3 5424-1950 · Fax +81 3 3449-9651 · info@hansgrohe.co.jp · www.hansgrohe.co.jp

Mexico – Hansgrohe · Col. Lomas de Santa Fe · 01210 México, D.F. · Tel. +52 55 5261-4191
Fax +52 55 5261-4199 · info@hansgrohe.com.mx · www.hansgrohe.com.mx

Portugal – Hansgrohe · Rua Antoine de Saint Exupéry Alapraia · P-2765-043 Estoril
Tel. +351 21 4667110 · Fax +351 21 4667119 · hansgrohe@jrb.pt

South Africa – Hansgrohe South Africa (Pty) Ltd. · P.O. Box 2912 · 136 Walton Road
Carlswald Midrand · ZA-1685 Halfway House · Tel. +27 11 468 11-50 · Fax +27 11 468 11-52
sales@hansgrohe.co.za · www.hansgrohe.co.za

Singapore – Hansgrohe Pte. Ltd. · 69 Mohamed Sultan Road · Singapore 239015
Tel. +65 6884 5060 · Fax +65 6884 5070 · info@hansgrohe.com.sg · www.hansgrohe.com.sg

Sweden – Hansgrohe · Ridspögatan 10 · S-213 77 Malmö · Tel. +46/(0)40-51 91 50
Fax +46/(0)40-13 05 92 · info@hansgrohe.se · www.hansgrohe.se

Turkey – Dizayn Ltd. Şti. · Ortaklar Cad. Bahçeler sok. No: 17 · Mecidiyeköy İstanbul · Tel. +90 212 273 07 30 PBX
Faks: +90 212 275 75 12 · info@hansgrohe-tr.com · www.hansgrohe-tr.com

United Kingdom – Hansgrohe Limited · Units D1 and D2 · Sandown Park Trading Estate · Royal Mills
Esher · Surrey · KT10 8BL · Tel. +44 (0) 1372 465 655 · Fax +44 (0) 1372 470 670
enquiries@hansgrohe.co.uk · www.hansgrohe.co.uk



en-Axor ShowerCollection professional brochure · Subject to technical alterations and colour differences due to the printing process.
Form-Nr. 84 120843 · 08/12/22.015 · Printed in Germany · Printed CO₂-compensated on 100% chlorine-free bleached paper.

AXOR[®]
hansgrohe

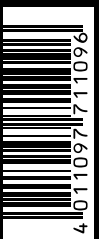

Axor-Hansgrohe SE · P.O. Box 1145 · D-77757 Schiltach · Telephone +49 7836 51-0
Fax +49 7836 51-1300 · info@axor-design.com · www.axor-design.com