

AXOR



NEWS PRODUCT CATALOGUE 2024

Errors and omissions excepted. Upon publication of this price list, all previously published price lists are no longer valid. Figures given for dimensional drawings are in mm. When installing the products, please follow the instructions in the installation manual. All products are subject to availability. The availability may be temporarily impacted by material shortages, interruptions in the supply chain or other force majeure events. Please contact us for further details.

Contents

AXOR Brand	4
AXOR Citterio C	41
AXOR ShowerSelect ID	67
AXOR iBox	83



Modern bathroom planning is increasingly about expressing personal style. For more than 30 years, AXOR has stood for the design of personal bathrooms.

To this end, customers have access to an impressive range of around 2,000 products from the AXOR collections and AXOR programs. The collection and program overviews in the AXOR Product Catalog list all products – from classic to avantgarde – including the key sales arguments to get your customers on board with AXOR. With the AXOR FinishPlus and AXOR Signature customization services, AXOR offers even more options for designing individual bathrooms. Find out how AXOR uses new materials to turn the faucet into a sensuous experience in terms of feel and look in the chapter on customization. Support for shower planning with selected product combinations, as well as concrete installation tips, can be found in the Planning and Installation chapter. In the AXOR Inspiration chapter, you will find projects from all over the world that show how AXOR products contribute to the unique style of a hotel or residence. Our Design Lexicon serves as a reference for your sales meetings with design-savvy customers. Here, you will find explanations of the most important terms from the world of architecture and design.

For us, rooms are more than a home. They are sources of inspiration that turn everyday actions into conscious rituals. The objects used in the process reflect not just the taste, but also the personality of their inhabitants.

From personalities –

Our iconic objects for luxury bathrooms and kitchens are created in collaboration with some of the best designers of our time, whose ideas challenge our habits of perception and change our everyday lives. People who live individuality and understand design as an expression of personality.

for personalities

The bathroom and kitchen are among some of our most intimate living spaces, places where we often just take care of ourselves. The element of water we use to do so is a precious commodity. Through outstanding design, we give it a form that unmistakably expresses this appreciation.

FROM PERSONALITIES FOR PERSONALITIES

The AXOR Success Story

For more than 30 years, AXOR has been helping architects, interior designers, and discerning customers express their personalities. AXOR has permanently changed the design and understanding of faucets and bathrooms like no other brand has – from functional sanitary spaces to individual places of wellbeing.

In 1981, Klaus Grohe commissions the first designer faucet for the Hansgrohe Group: Allegroh, designed by Esslinger Design, origin of the famous Frog Design studio. The first faucet collection in color, UNO, becomes an innovative market sensation. In the 1990s, design becomes a hallmark of prestige, and Klaus Grohe discovers its potential for the sanitation industry. This marks the beginning of AXOR's success story as a design brand for luxurious products to make the bathroom and kitchen more personal – inspired and created by world-famous, renowned designers.



- 2006 AXOR Massaud and AXOR Montreux
- 2007 AXOR Citterio M
- 2008 AXOR ShowerCollection – the first shower product range
- 2009 AXOR Urquiola
- 2012 AXOR Starck Organic
- 2013 AXOR WaterDream and product launch of AXOR Showers designed by Front and Nendo

1993

Establishment of the AXOR Brand



AXOR Citterio

2003



2014



- 2014 AXOR Starck V, AXOR Citterio E and AXOR Universal Accessories
- 2015 AXOR One shower products designed by Barber Osgerby and AXOR WaterDream with the ÉCAL design school
- 2016 AXOR WaterDream "Create your own spout"

- 1994 AXOR Starck: Presentation with Salon d'eau by Philippe Starck
- 2000 AXOR WaterDream with PHOENIX – an innovative concept bathroom
- 2003 AXOR Citterio
- 2004 AXOR Starck – Redesign
- 2005 AXOR WaterDream with Patricia Urquiola, Jean-Marie Massaud and Ronan & Erwan Bouroullec

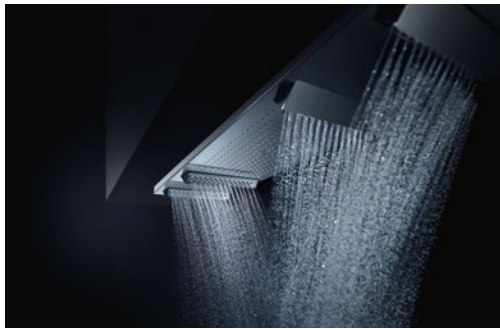

2017

AXOR Showers
PowderRain

- 2017 AXOR Uno redesign and AXOR Showers with the innovative PowderRain spray mode
- 2018 AXOR MyEdition

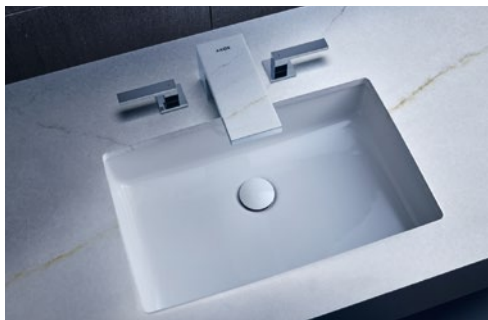

2019 AXOR Edge

2021

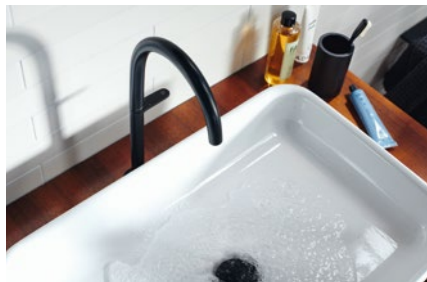

2021 AXOR One
AXOR Citterio lever handle variants
AXOR Universal Circular Accessories

- 2022 AXOR Conscious Showers
- AXOR Universal Rectangular Accessories
- AXOR Starck Nature Shower Column



2023

- 2023 AXOR ShowerComposition
- AXOR Suite Basin & Bathtub
- AXOR Drain
- AXOR One Matt White

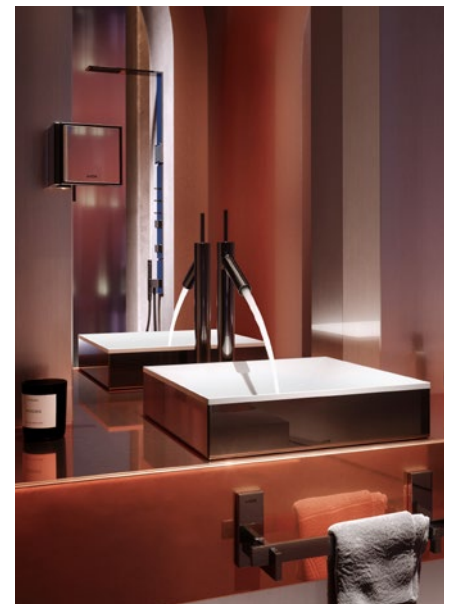

Philippe Starck

DESIGN VISIONARY

Philippe Starck is one of the most well-known creators of our time. Subversive and poetic, unexpected and free-spirited, rebellious and political, Starck experiments with a mission and a vision: creation, whatever shape it takes, must make life better for the largest number of people possible. As a vision of a better world, his creations attest a responsibility for society and the environment and a love for humanity.



Barber Osgerby

AGENTS OF INTERACTION DESIGN

Barber Osgerby embody the philosophy of interaction design. They stand for the interaction of the user with the product - what they see, hear and need. An art of design that's led to international public commissions and international awards, including the title of Royal Designer for Industry and the Order of the British Empire.

Jean-Marie Massaud

DESIGN ART THAT CONNECTS PEOPLE
AND SPACES

Massaud's unmistakable style provides refreshing stimulation – from product design to architecture. His creations are meant to touch people and provide a better place to live. Strongly influenced by the beauty and utility of nature, he creates synergies between people, design, and space.



Antonio Citterio

MASTER OF ELEGANCE

Nobody else has had an impact on Italian design like Antonio Citterio. As an architect, designer and perfectionist, he creates luxurious objects, interiors and architectural concepts for leading international brands. His signature shows an uncompromising combination of timeless forms and high-quality materials, always under the credo of perfection, of Italian elegance.



Patricia Urquiola

VIRTUOSA OF STYLE FUSION

The Spanish designer enriches the international architecture and design scenes with her feminine design objects. She skillfully combines styles, patterns and materials. She surprises with floral decor, a sensual feel and arouses curiosity with her creations.

PHOENIX

DESIGN FOR REAL LIFE

PHOENIX's creations are tailored to people's real needs and desires in their everyday lives. Touching and forward-looking, always driven by logic, morality, and magic.



Nendo

POETIC DESIGN FROM JAPAN

Oki Sato's creations break with convention. And are easy to understand. The name of his office translates as "modeling clay." An indication that his designs are created in a very playful way. This approach has put him at the top of the international design scene.



Front

THE SWEDISH "AVANTGARDISTES"

Their design isn't typically Scandinavian. It is experimental, a play with visual effects inspired by fashion, film, and science. Their trademark is their ironic point of view and the joy of surprise. Qualities that have the international design scene buzzing.



Why

FIVE REASONS TO CHOOSE AXOR

01 Design diversity

AXOR collaborates with internationally renowned designers. With their highly distinct signatures, they shape the great stylistic diversity and product depth of the AXOR range. Their design approaches set standards again and again – in terms of their avantgarde designs, which are innovative and timeless at the same time. As part of AXOR WaterDreams, designers from completely different disciplines create their vision of the bathroom of the future, completely detached from a product-oriented development. With their ideas, they provide new inspiration for the development of the space, its use, and matching products.

In the following collections, unique water designs create extraordinary haptic and visual experiences – with innovative spray modes and a completely new way of presenting water:

- AXOR Massaud with a natural looking waterfall
- AXOR Starck Organic with the gentle shower spray on a faucet for the first time
- AXOR Starck V with powerful water vortex
- AXOR MyEdition with PowderRain – fitting the faucet design

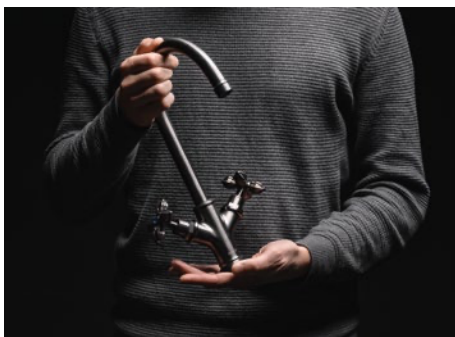

02 Individualization

The exclusive AXOR FinishPlus and AXOR Signature customization services meet customers' increasing demand for more options to customize bathroom products. With colored PVD surfaces and customized solutions, AXOR products become unmistakably unique.

03 Made in Germany

At AXOR's own factory at its headquarters in Schiltach, Germany, the first-class brand products are created with German engineering quality and a deep commitment to precision – in every detail. This know-how builds on the Hansgrohe Group's more than 120 years of experience, as well as the expertise of every single skilled worker. AXOR is also a pioneer in innovative manufacturing technologies, such as the latest generation diamond drilling machine for ultra-precision milling of surfaces in the AXOR Edge collection.



04 Worldwide presence

As part of the Hansgrohe Group, AXOR has 33 subsidiaries and 21 sales offices worldwide and supplies its products to over 146 countries. AXOR faucets, showers, and kitchen faucets can be found in the world's finest homes, hotels, and restaurants. International architects, planners, and builders trust AXOR quality in products and expert advice.

05 International design awards

AXOR's design achievements – marked by independent, internationally renowned industry experts – are confirmed by the numerous awards the brand has received for first-class product design since the very beginning. These include:

- Red Dot Best of Best for AXOR Edge
- iF Design Award in Gold for AXOR ShowerComposition, AXOR One and AXOR Uno
- Green Design Award for AXOR Starck Organic



reddot design award

AXOR is dedicated to creating the highest quality products. Sustainably.

AXOR contributes to a more sustainable future by designing luxurious products for water-related spaces that will last a lifetime. The brand adheres to eco-design principles and seeks to promote sensible consumption.

As part of the Hansgrohe Group, AXOR is committed to Science-Based Targets. Developed exclusively in Europe, our products are designed to be timeless and built to last. Ninety percent of our portfolio is produced at the AXOR Centre for Excellence in Germany's Black Forest.

In 2022, the Hansgrohe Group switched all international production sites to green electricity. This enables annual savings of over 26,000 tons of CO₂. "The Hansgrohe Group defines "ECO" as the reduction of water and/or energy consumption of water-bearing products in use by at least 22 percent compared to the base year 2020."

As part of the Hansgrohe Group, AXOR is committed to supporting five UN Sustainable Development Goals.

Enduring design meant to last a lifetime

AXOR products are designed to be updatable throughout their service life. Any required maintenance or repairs can be easily performed without special tools. AXOR takes pride in its products' quality, which is why AXOR's manufacturer's warranty extends well beyond any legally required timespan. To ensure a secure investment, AXOR guarantees the availability of spare parts for our products for fifteen years—five years more than the legal requirement.

More information:

axor-design.com/int/service/product-guarantee



For almost 30 years, AXOR's ongoing collaboration with Phillippe Starck has set the benchmark for sustainability through timeless, essentialist designs meant to last a lifetime.

Saving water is essential to AXOR

Water is one of our most precious resources. That's why, while continuing to offer water-saving products such as AXOR Conscious Showers, the AXOR product portfolio will be restructured over the coming years, placing even greater emphasis on water-efficiency. Why? Because reducing a product's water consumption also reduces the energy needed to heat that water, thus reducing carbon emissions.



AXOR plans to convert all water-consuming products to its "ECO" specifications by 2030, meaning the products will be available exclusively with water-saving technologies, all while offering the same exceptional functionality and performance.

More information: pro.hansgrohe.com/your-selling-points/innovative-technologies/ecosmart

Our water-saving Conscious Shower produces a generous water spray.

Collaboration lies at the heart of AXOR's Mission

AXOR strives to produce in a resource-friendly manner. Beyond developing all AXOR products exclusively in Europe—and manufacturing 90% of them at its AXOR Centre for Excellence in Germany's Black Forest—the brand maintains long-standing relationships with regional suppliers that prioritize sustainability. Furthermore, the company has developed specific eco-design guidelines for the future development of the entire product range.



Fair working conditions are central to AXOR's sustainability mission.

Making more from less: AXOR's Eco-Design Guidelines

Material management is an essential component of AXOR's sustainability strategy. Throughout the design, production and extended life of a product, AXOR implements a range of measures to promote a minimal environmental impact.

Closing the Cycle

Our products are completely separable by type, allowing exclusively recyclable components to be returned to the material cycle, either via customer recycling or product take-back with subsequent remanufacturing/recycling by Hansgrohe.

Less Complexity

Through innovative design, AXOR ensures its products consist of components and parts that can be used universally across the portfolio, which reduces complexity and costs.

Less Material

AXOR aims to produce material-efficient products by using as little raw material as possible. Furthermore, AXOR strives to find sustainable, environmentally sound alternatives for widely used materials, which is why our products do not use inseparable composites or material mixes.

Less Coating

AXOR products are durable even without coating. However, when coatings are necessary, they are applied using environmentally friendly surface technologies and the lowest possible amount of materials. To ensure the recyclability of components, coating thickness is kept as low as possible.

Staying Clean

The design of AXOR products and the choice of materials are intended to prevent dirt and lime deposits and to make effective cleaning possible without the use of aggressive, environmentally harmful cleaners.

Climate neutrality* since 2022



After successfully converting its plant in Schiltach, Germany, to green electricity, Hansgrohe did the same with all of its international production sites at the beginning of 2022. This reduces CO2 emissions by more than 26,000 tons annually. Subsequent energy efficiency analyses at Hansgrohe's production plants in France, China and Germany have identified further potential sustainability measures such as:

- combined heat and power plants and photovoltaics,
- peak load and solar irradiation planning

In its facility in Shanghai, AXOR has already begun to utilize heat pump technology on the heating system for the electroplating baths.

All international production plants have also set their own aspirational sustainability targets for water, waste and energy. As a result of these efforts, all Hansgrohe Group plants worldwide have been climate neutral* since 2022.

*Climate neutrality refers to greenhouse gas emissions from Scope 1 and 2 (direct emissions and energy consumed at the sites) according to the Greenhouse Gas Protocol. The Hansgrohe Group tries to reduce emissions wherever possible. The remaining emissions are offset through recognized, certified climate protection projects. For more information, please visit <https://www.hansgrohe-group.com/en/about-us/sustainability>.

UN Sustainability goals

Water is life, and water is our passion. We create inspiring moments while protecting this precious element. In doing so, we take responsibility for people and the environment. The Hansgrohe Group is committed to supporting five UN Sustainable Development Goals:

1. Good Health and Well-being
2. Clean water and sanitation
3. Decent work and economic growth
4. Responsible consumption and production
5. Climate action



Maximum services



AXOR FINISHPLUS AND AXOR SIGNATURE

With these customization services, AXOR answers customers' personal wishes and the demand for distinctive design. More at: [axor-design.com](https://www.axor-design.com)



FIVE-YEAR MANUFACTURER'S GUARANTEE

The manufacturer's warranty extends beyond the legally required period and underlines AXOR's quality claim. In addition, strict quality management is already applied during the manufacturing process to ensure products meet the high requirements of independent testing institutes and legal regulations. Please note the warranty conditions at: [axor-design.com/en/service/product-warranty](https://www.axor-design.com/en/service/product-warranty)



15 YEARS GUARANTEED AVAILABILITY

Fifteen years guaranteed availability for spare parts for AXOR products ensures a secure investment. All information and products is fast and easy to find online in the Spare Parts Shop: [spareparts.hansgrohe.com](https://www.spareparts.hansgrohe.com)



PROFESSIONAL WEBSITE

On the portal, specialist retailers, architects, and installers can find information, planning data, and prices for all products, as well as practical tips and tools for professional bathroom planning and advice. More at: [pro.hansgrohe-asia.com](https://www.pro.hansgrohe-asia.com)

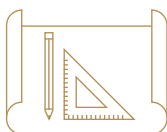

PLANNING DATA

Installation and service instructions, dimensional drawings, BIM planning data and 3D data for optimal bathroom planning with AXOR products can also be found in the professional portal: [pro.hansgrohe-asia.com](https://www.pro.hansgrohe-asia.com)



COMFORTZONE TEST

Create the perfect combinations of faucets and sinks in this internal test center. For this purpose, matching sinks from leading manufacturers are tested with AXOR products for optimal functionality and appearance. All recommended combinations can be found on the AXOR website on the respective collection page: [axor-design.com](https://www.axor-design.com)



MEISTERSERVICE

AXOR service specialists are trained sanitation experts with advice on technical issues – by phone, email, or chat. In special cases, a specialist for building services can also be available on site. If required, local contacts are available by phone or e-mail: service@axor-design.com



PROJECT CONSULTATION

AXOR offers professional support and advice for project tenders and planning worldwide. If required, please contact your local contact partner or send an email to: service@axor-design.com

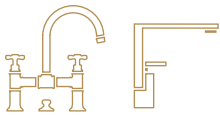

BATHROOM EXHIBITION

Experience AXOR live worldwide: The WaterStudios in architectural and design metropolises are sources of inspiration and meeting places, design and training centers for trade partners, architects, and interior designers. In the Aquademie at the brand's headquarters in Schiltach, Germany, visitors and trade partners can experience a bathroom and kitchen world over 1,000 square meters with a museum on the history of the bathroom, the company, and the brand, regular events, and a Showerworld for test showers.



ONLINE AQUADEMIE

You can access the newly developed Hansgrohe Online Aquademie via the trade partner website. Here, partners in the trade and crafts can benefit from detailed knowledge on the topics of products and sanitation technology, as well as from non-technical highlights. More information at: [aquademie-seminars.hansgrohe.com](https://www.aquademie-seminars.hansgrohe.com)

Design icons and style diversity

From classic to modern: AXOR faucets, showers, washbasins, bathtubs and accessories. Unique, avant-garde pieces and complete collections. Created with world-renowned designers. Uncompromising in quality. Full of pioneering innovations. In pursuit of perfection.



AXOR One



AXOR Edge



AXOR MyEdition



AXOR Starck



AXOR Starck Organic



AXOR Citterio



AXOR Citterio E



AXOR Citterio M



AXOR Urquiola



AXOR Massaud



AXOR Uno



AXOR Montreux



AXOR Showers



AXOR Accessories



AXOR Electronic faucets



AXOR Wash basins and bathtubs



AXOR Kitchen faucets



AXOR Drain, wastes and overflows



AXOR Basic sets

Uncompromisingly innovative

Pioneering ideas. Shaping water into invigorating jets, enveloping cocoons and sensual flows. Intuitive systems. Simple to use, easy to clean and ecologically responsible. Promoting conscious and conscientious water use. The result of intensive research and development, AXOR technologies are made in Germany to the highest quality standards – our own. In pursuit of perfection.



AIRPOWER-TECHNOLOGY:

Enriching water with air produces plump droplets for a velvety touch on the skin.



POWDERRAIN-TECHNOLOGY:

The finest silicone nozzles, with several openings per nozzle, provide a uniquely fine mist of water.



QUICKCLEAN-TECHNOLOGY:

Remove limescale deposits quickly and easily with flexible silicone nozzles.



SELECT-TECHNOLOGY:

Use the Select button to switch spray modes or shower heads; turn the water on and off at the faucet.



ECO-SMART-TECHNOLOGY:

Faucets and showers that consume up to 60% less water than our conventional products.
More information: pro.hansgrohe.com/your-selling-points/innovative-technologies/ecosmart

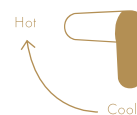

COOLSTART-TECHNOLOGY:

Cold water flows automatically when in the neutral handle position.



COMFORTZONE:

Defines the space between the wash basin and faucet. The larger the ComfortZone, the greater the variety of uses.



Individual expression in the bathroom

With collections in a variety of styles, AXOR responds to the desire for individualization in the bathroom. AXOR FinishPlus and AXOR Signature are two services for maximizing options for customers to express their personalities.

With the brushed or polished versions of colored AXOR FinishPlus surfaces, mixers, showers and accessories become design objects that perfectly complete an interior design and create an exclusive accent. The durable, high-quality surfaces are manufactured in a physical vapor deposition process (PVD).

The AXOR Signature service responds to customer requests for modifications such as inscriptions of the customer's signature, or inscriptions in the local language. The service can also provide extended shower connections to meet certain spatial requirements or to modify the mixer spout with respect to the unusual geometry of a wash basin. Experts with many years of experience and a love of detail address the modification requests, creating solutions in accordance with the most advanced industrial standards.

THE TWO SERVICES
HAVE ONE THING IN
COMMON: THEY RESULT
IN PRODUCTS THAT
COMBINE INDIVIDUALITY
AND QUALITY AT THE
HIGHEST LEVEL.

SPECIAL FEATURES OF THE INDIVIDUALIZATION SERVICES:

- / Exclusively developed surfaces for AXOR FinishPlus, bring unique personality to the bathroom or kitchen
- / through the use of color
- / The extremely durable surfaces are created with the physical vapor deposition (PVD) process in the AXOR production facility in Schiltach, Germany
- / The lacquered Matt Black and Matt White finishes offer customers maximum customization
- / AXOR Signature service implements highly individualized customer requests: Lengthening, shortening, inscription
- / All modifications are carried out by AXOR experts at the highest level of craftsmanship and in accordance with industrial standards

Learn more about AXOR FinishPlus and AXOR Signature:
axor-design.com

AXOR FinishPlus – Refinement of a special kind

Luxury is all about fulfilling personal dreams. AXOR FinishPlus surfaces are expressions of individuality at the highest level. They set new benchmarks for luster, robustness and durability. Whether as single items or in large quantities, they are manufactured at the highest technical level and stand for quality made in Germany.

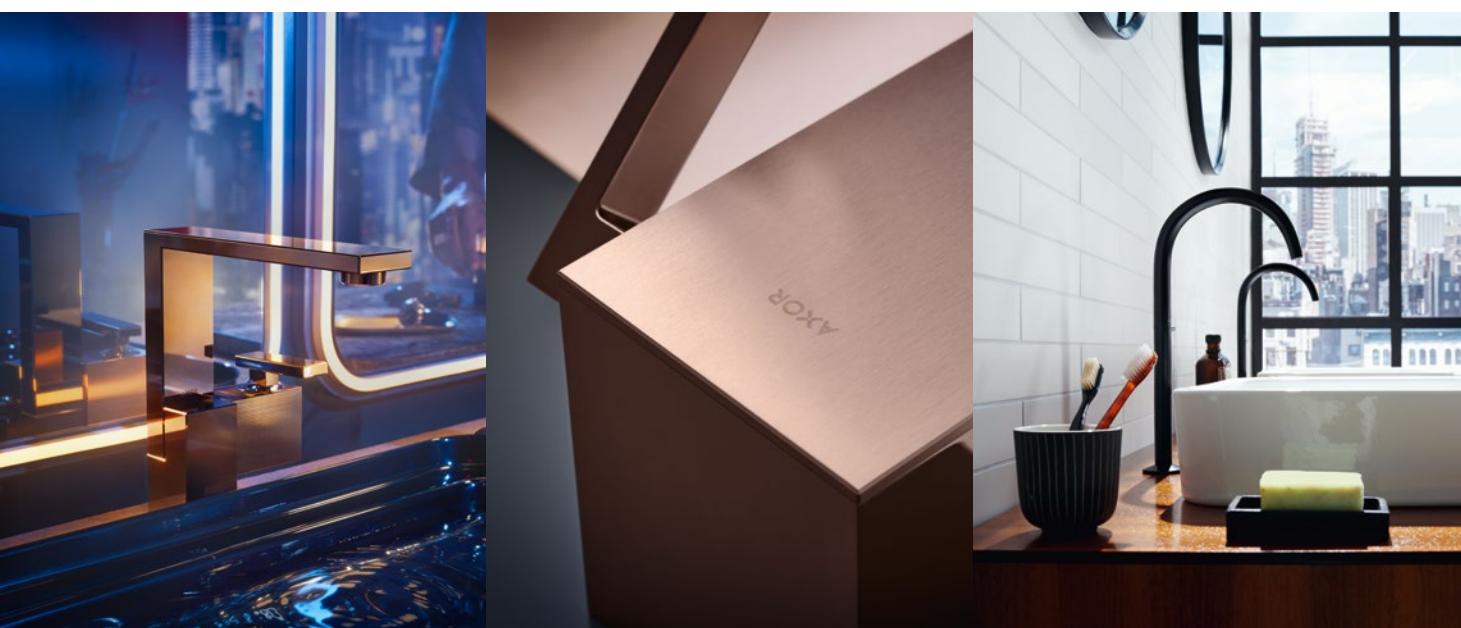

- / AXOR FinishPlus meets the increasing desire for individualization: The surfaces can be made to match the interior design perfectly. A standardized process guarantees consistent quality
- / The Black Chrome and Red Gold surface finishes, developed by our own experts through intensive research work, underline the role of AXOR as an innovative leader in the area of surfaces
- / A mixer with an AXOR FinishPlus surface, along with its spare parts, is available for purchase in an identical quality and design for 15 years
- / In addition to the prespecified AXOR FinishPlus surfaces, other surfaces can be produced according to personal specifications by request through AXOR Signature

Learn more about AXOR FinishPlus:
axor-design.com

AXOR Finishes



Chrome
-000

AXOR FinishPlus PVD-surfaces



Brushed Brass
-950



Polished Gold Optic
-990



Brushed Gold Optic
-250



Brushed Bronze
-140



Polished Red Gold
-300



Brushed Red Gold
-310

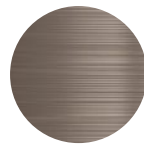

Brushed Nickel
-820

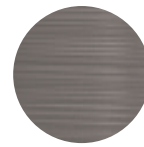

Stainless Steel Optic
-800



Polished Black Chrome
-330

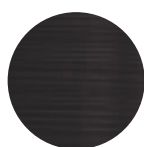

Brushed Black Chrome
-340

AXOR FinishPlus lacquered surfaces

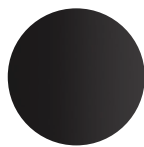

Matt Black
-670



Matt White
-700

The lacquered Matt Black and Matt White finishes are only available for a selected range of AXOR products.



The masterly combination of high-tech and craftsmanship

Electroplating



Chrome is the standard surface in the sanitary environment and has proven itself in the bathroom over many decades. Through the electrochemical deposition of various metals, and depending on the type of substrate, a copper layer is built up in the electroplating bath, followed by a bright nickel and chrome layer on the basic brass body.

PVD

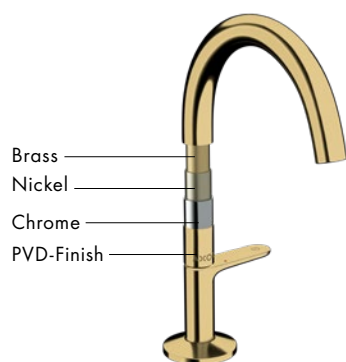

The unmistakable character of the polished and brushed AXOR FinishPlus PVD-surfaces is the result of intensive development, refined in AXOR's in-house vacuum chambers using the physical vapor deposition (PVD) process. The PVD process gives the surfaces an additional metal layer. The vapor deposition of different process gas mixtures creates different light reflections on the surface. The result: exceptional color brilliance and high resistance. In order to reproduce a brushed surface, an additional work step is required in which the surface is textured with a brushing fleece by hand.

Lacquer



The wet-lacquered AXOR FinishPlus surfaces, Matt Black and Matt White, offer a bold color that gives the product a silky, smooth feel and simple elegance.

- / The beneficial properties of PVD surfaces include resistance to scratching, cleaning agents and salty sea air
- / The special textures of the brushed versions are created by hand

Learn more about AXOR FinishPlus:
axor-design.com

AXOR Signature – from the special to the one-of-a-kind

Lengthening, shortening, inscription. AXOR Signature is an exclusive service that takes a design object and makes it one-of-a-kind, whether by providing each mixer with the customer's personal touch or by modifying it to fit specific dimensions. The personal and customized result manufactured by AXOR experts in Schiltach. With the utmost in care and precise craftsmanship in accordance with industrial standards.

AXOR SIGNATURE PROVIDES THE FOLLOWING SERVICES:

- / Extensions, e.g., from wall to wash basin or bathtub, or from the ceiling into the room
- / New developments
- / Component mix
- / Laser engraving, printing, and deep engraving to integrate initials, logos, or additional markings in the national language or another size, as well as special marking for functions
- / Feasibility testing in advance of order acceptance with individualized delivery schedule and price

Learn more about AXOR Signature:

axor-design.com

Standardversion



EXAMPLE INSCRIPTIONS FOR OVERHEAD AND HAND SHOWERS

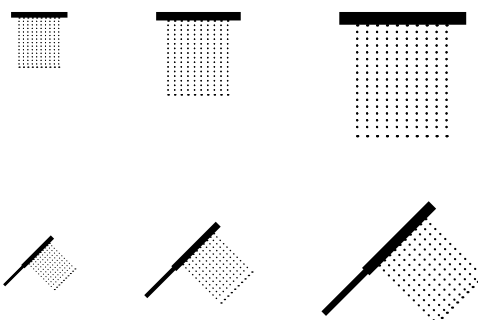



AXOR SIGNATURE FOR AN
INDIVIDUALIZED, PERFECT WHOLE.

CUSTOMIZED VERSION
Application of personalized inscriptions such as
a monogram or icons to clearly identify users



EXAMPLE FOR TEMPERATURE LABELS

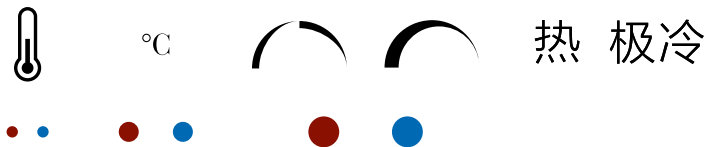

EXAMPLES FOR BRANDING





Lengthening of a ceiling connection - adapted for the height of the room

New development of a faucet handle from the AXOR Montreux collection for the Hotel Villa Copenhagen. In the suites designed by the jewelry company Shamballa Jewels, some of the AXOR faucets are specially equipped with Shamballa gemstone handles.



Length adjustments



Extending a faucet spout, adapted to the height of the sink

Redevelopment



Development of a product according to customer requirements.

Component mix

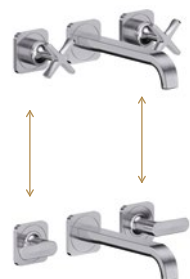

Combination of different design and product components.

A new dimension of individualization

With materials such as metal, glass, wood, marble and leather, AXOR Signature creates an entirely new feel for mixers. The cover plates are carefully selected by AXOR experts and designed to meet high benchmarks for mixer use. Each plate is a one-of-a-kind original.

- / Natural materials impart an especially sensual look and feel
- / Each product is unique, like the natural material itself

Exclusively for the AXOR MyEdition collection.



METAL –
BRUSHED BRONZE



BLACK WALNUT



MARBLE NERO
MARQUINA



NAPPA LEATHER

Inspiration and Information

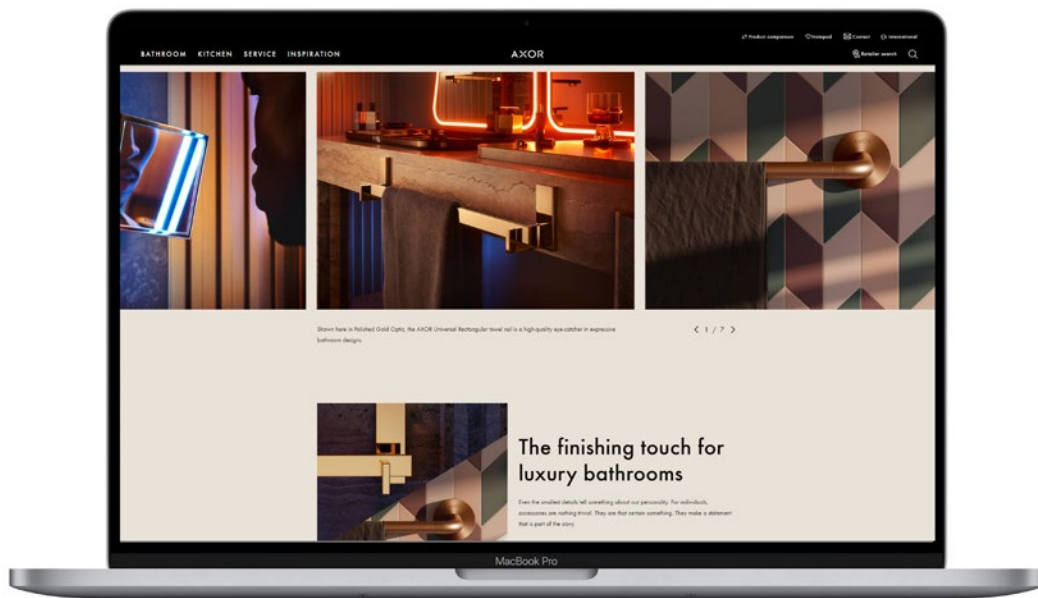

For AXOR, luxury means creating an experience of form and function. One that appeals to the senses and touches people. An experience that begins on the AXOR website. For impressions of and information about all products. For bathroom inspiration and planning. For individualization and refinement possibilities. For background about the brand, the design and the technology.



axor-design.com





Code Numbers and Trade Prices (HG = hansgrohe, AX = AXOR)

brand	Code no.	EAN	page
01			
AX	01400180	4059625316931	86
13			
HG	13588000	4059625477359	86
HG	13632000	4059625464250	87
HG	13637000	4059625534090	87
HG	13638000	4059625536209	87
AX	13640000	4059625560648	81
AX	13640140	4059625560631	81
AX	13640340	4059625560624	81
AX	13640670	4059625560617	81
AX	13640990	4059625560600	81
AX	13641000	4059625560594	81
AX	13641140	4059625560587	81
AX	13641340	4059625560570	81
AX	13641670	4059625560563	81
AX	13641990	4059625560556	81
AX	13642000	4059625560549	81
AX	13642140	4059625560532	81
AX	13642340	4059625560525	81
AX	13642670	4059625560518	81
AX	13642700	4059625560501	81
AX	13642990	4059625560495	81
AX	13643000	4059625560488	82
AX	13643140	4059625560471	82
AX	13643340	4059625560464	82
AX	13643670	4059625560457	82
AX	13643990	4059625560440	82
AX	13645000	4059625560433	82
AX	13645140	4059625560426	82
AX	13645340	4059625560419	82
AX	13645670	4059625560402	82
AX	13645990	4059625560297	82
AX	13646000	4059625560280	82
AX	13646140	4059625560273	82
AX	13646340	4059625560266	82
AX	13646670	4059625560259	82
AX	13646700	4059625560242	82
AX	13646990	4059625560235	82
26			
AX	26039180	4059625509555	64
28			
AX	28017000	4059625503485	58
AX	28017140	4059625555637	58
AX	28017340	4059625555644	58
AX	28017670	4059625555668	58
AX	28017820	4059625555651	58
AX	28017990	4059625555675	58
AX	28790000	4059625525067	61
AX	28790140	4059625543740	61
AX	28790340	4059625543757	61
AX	28790670	4059625543764	61
AX	28790820	4059625543771	61
AX	28790990	4059625543788	61
AX	28791000	4059625525043	61
AX	28791140	4059625543801	61
AX	28791340	4059625543795	61
AX	28791670	4059625543832	61
AX	28791820	4059625543849	61
AX	28791990	4059625543856	61
AX	28792000	4059625525074	62

brand	Code no.	EAN	page
AX	28792140	4059625543900	62
AX	28792340	4059625543894	62
AX	28792670	4059625543863	62
AX	28792820	4059625543887	62
AX	28792990	4059625543870	62
AX	28793000	4059625525081	62
AX	28793140	4059625543955	62
AX	28793340	4059625543948	62
AX	28793670	4059625543917	62
AX	28793820	4059625543931	62
AX	28793990	4059625543924	62
AX	28794000	4059625509579	63
AX	28794140	4059625544020	63
AX	28794340	4059625544013	63
AX	28794670	4059625542088	63
AX	28794820	4059625544006	63
AX	28794990	4059625542095	63
AX	28795000	4059625525302	63
AX	28795140	4059625544068	63
AX	28795340	4059625544051	63
AX	28795670	4059625544037	63
AX	28795820	4059625544044	63
AX	28795990	4059625544075	63
AX	28801000	4059625553770	64
AX	28801670	4059625584248	64
AX	28802000	4059625553756	64
AX	28802140	4059625584866	64
AX	28802340	4059625584842	64
AX	28802670	4059625584255	64
AX	28802820	4059625584811	64
AX	28802990	4059625584804	64
36			
AX	36750000	4059625539705	75
AX	36750140	4059625552469	75
AX	36750340	4059625552452	75
AX	36750670	4059625552445	75
AX	36750700	4059625552438	75
AX	36750820	4059625552421	75
AX	36750990	4059625552414	75
AX	36751000	4059625539712	76
AX	36751140	4059625552407	76
AX	36751340	4059625552391	76
AX	36751670	4059625552384	76
AX	36751700	4059625552377	76
AX	36751820	4059625552360	76
AX	36751990	4059625552353	76
AX	36752000	4059625539729	75
AX	36752140	4059625552346	75
AX	36752340	4059625552339	75
AX	36752670	4059625552322	75
AX	36752820	4059625552315	75
AX	36752990	4059625552308	75
AX	36753000	4059625539736	76
AX	36753140	4059625551691	76
AX	36753340	4059625551684	76
AX	36753670	4059625552667	76
AX	36753820	4059625552650	76
AX	36753990	4059625552643	76
AX	36754000	4059625539743	75
AX	36754140	4059625552636	75
AX	36754340	4059625552629	75

Code Numbers and Trade Prices (HG = hansgrohe, AX = AXOR)

brand	Code no.	EAN	page
AX	36754670	4059625552612	75
AX	36754820	4059625552605	75
AX	36754990	4059625552599	75
AX	36755000	4059625539750	77
AX	36755140	4059625552582	77
AX	36755340	4059625552575	77
AX	36755670	4059625552568	77
AX	36755820	4059625552551	77
AX	36755990	4059625552544	77
AX	36756000	4059625539767	74
AX	36756140	4059625552537	74
AX	36756340	4059625552520	74
AX	36756670	4059625552513	74
AX	36756700	4059625552506	74
AX	36756820	4059625552490	74
AX	36756990	4059625552483	74
AX	36757000	4059625539774	74
AX	36757140	4059625552476	74
AX	36757340	4059625552841	74
AX	36757670	4059625552834	74
AX	36757820	4059625552827	74
AX	36757990	4059625552810	74
AX	36758000	4059625539781	74
AX	36758140	4059625552803	74
AX	36758340	4059625552797	74
AX	36758670	4059625552780	74
AX	36758820	4059625552773	74
AX	36758990	4059625552766	74
AX	36759000	4059625539798	77
AX	36759140	4059625552759	77
AX	36759340	4059625552742	77
AX	36759670	4059625552735	77
AX	36759700	4059625552728	77
AX	36759820	4059625552711	77
AX	36759990	4059625552704	77
AX	36774000	4059625539804	78
AX	36774140	4059625552698	78
AX	36774340	4059625552681	78
AX	36774670	4059625552674	78
AX	36774820	4059625553046	78
AX	36774990	4059625553039	78
AX	36775000	4059625539811	78
AX	36775140	4059625553022	78
AX	36775340	4059625553015	78
AX	36775670	4059625553008	78
AX	36775820	4059625552995	78
AX	36775990	4059625552988	78
AX	36776000	4059625539828	79
AX	36776140	4059625552971	79
AX	36776340	4059625552964	79
AX	36776670	4059625552957	79
AX	36776700	4059625552940	79
AX	36776820	4059625552933	79
AX	36776990	4059625552926	79
AX	36777000	4059625539835	79
AX	36777140	4059625552919	79
AX	36777340	4059625552902	79
AX	36777670	4059625552896	79
AX	36777820	4059625552889	79
AX	36777990	4059625552872	79
AX	36778000	4059625539842	79

brand	Code no.	EAN	page
AX	36778140	4059625552865	79
AX	36778340	4059625552858	79
AX	36778670	4059625553237	79
AX	36778820	4059625553220	79
AX	36778990	4059625553213	79
AX	36779000	4059625539859	80
AX	36779140	4059625553206	80
AX	36779340	4059625553190	80
AX	36779670	4059625553183	80
AX	36779700	4059625553176	80
AX	36779820	4059625553169	80
AX	36779990	4059625553152	80
AX	36780000	4059625539866	80
AX	36780140	4059625553145	80
AX	36780340	4059625553138	80
AX	36780670	4059625553121	80
AX	36780820	4059625553114	80
AX	36780990	4059625553107	80
AX	36781000	4059625539873	80
AX	36781140	4059625553091	80
AX	36781340	4059625553084	80
AX	36781670	4059625553077	80
AX	36781820	4059625553060	80
AX	36781990	4059625553053	80
49			
AX	49010000	4059625558409	48
AX	49010140	4059625558393	48
AX	49010340	4059625558386	48
AX	49010670	4059625558379	48
AX	49010820	4059625558362	48
AX	49010990	4059625558355	48
AX	49011000	4059625558348	48
AX	49011140	4059625558331	48
AX	49011340	4059625558324	48
AX	49011670	4059625558317	48
AX	49011820	4059625558300	48
AX	49011990	4059625558294	48
AX	49020000	4059625558287	48
AX	49020140	4059625558270	48
AX	49020340	4059625558263	48
AX	49020670	4059625558256	48
AX	49020820	4059625558249	48
AX	49020990	4059625558232	48
AX	49021000	4059625558225	49
AX	49021140	4059625558607	49
AX	49021340	4059625558591	49
AX	49021670	4059625558218	49
AX	49021820	4059625558584	49
AX	49021990	4059625558577	49
AX	49030000	4059625558560	49
AX	49030140	4059625558553	49
AX	49030340	4059625558546	49
AX	49030670	4059625558539	49
AX	49030820	4059625558522	49
AX	49030990	4059625558515	49
AX	49031000	4059625558508	49
AX	49031140	4059625558492	49
AX	49031340	4059625558485	49
AX	49031670	4059625558478	49
AX	49031820	4059625558461	49
AX	49031990	4059625558454	49

Code Numbers and Trade Prices (HG = hansgrohe, AX = AXOR)

brand	Code no.	EAN	page
AX	49040000	4059625558447	49
AX	49040140	4059625558805	49
AX	49040340	4059625558799	49
AX	49040670	4059625558430	49
AX	49040820	4059625558423	49
AX	49040990	4059625558416	49
AX	49041000	4059625558782	49
AX	49041140	4059625558775	49
AX	49041340	4059625558768	49
AX	49041670	4059625558751	49
AX	49041820	4059625558744	49
AX	49041990	4059625558737	49
AX	49050000	4059625558720	50
AX	49050140	4059625558713	50
AX	49050340	4059625558706	50
AX	49050670	4059625558690	50
AX	49050820	4059625558683	50
AX	49050990	4059625558676	50
AX	49051000	4059625558669	50
AX	49051140	4059625558652	50
AX	49051340	4059625558645	50
AX	49051670	4059625558638	50
AX	49051820	4059625558621	50
AX	49051990	4059625558614	50
AX	49060000	4059625559000	51
AX	49060140	4059625558997	51
AX	49060340	4059625558980	51
AX	49060670	4059625558973	51
AX	49060820	4059625558966	51
AX	49060990	4059625558959	51
AX	49061000	4059625558942	52
AX	49061140	4059625558935	52
AX	49061340	4059625558928	52
AX	49061670	4059625558911	52
AX	49061820	4059625558904	52
AX	49061990	4059625558898	52
AX	49070000	4059625558881	52
AX	49070140	4059625558874	52
AX	49070340	4059625558867	52
AX	49070670	4059625558850	52
AX	49070820	4059625558843	52
AX	49070990	4059625558836	52
AX	49071000	4059625558829	52
AX	49071140	4059625559208	52
AX	49071340	4059625559192	52
AX	49071670	4059625558812	52
AX	49071820	4059625559185	52
AX	49071990	4059625559178	52
AX	49110000	4059625559161	50
AX	49110140	4059625559154	50
AX	49110340	4059625559147	50
AX	49110670	4059625559130	50
AX	49110820	4059625559123	50
AX	49110990	4059625559116	50
AX	49111000	4059625559109	51
AX	49111140	4059625559093	51
AX	49111340	4059625559086	51
AX	49111670	4059625559079	51
AX	49111820	4059625559062	51
AX	49111990	4059625559055	51
AX	49210000	4059625559048	53

brand	Code no.	EAN	page
AX	49210140	4059625559406	53
AX	49210340	4059625559390	53
AX	49210670	4059625559031	53
AX	49210820	4059625559024	53
AX	49210990	4059625559017	53
AX	49211000	4059625559383	53
AX	49211140	4059625559376	53
AX	49211340	4059625559369	53
AX	49211670	4059625559352	53
AX	49211820	4059625559345	53
AX	49211990	4059625559338	53
AX	49410000	4059625559598	58
AX	49410140	4059625559581	58
AX	49410340	4059625559574	58
AX	49410670	4059625559567	58
AX	49410820	4059625559550	58
AX	49410990	4059625559543	58
AX	49430000	4059625559536	57
AX	49430140	4059625559529	57
AX	49430340	4059625559512	57
AX	49430670	4059625559505	57
AX	49430820	4059625559499	57
AX	49430990	4059625559482	57
AX	49431000	4059625559475	57
AX	49431140	4059625559468	57
AX	49431340	4059625559451	57
AX	49431670	4059625559444	57
AX	49431820	4059625559437	57
AX	49431990	4059625559420	57
AX	49440000	4059625559321	54
AX	49440140	4059625559314	54
AX	49440340	4059625559307	54
AX	49440670	4059625559291	54
AX	49440820	4059625559284	54
AX	49440990	4059625559277	54
AX	49441000	4059625559260	54
AX	49441140	4059625559253	54
AX	49441340	4059625559246	54
AX	49441670	4059625559239	54
AX	49441820	4059625559222	54
AX	49441990	4059625559215	54
AX	49449000	4059625559413	58
AX	49480000	4059625559741	55
AX	49480140	4059625559734	55
AX	49480340	4059625559727	55
AX	49480670	4059625559710	55
AX	49480820	4059625559703	55
AX	49480990	4059625559697	55
AX	49481000	4059625559680	55
AX	49481140	4059625559673	55
AX	49481340	4059625559666	55
AX	49481670	4059625559659	55
AX	49481820	4059625559642	55
AX	49481990	4059625559635	55
AX	49482000	4059625559628	56
AX	49482140	4059625559949	56
AX	49482340	4059625559932	56
AX	49482670	4059625559611	56
AX	49482820	4059625559925	56
AX	49482990	4059625559604	56
AX	49483000	4059625559918	56

brand	Code no.	EAN	page
AX	49483140	4059625559901	56
AX	49483340	4059625559895	56
AX	49483670	4059625559888	56
AX	49483820	4059625559871	56
AX	49483990	4059625559864	56
AX	49626000	4059625560082	65
AX	49626140	4059625560099	65
AX	49626340	4059625560105	65
AX	49626670	4059625560112	65
AX	49626820	4059625560129	65
AX	49626990	4059625560136	65
AX	49700000	4059625559857	59
AX	49700140	4059625559840	59
AX	49700340	4059625559833	59
AX	49700670	4059625559826	59
AX	49700820	4059625559819	59
AX	49700990	4059625559802	59
AX	49701000	4059625559796	59
AX	49701140	4059625560075	59
AX	49701340	4059625559789	59
AX	49701670	4059625559772	59
AX	49701820	4059625559765	59
AX	49701990	4059625559758	59
AX	49710000	4059625560068	60
AX	49710140	4059625560051	60
AX	49710340	4059625560044	60
AX	49710670	4059625560037	60
AX	49710820	4059625560020	60
AX	49710990	4059625560013	60
AX	49711000	4059625560006	60
AX	49711140	4059625559994	60
AX	49711340	4059625559987	60
AX	49711670	4059625559970	60
AX	49711820	4059625559963	60
AX	49711990	4059625559956	60

AXOR Citterio C





AXOR Citterio C: Contemporary, Sophisticated, Slender

Slender, elegant and exceptionally refined, AXOR Citterio C reinterprets the washbasin faucet for a new era, one that demands ever more comfort and individuality from ever smaller bathroom spaces. Minimalist in spirit, with soft contours and a sensuous form, the faucet invites the touch while intriguing the eye from every angle. Its signature detail, a fine chamfer encircling the outlet and lever handle, extends to all pieces in the collection. Distinctive yet understated, AXOR Citterio C is at home in any bathroom ambience. For those who wish to make a more personal statement, handles are available in the unique cubic cut pattern as standard and other predefined textured patterns via AXOR Signature Service, as well as in the full range of AXOR FinishPlus surfaces.

Design: Antonio Citterio

Single lever basin mixer 125 with CoolStart - cubic cut



AXOR Citterio C is distinguished by its slender verticality, its soft and sensuous form, its flat surfaces and its signature detail, a subtle chamfer that encircles every piece in the collection.

Overhead shower 270/270 1jet

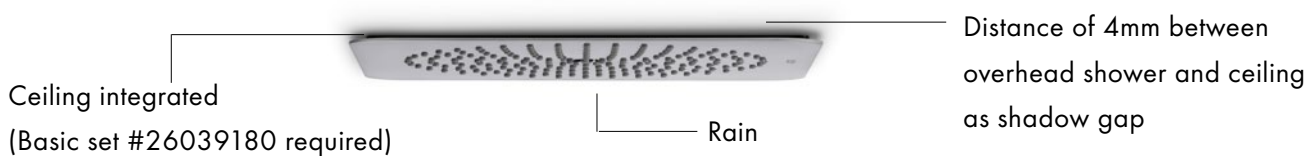
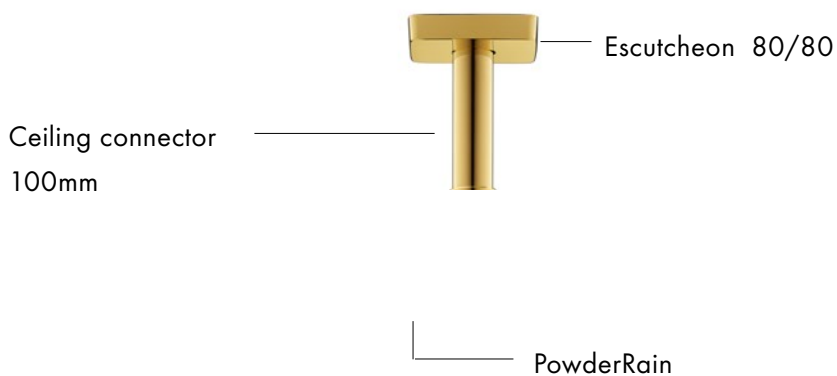
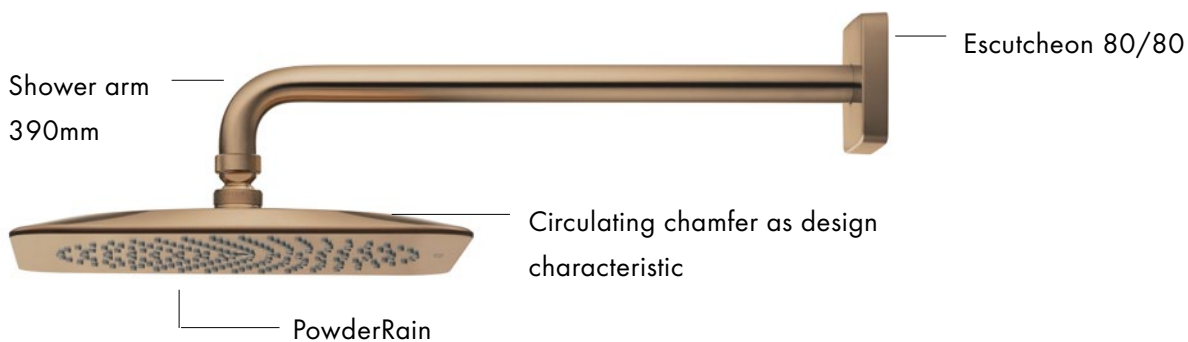

A wide range of products brings the subtle yet distinctive design language of AXOR Citterio C to every area of the bathroom.

AXOR Finishes

Surface colors from stock*



Chrome
-000

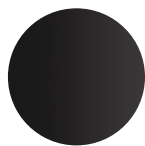

Matt Black
-670



Brushed Black Chrome
-340



Polished Gold Optic
-990

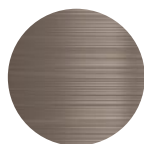

Brushed Nickel
-820



Brushed Bronze
-140

Surface colors with a production time of max. 6 weeks* (excl. transport)



Brushed Brass
-950



Brushed Gold Optic
-250

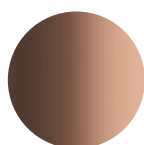

Polished Red Gold
-300



Brushed Red Gold
-310

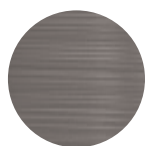

Stainless Steel Optic
-800



Polished Black Chrome
-330

*Please note that production times and stock availabilities are only valid for small quantities and may vary for project or bulk orders.

AXOR FinishPlus - the refinement of the unique

The exclusive surface finishes from AXOR FinishPlus set new standards, from the lacquered Matt Black surface to Polished Gold Optic and Brushed Black Chrome. Surfaces of exceptional brilliance, robustness, and durability, manufactured in Germany to the highest technical standards – from single pieces to large quantities. AXOR FinishPlus PVD surface finishes have character. Each color is the result of intensive development and refined in AXOR's vacuum chambers using the PVD (physical vapor deposition) process. An electric arc discharges in the high vacuum, gases combine with zirconium. The mixture hits the faucet's chrome surface. This high-tech process gives the surface unprecedented brilliance and high resistance to scratches, cleaning agents, and the salt of the sea air.



AXOR Signature Service - AXOR Citterio C

AXOR Signature is an exclusive service that takes a design object and makes it one-of-a-kind, whether by providing each mixer with the customer's personal touch or by modifying it to fit specific dimensions. The personal and customized result manufactured by AXOR experts in Schiltach. With the utmost in care and precise craftsmanship in accordance with industrial standards.

Bi-color

A contrasting bi-color finish provides AXOR Citterio C a contemporary, elegant twist, emphasizing the poetic form of its handle and pairing especially well with an elegant handle engraving. A bi-color finish offers an individual, contemporary twist on the collection's timeless, elegant design.



Polished Black Chrome body with Polished Gold Optic handle and ball-joint. Individualization possibilities are also available for Dummy products.

To request the customized Bi-color product via the AXOR Signature Service, the order consists of a detailed description of each product part and the desired finish.

Ball joint

e.g. Polished Gold Optic
- 990

Handle

e.g. Polished Gold Optic
- 990

Handle escutcheon

e.g. Polished Black Chrome
- 330

Aerator case

e.g. Polished Black Chrome
- 330

Product body

e.g. Polished Black Chrome
- 330

Escutcheon

e.g. Polished Black Chrome
- 330



Handle structures

AXOR Citterio C is pushing the boundaries of individualization with the possibility to choose a textured pattern for the handle. In addition to the optional cubic cut, AXOR Signature offers three pre-defined structures: the soft cut, the rhombic cut and the linear cut for an even more personalized bathroom.



Soft cut



Rhombic cut



Linear cut

In addition to the structure options offered as standard, the cubic pattern is available in fully-structured surface for "one-handle" arrangements and partially-structured surface for "two-handle" arrangements.



Cubic cut - half structured
Standard product



Cubic cut - fully structured
AXOR Signature application

Example representation of an individualization service. Further individualization options are possible through AXOR Signature Service.

Individualization possibilities are also available for dummy products.

Single lever basin mixers CoolStart

Features of all variants

/ consists of: single lever basin mixer, waste set
 / handle variant: lever handle
 / spray type: normal spray
 / maximum flow rate at 3 bar: 5 l/min

/ ceramic cartridge
 / suitable for continuous flow water heaters
 / connection type: G 3/8 connections
 / connection dimension: DN15

/ cold water in basic handle position
 / EU taxonomy: max. 6 l/min - Substantial Contribution (SC) possible

90

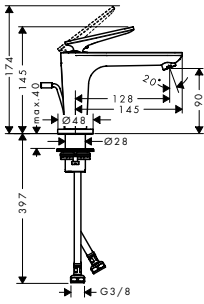

125 cubic cut

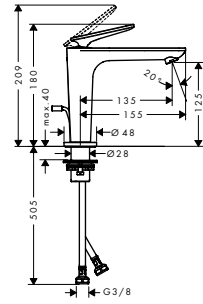

250

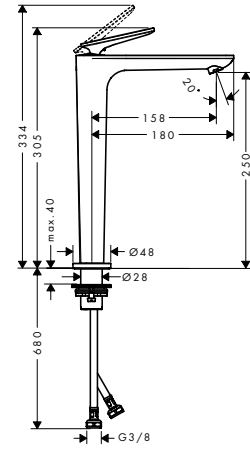

Sustainability



Technologies













































Overview variants

ComfortZone	Projection (mm)	Spout height (mm)	Waste set	For wash bowls	Structure element	Finish	Available from	Code no.
90	128	90	pop-up	-	without structure	Chrome	Q2/2024	49010000
						Brushed Bronze	Q2/2024	49010140
						Brushed Black Chrome	Q2/2024	49010340
						Matt Black	Q2/2024	49010670
						Brushed Nickel	Q2/2024	49010820
						Polished Gold Optic	Q2/2024	49010990
						AXOR FinishPlus*		49010XXX
						AXOR FinishPlus*		49011XXX
90	128	90	pop-up	-	cubic cut	Chrome	Q2/2024	49011000
						Brushed Bronze	Q2/2024	49011140
						Brushed Black Chrome	Q2/2024	49011340
						Matt Black	Q2/2024	49011670
						Brushed Nickel	Q2/2024	49011820
						Polished Gold Optic	Q2/2024	49011990
						AXOR FinishPlus*		49011XXX
						AXOR FinishPlus*		49011XXX
90	128	90	non-closing	-	without structure	Chrome	Q2/2024	49020000
						Brushed Bronze	Q2/2024	49020140
						Brushed Black Chrome	Q2/2024	49020340
						Matt Black	Q2/2024	49020670
						Brushed Nickel	Q2/2024	49020820
						Polished Gold Optic	Q2/2024	49020990
						AXOR FinishPlus*		49020XXX
						AXOR FinishPlus*		49020XXX
90	128	90	non-closing	-	cubic cut	Chrome	Q2/2024	49021000
						Brushed Bronze	Q2/2024	49021140
						Brushed Black Chrome	Q2/2024	49021340
						Matt Black	Q2/2024	49021670
						Brushed Nickel	Q2/2024	49021820
						Polished Gold Optic	Q2/2024	49021990
						AXOR FinishPlus*		49021XXX
						AXOR FinishPlus*		49021XXX

Measurements within scale drawings are in mm. Technical specifications and units of measure are subject to change.

Single lever basin mixers CoolStart

Overview variants

ComfortZone	Projection (mm)	Spout height (mm)	Waste set	For wash bowls	Structure element	Finish	Available from	Code no.
125	135	125	pop-up	-	without structure	 Chrome	Q2/2024	49030000
						 Brushed Bronze	Q2/2024	49030140
						 Brushed Black Chrome	Q2/2024	49030340
						 Matt Black	Q2/2024	49030670
						 Brushed Nickel	Q2/2024	49030820
						 Polished Gold Optic	Q2/2024	49030990
						 AXOR FinishPlus*		49030XXX
125	135	125	pop-up	-	cubic cut	 Chrome	Q2/2024	49031000
						 Brushed Bronze	Q2/2024	49031140
						 Brushed Black Chrome	Q2/2024	49031340
						 Matt Black	Q2/2024	49031670
						 Brushed Nickel	Q2/2024	49031820
						 Polished Gold Optic	Q2/2024	49031990
						 AXOR FinishPlus*		49031XXX
125	135	125	non-closing	-	without structure	 Chrome	Q2/2024	49040000
						 Brushed Bronze	Q2/2024	49040140
						 Brushed Black Chrome	Q2/2024	49040340
						 Matt Black	Q2/2024	49040670
						 Brushed Nickel	Q2/2024	49040820
						 Polished Gold Optic	Q2/2024	49040990
						 AXOR FinishPlus*		49040XXX
125	135	125	non-closing	-	cubic cut	 Chrome	Q2/2024	49041000
						 Brushed Bronze	Q2/2024	49041140
						 Brushed Black Chrome	Q2/2024	49041340
						 Matt Black	Q2/2024	49041670
						 Brushed Nickel	Q2/2024	49041820
						 Polished Gold Optic	Q2/2024	49041990
						 AXOR FinishPlus*		49041XXX
250	158	250	non-closing	■	without structure	 Chrome	Q2/2024	49050000
						 Brushed Bronze	Q2/2024	49050140
						 Brushed Black Chrome	Q2/2024	49050340
						 Matt Black	Q2/2024	49050670
						 Brushed Nickel	Q2/2024	49050820
						 Polished Gold Optic	Q2/2024	49050990
						 AXOR FinishPlus*		49050XXX
250	158	250	non-closing	■	cubic cut	 Chrome	Q2/2024	49051000
						 Brushed Bronze	Q2/2024	49051140
						 Brushed Black Chrome	Q2/2024	49051340
						 Matt Black	Q2/2024	49051670
						 Brushed Nickel	Q2/2024	49051820
						 Polished Gold Optic	Q2/2024	49051990
						 AXOR FinishPlus*		49051XXX

Single lever basin mixers for concealed installation wall-mounted

Features of all variants

- / consists of: single lever basin mixer for concealed installation wall-mounted, waste set
- / projection: 193 mm
- / handle variant: lever handle
- / spray type: normal spray
- / maximum flow rate at 3 bar: 5 l/min
- / ceramic cartridge
- / suitable for continuous flow water heaters
- / non-closing waste set
- / connection type: basic set
- / connection dimension: DN15
- / handle can be positioned on the right or left, depending on the basic set installation
- / EU taxonomy: max. 6 l/min - Substantial Contribution (SC) possible

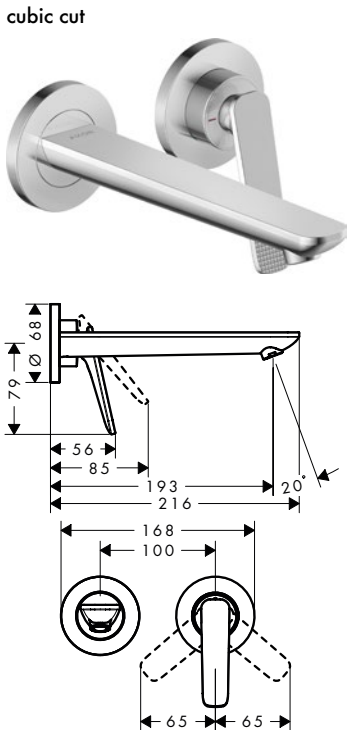
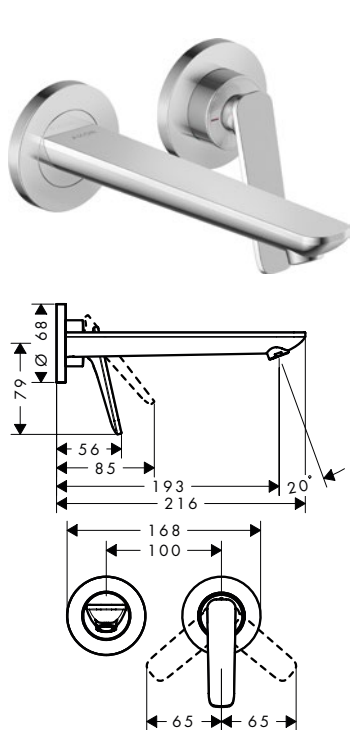

Sustainability **Technologies**

Overview variants

Projection (mm)	Structure element	Finish	Available from	Code no.
193	without structure	Chrome	Q2/2024	49110000
		Brushed Bronze	Q2/2024	49110140
		Brushed Black Chrome	Q2/2024	49110340
		Matt Black	Q2/2024	49110670
		Brushed Nickel	Q2/2024	49110820
		Polished Gold Optic	Q2/2024	49110990
		AXOR FinishPlus*		49110XXX
193	cubic cut	Chrome	Q2/2024	49111000
		Brushed Bronze	Q2/2024	49111140
		Brushed Black Chrome	Q2/2024	49111340
		Matt Black	Q2/2024	49111670
		Brushed Nickel	Q2/2024	49111820
		Polished Gold Optic	Q2/2024	49111990
		AXOR FinishPlus*		49111XXX

Required parts:		Code no.
	Basic set for single lever basin mixer for concealed installation wall-mounted	13623180
Optional parts:		Code no.
	Extension set 25 mm for single lever basin mixer wall-mounted	13586000

Measurements within scale drawings are in mm. Technical specifications and units of measure are subject to change.

3-hole basin mixers

Features of all variants

/ consists of: 3-hole basin mixer, waste set
 / ComfortZone 125
 / projection: 135 mm
 / spout height: 125 mm
 / handle variant: lever handle

/ spray type: normal spray
 / maximum flow rate at 3 bar: 5 l/min
 / ceramic valves hot/cold 90°
 / suitable for continuous flow water heaters
 / pop-up waste set G 1¼

/ connection type: G ¾ connections
 / connection dimension: DN15
 / EU taxonomy: max. 6 l/min - Substantial Contribution (SC) possible

125

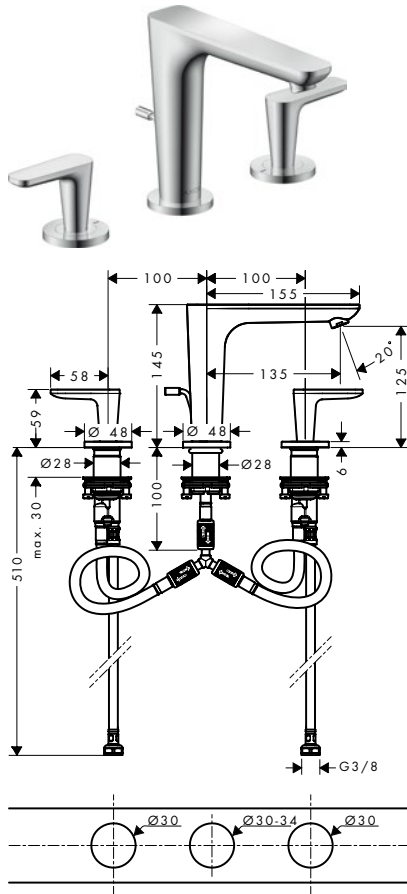

125 cubic cut

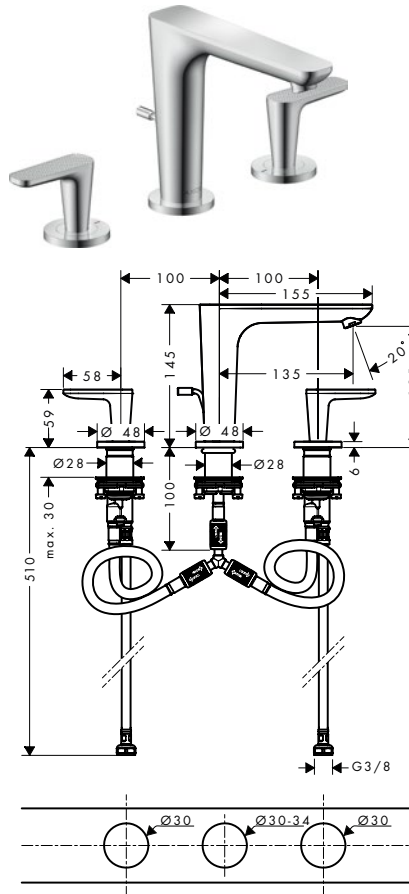

Sustainability



Technologies



Overview variants

ComfortZone	Projection (mm)	Spout height (mm)	Structure element	Finish	Available from	Code no.
125	135	125	without structure	Chrome	Q2/2024	49060000
				Brushed Bronze	Q2/2024	49060140
				Brushed Black Chrome	Q2/2024	49060340
				Matt Black	Q2/2024	49060670
				Brushed Nickel	Q2/2024	49060820
				Polished Gold Optic	Q2/2024	49060990
				AXOR FinishPlus*		49060XXX
				AXOR FinishPlus*		49060XXX
125	135	125	cubic cut	Chrome	Q2/2024	49061000
				Brushed Bronze	Q2/2024	49061140
				Brushed Black Chrome	Q2/2024	49061340
				Matt Black	Q2/2024	49061670
				Brushed Nickel	Q2/2024	49061820
				Polished Gold Optic	Q2/2024	49061990
				AXOR FinishPlus*		49061XXX
				AXOR FinishPlus*		49061XXX

*AXOR FinishPlus: For further AXOR FinishPlus surfaces please see the AXOR FinishPlus overview on page 27.

3-hole basin mixers for concealed installation wall-mounted

Features of all variants

/ consists of: 3-hole basin mixer for concealed installation wall-mounted, waste set
 / projection: 193 mm
 / handle variant: lever handle
 / spray type: normal spray

/ maximum flow rate at 3 bar: 5 l/min
 / ceramic valves hot/cold 90°
 / suitable for continuous flow water heaters
 / non-closing waste set
 / connection type: basic set

/ connection dimension: DN15
 / EU taxonomy: max. 6 l/min - Substantial Contribution (SC) possible

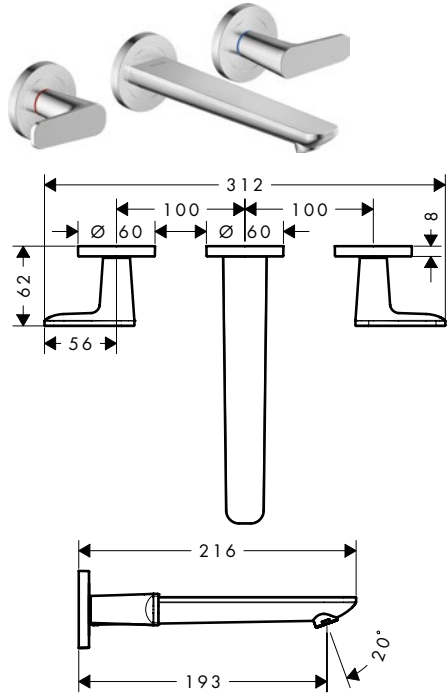

cubic cut

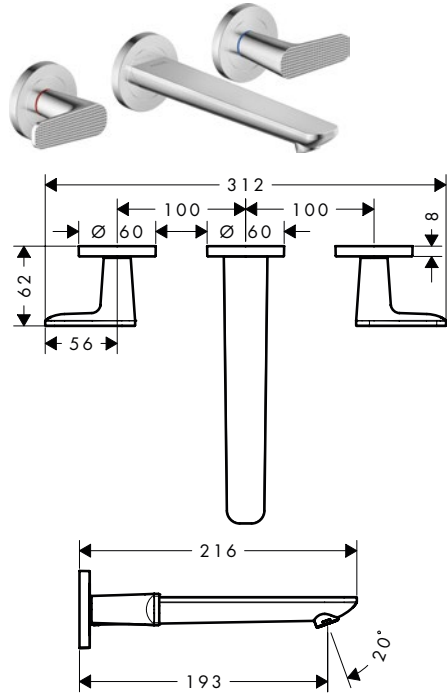

Sustainability



Technologies





Overview variants

Projection (mm)	Structure element	Finish	Available from	Code no.
193	without structure	Chrome	Q2/2024	49070000
		Brushed Bronze	Q2/2024	49070140
		Brushed Black Chrome	Q2/2024	49070340
		Matt Black	Q2/2024	49070670
		Brushed Nickel	Q2/2024	49070820
		Polished Gold Optic	Q2/2024	49070990
		AXOR FinishPlus*		49070XXX
		193	cubic cut	Chrome
Brushed Bronze	Q2/2024			49071140
Brushed Black Chrome	Q2/2024			49071340
Matt Black	Q2/2024			49071670
Brushed Nickel	Q2/2024			49071820
Polished Gold Optic	Q2/2024			49071990
AXOR FinishPlus*				49071XXX

Required parts:

	Basic set for 3-hole basin mixer for concealed installation wall-mounted	Code no. 10303180
--	--	----------------------

3-hole basin mixers for concealed installation wall-mounted

Optional parts:		Code no.
	Seal	96383000
	Extension set 25 mm for basic set for 3-hole basin mixer wall-mounted	96259000

Single lever bidet mixers

Features of all variants







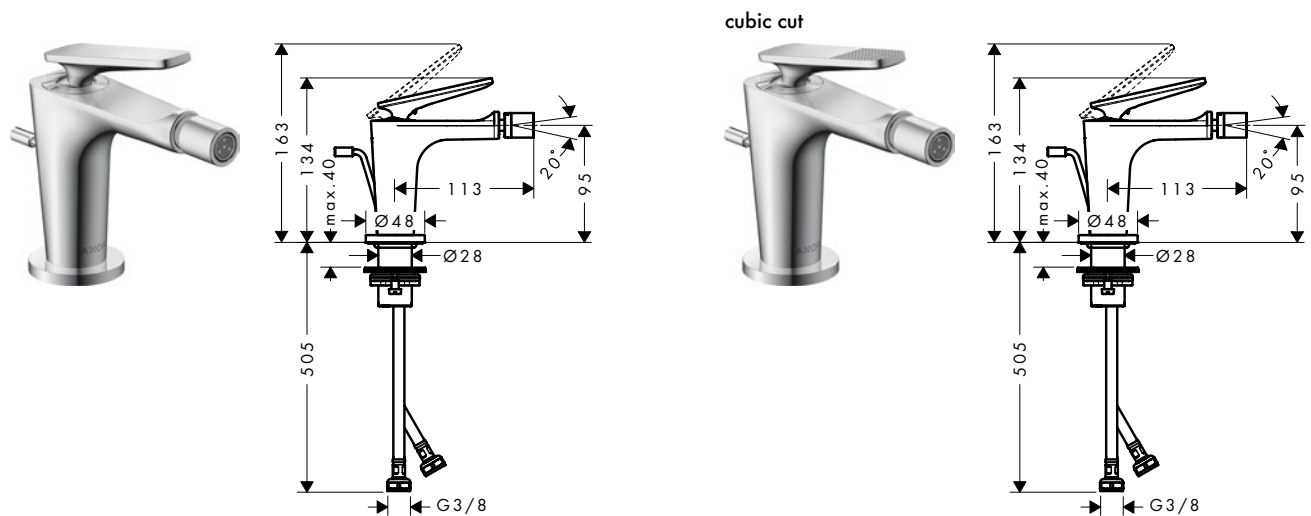







/ consists of: single lever bidet mixer, waste set
 / projection: 113 mm
 / spout height: 95 mm
 / ball-pivot joint

/ spray type: laminar spray
 / maximum flow rate at 3 bar: 7,5 l/min
 / ceramic cartridge
 / suitable for continuous flow water heaters

/ pop-up waste set G 1 1/4
 / connection type: G 3/8 connections
 / connection dimension: DN15



Overview variants

Structure element	Finish	Available from	Code no.
without structure	 Chrome	Q2/2024	49210000
	 Brushed Bronze	Q2/2024	49210140
	 Brushed Black Chrome	Q2/2024	49210340
	 Matt Black	Q2/2024	49210670
	 Brushed Nickel	Q2/2024	49210820
	 Polished Gold Optic	Q2/2024	49210990
	 AXOR FinishPlus*		49210XXX
cubic cut	 Chrome	Q2/2024	49211000
	 Brushed Bronze	Q2/2024	49211140
	 Brushed Black Chrome	Q2/2024	49211340
	 Matt Black	Q2/2024	49211670
	 Brushed Nickel	Q2/2024	49211820
	 Polished Gold Optic	Q2/2024	49211990
	 AXOR FinishPlus*		49211XXX

*AXOR FinishPlus: For further AXOR FinishPlus surfaces please see the AXOR FinishPlus overview on page 27.

Single lever bath mixers floor-standing

Features of all variants

- / consists of: single lever bath mixer floor standing, baton hand shower, shower hose, shower holder
- / 2 functions
- / projection: 194 mm
- / spray type mixer: laminar spray
- / maximum flow rate at 3 bar: 23,4 l/min
- / flow rate for bath spout at 3 bar: 23,4 l/min
- / M35 S
- / diverter with automatic resetting
- / non-return valve
- / connection dimension: DN15
- / connection type: basic set
- / deck mounted installation
- / min. operating pressure: 1 bar
- / max. operating pressure: 10 bar

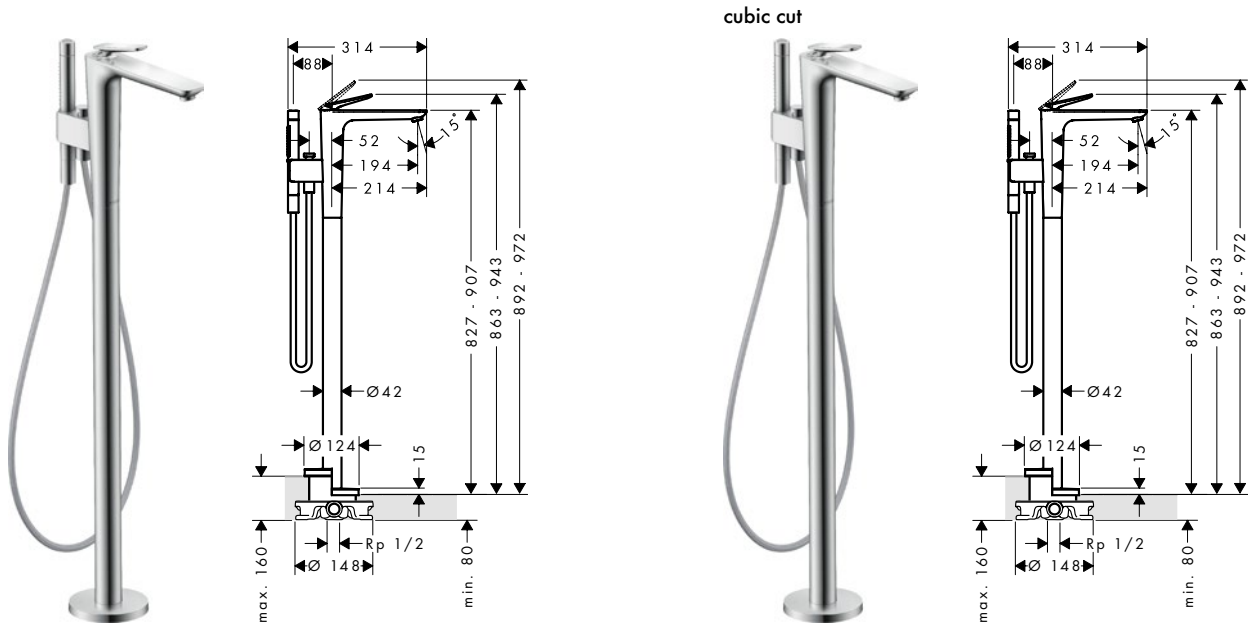

Spray types



Overview variants

Projection (mm)	Structure element	Finish	Available from	Code no.		
194	without structure	Chrome	Q2/2024	49440000		
		Brushed Bronze	Q2/2024	49440140		
		Brushed Black Chrome	Q2/2024	49440340		
		Matt Black	Q2/2024	49440670		
		Brushed Nickel	Q2/2024	49440820		
		Polished Gold Optic	Q2/2024	49440990		
		194	cubic cut	Chrome	Q2/2024	49441000
				Brushed Bronze	Q2/2024	49441140
				Brushed Black Chrome	Q2/2024	49441340
				Matt Black	Q2/2024	49441670
194	cubic cut	Brushed Nickel	Q2/2024	49441820		
		Polished Gold Optic	Q2/2024	49441990		

Required parts:		Code no.
	Basic set for mixers floor-standing	10452180
Optional parts:		Code no.
	Sealing foil for basic set bath mixer floor-standing	96441000
	Extension 60 mm for pipe	93882000

Measurements within scale drawings are in mm. Technical specifications and units of measure are subject to change.

3-hole bath mixer for concealed installation wall-mounted with hand shower

Features of all variants

/ 2 functions
 / projection: 222 mm
 / spray type mixer: normal spray
 / spray type hand shower: Rain, Mono

/ flow rate for bath spout at 3 bar: 20 l/min
 / flow rate of hand shower at 3 bar: 9,7 l/min
 / diverter with automatic resetting
 / connection dimension: DN15

/ connection type: basic set
 / wall-mounted
 / min. operating pressure: 1 bar
 / max. operating pressure: 10 bar

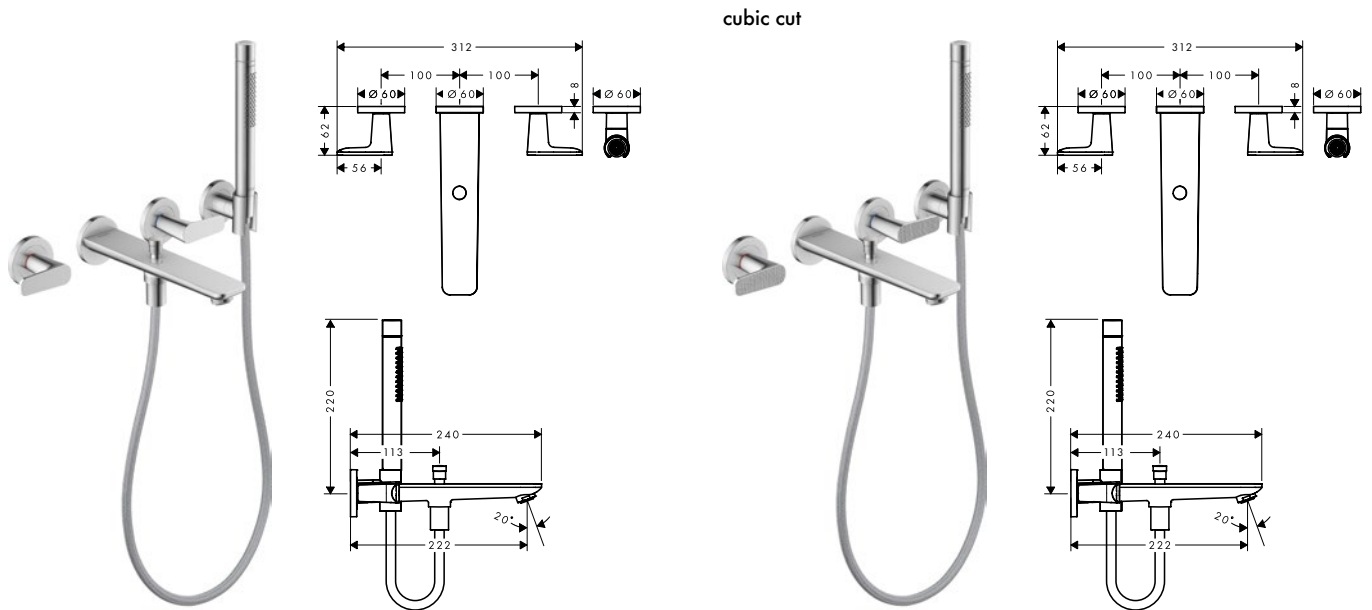

Spray types



Technologies



Overview variants

Projection (mm)	Structure element	Finish	Available from	Code no.
222	without structure	Chrome	Q2/2024	49480000
		Brushed Bronze	Q2/2024	49480140
		Brushed Black Chrome	Q2/2024	49480340
		Matt Black	Q2/2024	49480670
		Brushed Nickel	Q2/2024	49480820
222	cubic cut	Polished Gold Optic	Q2/2024	49480990
		Chrome	Q2/2024	49481000
		Brushed Bronze	Q2/2024	49481140
		Brushed Black Chrome	Q2/2024	49481340
		Matt Black	Q2/2024	49481670
		Brushed Nickel	Q2/2024	49481820
		Polished Gold Optic	Q2/2024	49481990
		AXOR FinishPlus*		49481XXX

Required parts:



Basic set for 3-hole basin mixer for concealed installation wall-mounted

Code no.

10303180

Optional parts:



Extension set 25 mm for basic set for 3-hole basin mixer wall-mounted

Code no.

96259000



Seal

96383000

* AXOR FinishPlus: For further AXOR FinishPlus surfaces please see the AXOR FinishPlus overview on page 27.

3-hole bath mixer for concealed installation wall-mounted

Features of all variants

/ 1 function
 / projection: 222 mm
 / spray type mixer: normal spray
 / maximum flow rate at 3 bar: 20 l/min

/ flow rate for bath spout at 3 bar: 20 l/min
 / ceramic valves hot/cold 90°
 / connection type: basic set
 / wall-mounted

/ min. operating pressure: 1 bar
 / max. operating pressure: 10 bar

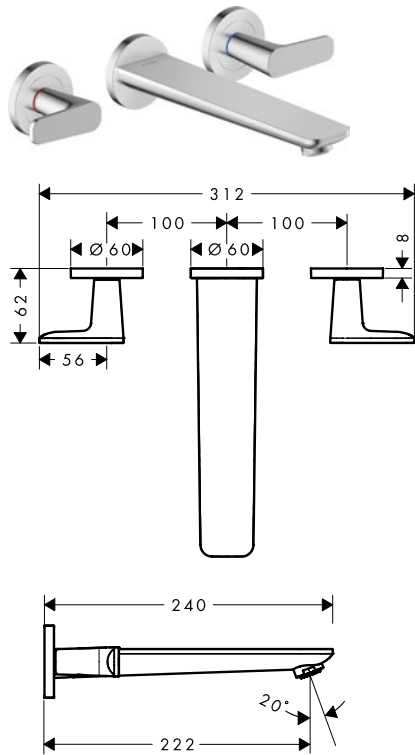

cubic cut

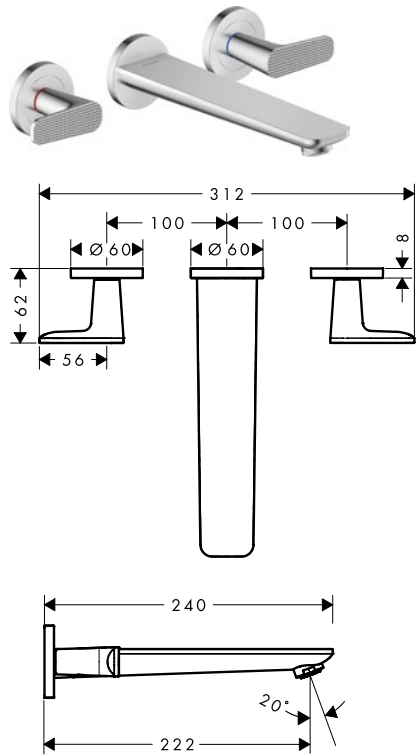

Technologies



Overview variants

Projection (mm)	Structure element	Finish	Available from	Code no.
222	without structure	Chrome	Q2/2024	49482000
		Brushed Bronze	Q2/2024	49482140
		Brushed Black Chrome	Q2/2024	49482340
		Matt Black	Q2/2024	49482670
		Brushed Nickel	Q2/2024	49482820
		Polished Gold Optic	Q2/2024	49482990
222	cubic cut	Chrome	Q2/2024	49483000
		Brushed Bronze	Q2/2024	49483140
		Brushed Black Chrome	Q2/2024	49483340
		Matt Black	Q2/2024	49483670
		Brushed Nickel	Q2/2024	49483820
		Polished Gold Optic	Q2/2024	49483990

Required parts:		Code no.
	Basic set for 3-hole basin mixer for concealed installation wall-mounted	10303180

Optional parts:		Code no.
	Seal	96383000
	Extension set 25 mm for basic set for 3-hole basin mixer wall-mounted	96259000

3-hole rim mounted single lever bath mixers

Features of all variants

/ consists of: 3-hole rim mounted single lever bath mixer, baton hand shower, shower holder
 / 2 functions
 / projection: 155 mm
 / spray type mixer: normal spray
 / spray type hand shower: Rain, Mono

/ maximum pull-out length of hand shower: 1,45 m
 / sBox for quiet, smooth and protected hose guidance
 / M35L
 / temperature limitation adjustable
 / non-return valve

/ connection dimension: DN15
 / connection type: basic set
 / installation on bath rim
 / min. operating pressure: 1 bar
 / max. operating pressure: 10 bar

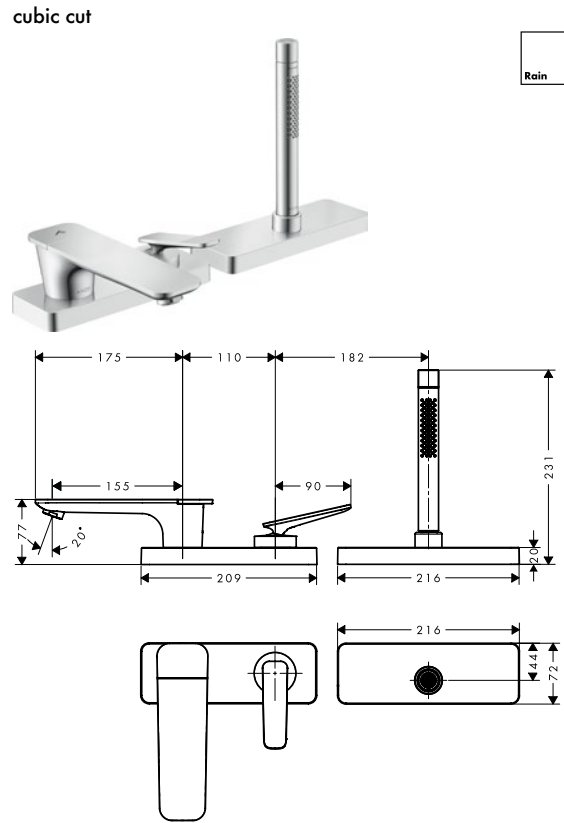
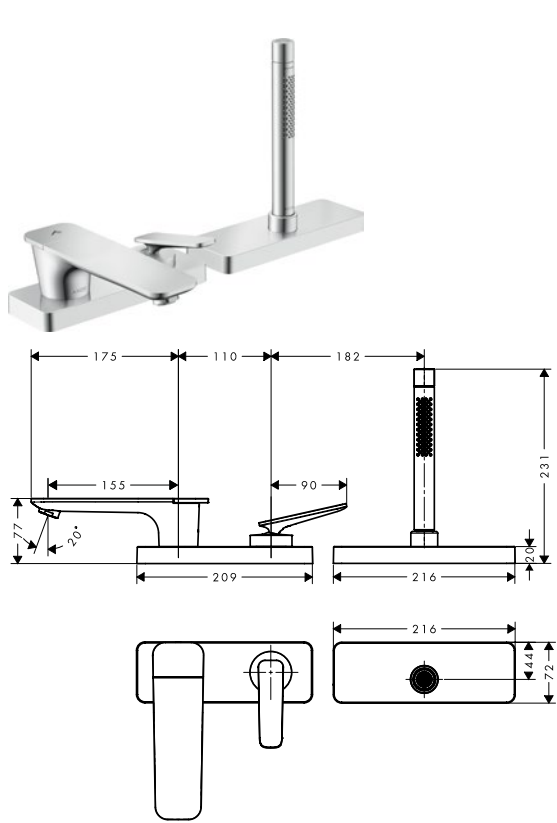

Spray types



Technologies



Overview variants

Projection (mm)	Structure element	Finish	Available from	Code no.
155	without structure	Chrome	Q2/2024	49430000
		Brushed Bronze	Q2/2024	49430140
		Brushed Black Chrome	Q2/2024	49430340
		Matt Black	Q2/2024	49430670
		Brushed Nickel	Q2/2024	49430820
		Polished Gold Optic	Q2/2024	49430990
155	cubic cut	Chrome	Q2/2024	49431000
		Brushed Bronze	Q2/2024	49431140
		Brushed Black Chrome	Q2/2024	49431340
		Matt Black	Q2/2024	49431670
		Brushed Nickel	Q2/2024	49431820
		Polished Gold Optic	Q2/2024	49431990

Required parts:



Basic set for 3-hole rim mounted single lever bath mixer

Code no.

15487180

Optional parts:



Installation plate

Code no.

49449000

Installation plate

Features

- / installation: indispensable for rim mounted mixers with plate
- / material: metal
- / installation type: concealed installation

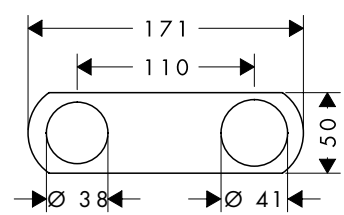
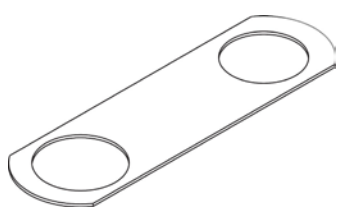

Available from	Code no.
Q2/2024	49449000

Finish set softsquare

Features

- / consists of: hose box, shower hose, escutcheon
- / suitable for rim or tile mounted installation
- / 1 function
- / sBox for quiet, smooth and protected hose guidance
- / connection dimension: DN15
- / no additional maintenance opening required
- / bath rim width at least 80 mm
- / clamping range: 0 - 30 mm
- / maximum pull-out length of hand shower 1.45 m
- / removable for service at any time
- / protected against backflow, according to DIN EN 1717
- / maximum flow rate at 3 bar: 9,5 l/min

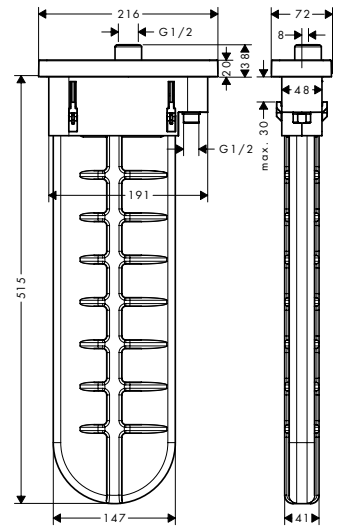

Finish	Available from	Code no.
Chrome	Q2/2024	28017000
Brushed Bronze	Q2/2024	28017140
Brushed Black Chrome	Q2/2024	28017340
Matt Black	Q2/2024	28017670
Brushed Nickel	Q2/2024	28017820
Polished Gold Optic	Q2/2024	28017990
AXOR FinishPlus*		28017XXX

Bath spout

Features

- / 1 function
- / projection: 222 mm
- / maximum flow rate at 3 bar: 22 l/min
- / connection dimension: DN20
- / spray type: normal spray

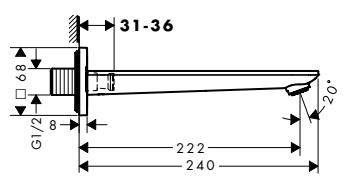
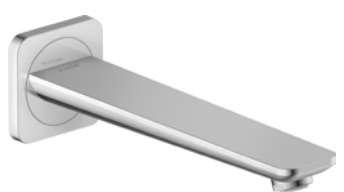

Technologies

Finish	Available from	Code no.
Chrome	Q2/2024	49410000
Brushed Bronze	Q2/2024	49410140
Brushed Black Chrome	Q2/2024	49410340
Matt Black	Q2/2024	49410670
Brushed Nickel	Q2/2024	49410820
Polished Gold Optic	Q2/2024	49410990
AXOR FinishPlus*		49410XXX

Measurements within scale drawings are in mm. Technical specifications and units of measure are subject to change.

Thermostatic modules concealed installation with plate

Features of all variants

/ 2 functions
 / simultaneous utilization of 2 functions
 / T42K
 / maximum flow rate at 3 bar: 42 l/min
 / flow rate upper outlet: 42 l/min

/ flow rate lower outlet: 40 l/min
 / min. operating pressure: 1 bar
 / max. operating pressure: 10 bar

/ combination of highflow thermostat with shut-off valve and Duo diverter valve for controlling 2 consumers
 / Safety stop at 40 °C
 / temperature limitation adjustable

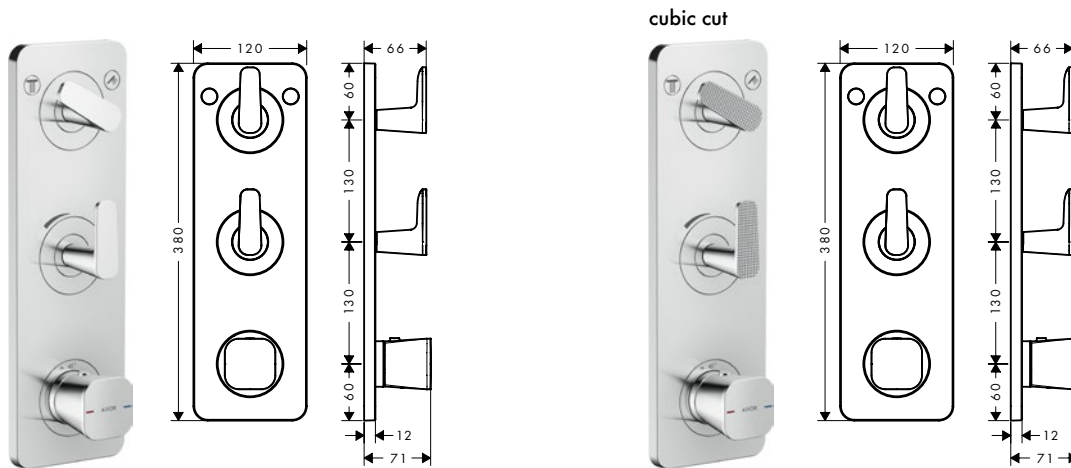

Sustainability



Technologies



Overview variants

Structure element	Finish	Available from	Code no.
without structure	Chrome	Q2/2024	49700000
	Brushed Bronze	Q2/2024	49700140
	Brushed Black Chrome	Q2/2024	49700340
	Matt Black	Q2/2024	49700670
	Brushed Nickel	Q2/2024	49700820
	Polished Gold Optic	Q2/2024	49700990
	AXOR FinishPlus*		49700XXX
	cubic cut	Chrome	Q2/2024
Brushed Bronze		Q2/2024	49701140
Brushed Black Chrome		Q2/2024	49701340
Matt Black		Q2/2024	49701670
Brushed Nickel		Q2/2024	49701820
Polished Gold Optic		Q2/2024	49701990
AXOR FinishPlus*			49701XXX

⚠ Required parts:

Basic set for thermostatic module 380/120 for concealed installation for 2 functions

 Code no.
36701180

Thermostatic modules concealed installation with escutcheons

Features of all variants

- / consists of: shower thermostat, shut-off/ diverter valve, shut-off valve
- / 3 functions
- / simultaneous utilization of 2 functions
- / T42K
- / maximum flow rate at 3 bar: 42 l/min
- / flow rate lower outlet: 37,9 l/min

- / Flow rate left and right: 37,9 l/min
- / min. operating pressure: 1 bar
- / max. operating pressure: 10 bar
- / combination of highflow thermostat with shut-off valve and Quattro diverter valve for controlling 3 consumers
- / Safety stop at 40 °C

- / temperature limitation adjustable
- / connection dimension: DN20
- / connection type: basic set

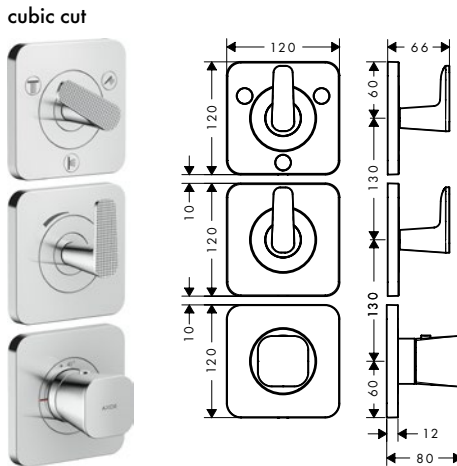
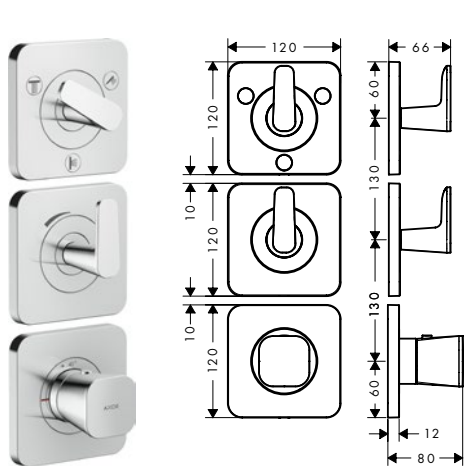

Sustainability



Technologies



Overview variants

Structure element	Finish	Available from	Code no.
without structure	Chrome	Q2/2024	49710000
	Brushed Bronze	Q2/2024	49710140
	Brushed Black Chrome	Q2/2024	49710340
	Matt Black	Q2/2024	49710670
	Brushed Nickel	Q2/2024	49710820
	Polished Gold Optic	Q2/2024	49710990
	AXOR FinishPlus*		49710XXX
	cubic cut	Chrome	Q2/2024
Brushed Bronze		Q2/2024	49711140
Brushed Black Chrome		Q2/2024	49711340
Matt Black		Q2/2024	49711670
Brushed Nickel		Q2/2024	49711820
Polished Gold Optic		Q2/2024	49711990
AXOR FinishPlus*			49711XXX

Required parts:



Basic set for thermostatic module 380/120 for concealed installation for 3 functions

Code no.

36708180

Overhead showers 1 jet with shower arm

Features of all variants

/ consists of: overhead shower, shower arm
 / shower head size: 270 x 270 mm
 / spray type: PowderRain

/ material spray disc: metal
 / shower arm length 390 mm
 / overhead shower removable for cleaning

/ installation: wall
 / connection thread G 1/2
 / suitable for continuous flow water heaters

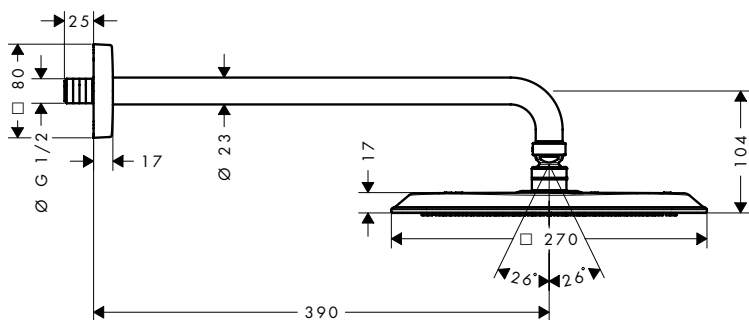

Sustainability



Technologies



Spray types



Overview variants

Shower head size	Number of sprays	Spray types	Max. flow rate at 3 bar (l/min)	Min. flow pressure (bar)	Finish	Available from	Code no.
270/270	1	PowderRain	6.5	1.5	Chrome	Q2/2024	28791000
					Brushed Bronze	Q2/2024	28791140
					Brushed Black Chrome	Q2/2024	28791340
					Matt Black	Q2/2024	28791670
					Brushed Nickel	Q2/2024	28791820
					Polished Gold Optic	Q2/2024	28791990
					AXOR FinishPlus*		28791XXX
					AXOR FinishPlus*		28791XXX
270/270	1	PowderRain	11	1	Chrome	Q2/2024	28790000
					Brushed Bronze	Q2/2024	28790140
					Brushed Black Chrome	Q2/2024	28790340
					Matt Black	Q2/2024	28790670
					Brushed Nickel	Q2/2024	28790820
					Polished Gold Optic	Q2/2024	28790990
					AXOR FinishPlus*		28790XXX
					AXOR FinishPlus*		28790XXX

Optional parts:



Wall escutcheon 120/120 softsquare

Finish	Code no.
Chrome	28801000
Matt Black	28801670
AXOR FinishPlus*	28801XXX

Overhead showers 1 jet with ceiling connector

Features of all variants

/ consists of: overhead shower, ceiling connector
 / shower head size: 270 x 270 mm
 / spray type: PowderRain

/ material spray disc: metal
 / ceiling connection length: 100 mm
 / overhead shower removable for cleaning

/ installation: ceiling
 / connection thread G 1/2
 / suitable for continuous flow water heaters

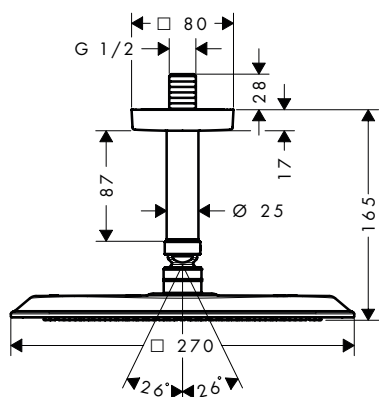

Sustainability



Technologies



Spray types



Overview variants

Shower head size	Number of sprays	Spray types	Max. flow rate at 3 bar (l/min)	Min. flow pressure (bar)	Finish	Available from	Code no.
270/270	1	PowderRain	6.5	1.5	Chrome	Q2/2024	28793000
					Brushed Bronze	Q2/2024	28793140
					Brushed Black Chrome	Q2/2024	28793340
					Matt Black	Q2/2024	28793670
					Brushed Nickel	Q2/2024	28793820
					Polished Gold Optic	Q2/2024	28793990
					AXOR FinishPlus*		28793XXX
					AXOR FinishPlus*		28792000
270/270	1	PowderRain	11	1	Chrome	Q2/2024	28792000
					Brushed Bronze	Q2/2024	28792140
					Brushed Black Chrome	Q2/2024	28792340
					Matt Black	Q2/2024	28792670
					Brushed Nickel	Q2/2024	28792820
					Polished Gold Optic	Q2/2024	28792990
					AXOR FinishPlus*		28792XXX
					AXOR FinishPlus*		28792XXX

Optional parts:

Ceiling escutcheon 120/120 softsquare



Finish	Code no.
Chrome	28802000
Brushed Bronze	28802140
Brushed Black Chrome	28802340
Matt Black	28802670
Brushed Nickel	28802820
Polished Gold Optic	28802990
AXOR FinishPlus*	28802XXX

Overhead showers 1 jet ceiling

Features of all variants

/ shower head size: 270 x 270 mm
 / spray type: Rain
 / material spray disc: metal

/ overhead shower removable for cleaning
 / installation: ceiling
 / connection type: basic set

/ suitable for continuous flow water heaters

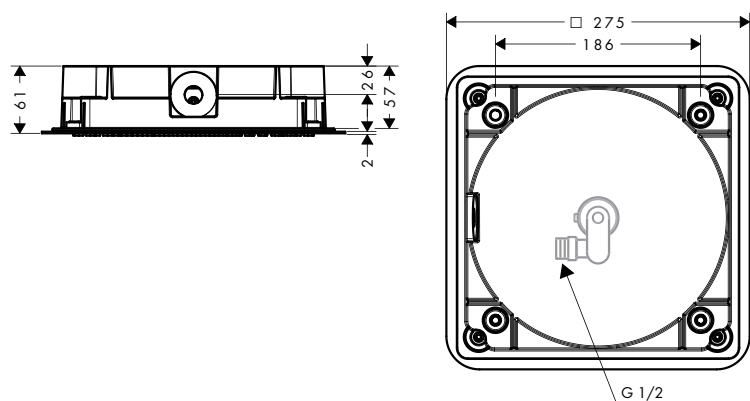
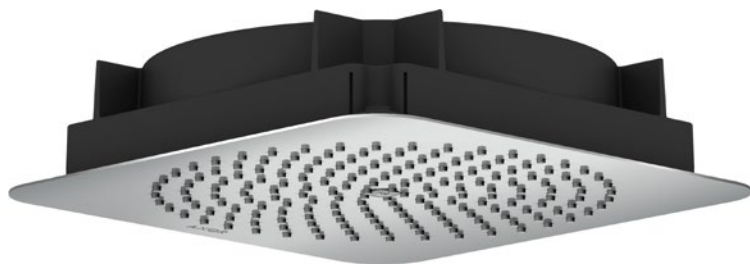

Sustainability



Technologies



Spray types



Overview variants

Shower head size	Number of sprays	Spray types	Max. flow rate at 3 bar (l/min)	Min. flow pressure (bar)	Finish	Available from	Code no.
270/270	1	Rain	6.8	1.2	Chrome	Q2/2024	28795000
					Brushed Bronze	Q2/2024	28795140
					Brushed Black Chrome	Q2/2024	28795340
					Matt Black	Q2/2024	28795670
					Brushed Nickel	Q2/2024	28795820
					Polished Gold Optic	Q2/2024	28795990
					AXOR FinishPlus*		28795XXX
					AXOR FinishPlus*		28795XXX
270/270	1	Rain	11.3	1	Chrome	Q2/2024	28794000
					Brushed Bronze	Q2/2024	28794140
					Brushed Black Chrome	Q2/2024	28794340
					Matt Black	Q2/2024	28794670
					Brushed Nickel	Q2/2024	28794820
					Polished Gold Optic	Q2/2024	28794990
					AXOR FinishPlus*		28794XXX
					AXOR FinishPlus*		28794XXX

 Required parts:

Basic set for overhead shower ceiling

Code no.

26039180

Basic set for overhead shower ceiling

Features

/ minimum mounting depth: 60 mm

/ maximum mounting depth: 80 mm

/ connection dimension: G 1/2

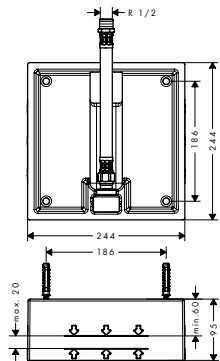

Available from	Code no.
Q2/2024	26039180

Wall escutcheon 120/120 softsquare

Features

/ material: metal
/ wall-mounted

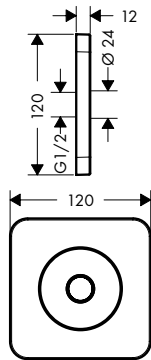

Finish	Available from	Code no.
Chrome	Q2/2024	28801000
Matt Black	Q2/2024	28801670
AXOR FinishPlus*		28801XXX

Optional parts:



Overhead shower 270/270 1jet EcoSmart+ with shower arm

Finish	Code no.
Chrome	28791000
Matt Black	28791670
AXOR FinishPlus*	28791XXX



Overhead shower 270/270 1jet with shower arm

Chrome	28790000
Matt Black	28790670
AXOR FinishPlus*	28790XXX

Ceiling escutcheon 120/120 softsquare

Features

/ material: metal
/ ceiling installation

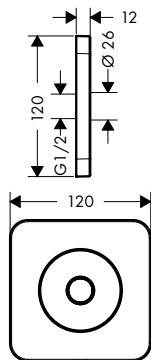

Finish	Available from	Code no.
Chrome	Q2/2024	28802000
Brushed Bronze	Q2/2024	28802140
Brushed Black Chrome	Q2/2024	28802340
Matt Black	Q2/2024	28802670
Brushed Nickel	Q2/2024	28802820
Polished Gold Optic	Q2/2024	28802990
AXOR FinishPlus*		28802XXX

Measurements within scale drawings are in mm. Technical specifications and units of measure are subject to change.

Ceiling escutcheon 120/120 softsquare

Optional parts:



Overhead shower 270/270 1jet EcoSmart+ with ceiling connector



Overhead shower 270/270 1jet with ceiling connector

Finish	Code no.
Chrome	28793000
Brushed Bronze	28793140
Brushed Black Chrome	28793340
Matt Black	28793670
Brushed Nickel	28793820
Polished Gold Optic	28793990
AXOR FinishPlus*	28793XXX
Chrome	28792000
Brushed Bronze	28792140
Brushed Black Chrome	28792340
Matt Black	28792670
Brushed Nickel	28792820
Polished Gold Optic	28792990
AXOR FinishPlus*	28792XXX

Porter unit 120/120 softsquare with baton hand shower 2jet and textile shower hose

Features

- / consists of: porter unit, baton hand shower, shower holder, shower hose
- / shower head size: 68 x 24 mm
- / integrated support function
- / spray type: Rain, Mono
- / maximum flow rate at 3 bar: 16,2 l/min
- / minimum flow pressure: 1 bar
- / operating pressure: min. 1 bar/max. 10 bar
- / for shower hoses with conical or cylindrical nut on both sides
- / with non-return valve
- / wall mounting: screw fastening
- / rinseable screen seal

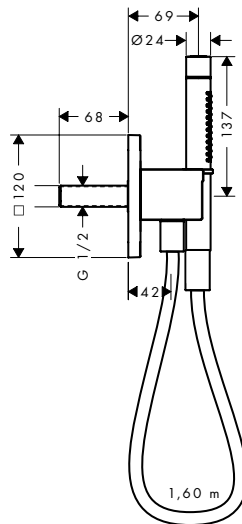

Technologies



Spray types



Finish	Available from	Code no.
Chrome	Q2/2024	49626000
Brushed Bronze	Q2/2024	49626140
Brushed Black Chrome	Q2/2024	49626340
Matt Black	Q2/2024	49626670
Brushed Nickel	Q2/2024	49626820
Polished Gold Optic	Q2/2024	49626990
AXOR FinishPlus*		49626XXX

*AXOR FinishPlus: For further AXOR FinishPlus surfaces please see the AXOR FinishPlus overview on page 27.

AXOR ShowerSelect ID





AXOR ShowerSelect ID

Precision meets Personality.

AXOR ShowerSelect ID brings unprecedented precision and personalization to the shower experience. Developed in collaboration with PHOENIX, the concealed thermostatic mixer extends just 45 mm from the wall, a feat made possible by the new AXOR iBox universal 2. Within these sleek confines, a central temperature control dial offers satisfying haptic and auditory feedback while surrounding paddles utilize the latest Select technology, allowing for quick, easy switching among spray types and outlets. With three design styles to choose from—round, square or softsquare—as well as a wide range of AXOR FinishPlus surfaces and AXOR Signature custom inlay options, AXOR ShowerSelect ID is more than a marvel of technology and design. As its name suggests, it's a unique opportunity to express one's individual identity, taste and style.

Design: PHOENIX

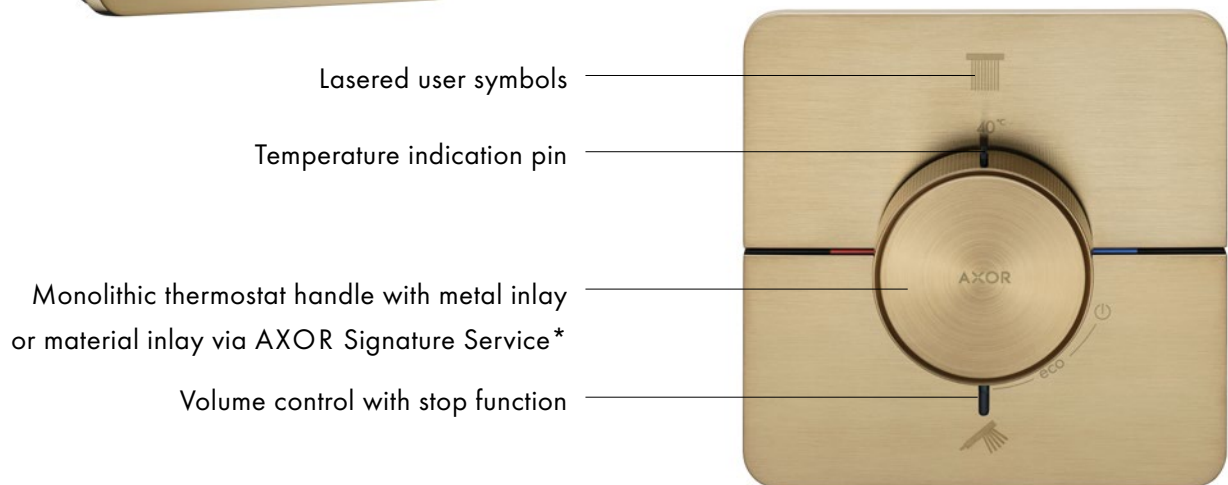
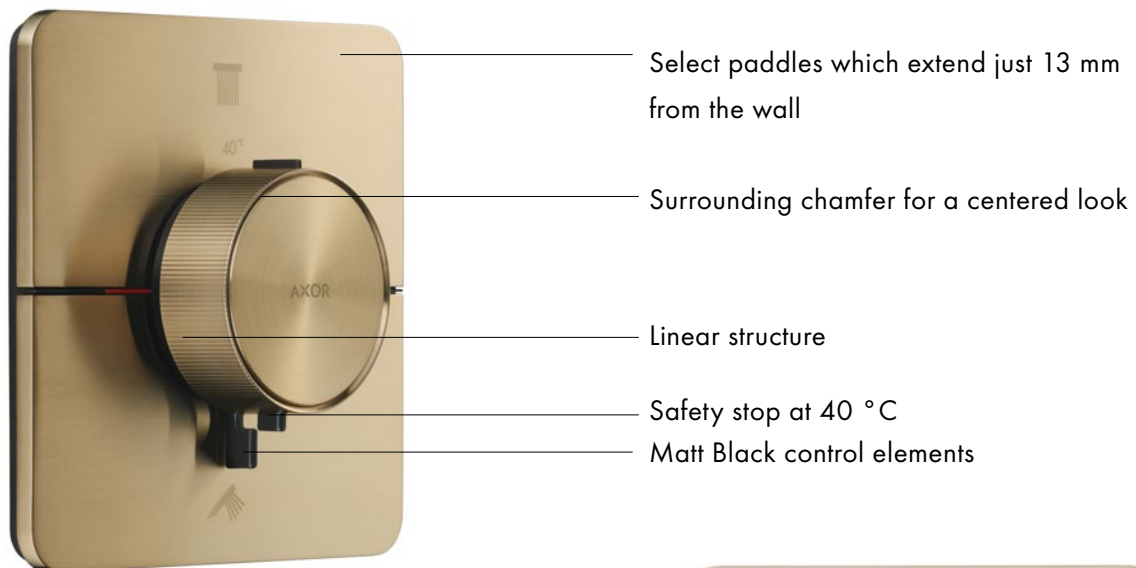

AXOR ShowerSelect ID is characterized by ultra-precise control, universal design styles and unique customization options. Users can combine AXOR ShowerSelect ID thermostats to cover up to four outlets in order to accommodate almost any shower configuration, from a small 1 outlet shower enclosure up to a 4 function wellness shower.

* Same finish inlay for AXOR FinishPlus surfaces, Matt Black inlay for Chrome surface

AXOR Finishes

Surface colors from stock*



Chrome
-000



Matt Black
-670



Matt White
-700
(only round)



Brushed Bronze
-140



Brushed Black Chrome
-340



Polished Gold Optic
-990

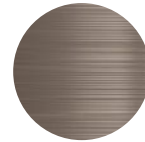

Brushed Nickel
-820

Surface colors with a production time of max. 6 weeks* (excl. transport)



Brushed Brass
-950



Brushed Gold Optic
-250



Polished Red Gold
-300



Brushed Red Gold
-310

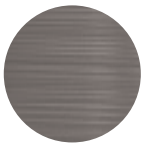

Stainless Steel Optic
-800



Polished Black Chrome
-330

*Please note that production times and stock availabilities are only valid for small quantities and may vary for project or bulk orders.

AXOR FinishPlus - the refinement of the unique

The exclusive surface finishes from AXOR FinishPlus set new standards, from the lacquered Matt Black surface to Polished Gold Optic and Brushed Black Chrome. Surfaces of exceptional brilliance, robustness, and durability, manufactured in Germany to the highest technical standards – from single pieces to large quantities. AXOR FinishPlus PVD surface finishes have character. Each color is the result of intensive development and refined in AXOR's vacuum chambers using the PVD (physical vapor deposition) process. An electric arc discharges in the high vacuum, gases combine with zirconium. The mixture hits the faucet's chrome surface. This high-tech process gives the surface unprecedented brilliance and high resistance to scratches, cleaning agents, and the salt of the sea air.



AXOR Signature Service – AXOR ShowerSelect ID

AXOR Signature is an exclusive service that takes a design object and makes it one-of-a-kind, whether by providing each mixer with the customer's personal touch or by modifying it to fit specific dimensions. The personal and customized result manufactured by AXOR experts in Schiltach. With the utmost in care and precise craftsmanship in accordance with industrial standards.

Bi-color

For those wishing to accentuate the minimalist shape and bold simplicity of AXOR ShowerSelect ID, the AXOR Signature Service introduces custom bi-color finishes. With 10 distinct PVD finishes to choose from, the combination options - from subtle tonal shifts to bold and colorful contrasts - are seemingly endless.

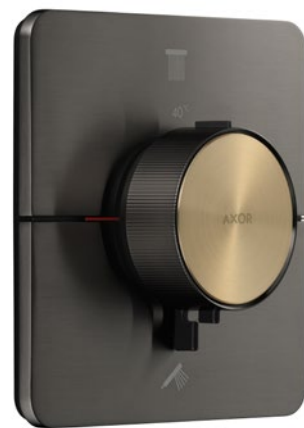

To request the customized Bi-color product via the AXOR Signature Service, the order consists of a detailed description of each product part and the desired finish.

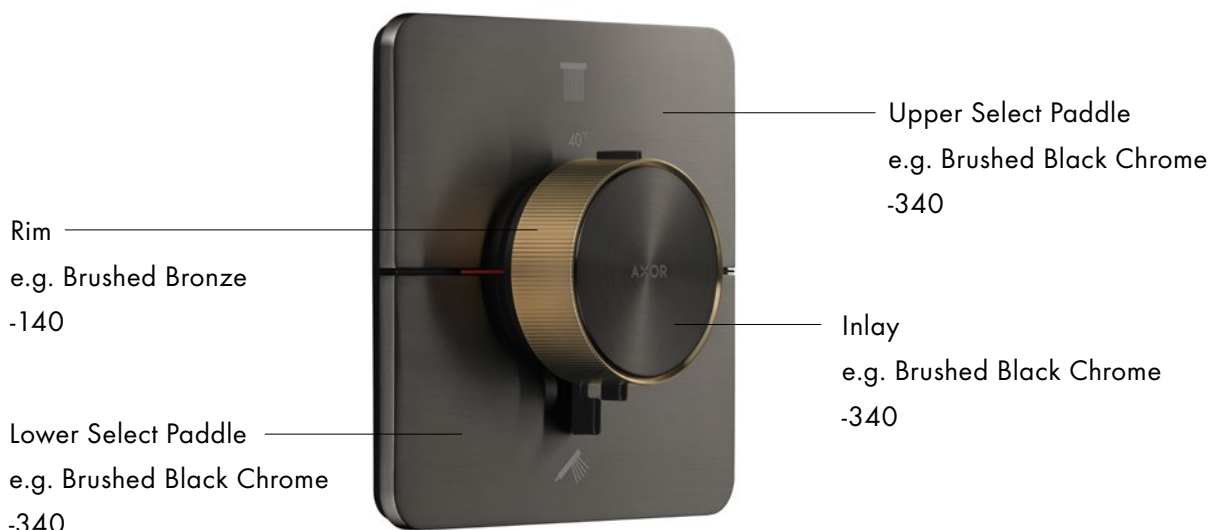

Individualization possibilities are also available for dummy products.

AXOR Signature Service – AXOR ShowerSelect ID

Material inlays

Beyond functionality and design, AXOR ShowerSelect ID also sets new standards in individualization. With its unique system of custom inlay options for the product's monolithic central dial, AXOR ShowerSelect ID presents the perfect canvas to express your personality. This includes black Nero Marquina marble, Marble Lasa Covelano Vena Oro, black walnut, mirrored glass and black glass.



Individualization possibilities are also available for dummy products.

To request the customized product via the AXOR Signature Service, the order number is composed of the model number, the finish and the individualization service, the S-Tag. This creates an individual product that fits into every bathroom interior.

Model: Selection of the AXOR ShowerSelect ID product

Square



Thermostat for concealed installation square for 2 functions e.g. # 36752XXX

Softsquare



Thermostat for concealed installation softsquare for 2 functions e.g. # 36754XXX

Round



Thermostat for concealed installation round for 2 functions e.g. # 36750XXX

Finish: Selection of the AXOR FinishPlus surface



Chrome
-000



Matt Black
-670



Matt White
-700
(only round)



Brushed Bronze
-140

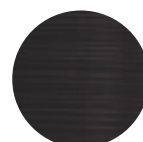

Brushed Black Chrome
-340



Polished Gold Optic
-990



Brushed Nickel
-820



Brushed Brass
-950



Brushed Gold Optic
-250



Polished Red Gold
-300

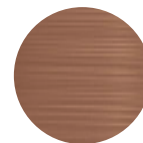

Brushed Red Gold
-310

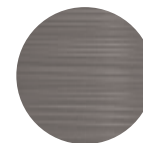

Stainless Steel Optic
-800



Polished Black Chrome
-330

S-Tag: Selection of material inlay



Mirror Glass
-MIG



Black Glass
-BLG



Black Walnut
-BLW



Marble Lasa
Covelano Vena Oro
-MLC



Marble Nero
Marquina
-MNM

Final ordering number



36754XXX



Model number

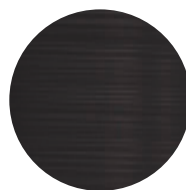

36754340



Finish



36754340 + BLW



S-Tag

Thermostats for concealed installation for 1 function

Features of all variants

- / 1 function
- / comfortable turning on / off of outlets with large Select-paddle
- / precise temperature control thanks to vertical handle structure and haptic feedback from the thermostat handle
- / water flow control with stop function
- / thermostat cartridge, Start/stop valve to operate the functions
- / maximum flow rate at 3 bar: 20,3 l/min
- / min. operating pressure: 1 bar
- / max. operating pressure: 10 bar
- / flat escutcheon for more space in the shower
- / escutcheon can be aligned by +/- 3°
- / easy installation due to pre-assembled function block
- / handles always at the same height regardless of the installation depth of the basic set
- / Safety stop at 40 °C
- / temperature limitation adjustable
- / the thermostat offers the possibility for thermal disinfection
- / material button: metal
- / material handles: metal
- / connection type: basic set iBox universal 2 (# 01400180)
- / Select-paddle is delivered with lasered On/Off symbol

round

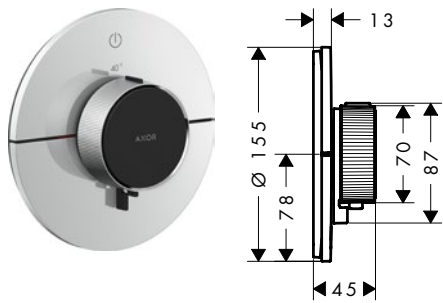

square

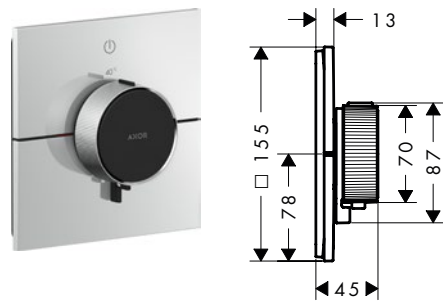

softsquare

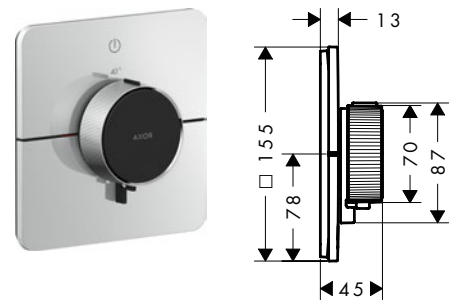

Sustainability



Technologies



Overview variants

Shape	Finish	Available from	Code no.	
round	Chrome	Q2/2024	36756000	
	Brushed Bronze	Q2/2024	36756140	
	Brushed Black Chrome	Q2/2024	36756340	
	Matt Black	Q2/2024	36756670	
	Matt White	Q2/2024	36756700	
	Brushed Nickel	Q2/2024	36756820	
	Polished Gold Optic	Q2/2024	36756990	
	AXOR FinishPlus*		36756XXX	
	square	Chrome	Q2/2024	36757000
Brushed Bronze		Q2/2024	36757140	
Brushed Black Chrome		Q2/2024	36757340	
Matt Black		Q2/2024	36757670	
Brushed Nickel		Q2/2024	36757820	
Polished Gold Optic		Q2/2024	36757990	
AXOR FinishPlus*			36757XXX	
softsquare		Chrome	Q2/2024	36758000
		Brushed Bronze	Q2/2024	36758140
	Brushed Black Chrome	Q2/2024	36758340	
	Matt Black	Q2/2024	36758670	
	Brushed Nickel	Q2/2024	36758820	
	Polished Gold Optic	Q2/2024	36758990	
	AXOR FinishPlus*		36758XXX	

Required parts:

AXOR iBox universal 2 Basic set	Code no. 01400180
---------------------------------	----------------------

Thermostats for concealed installation for 2 functions

Features of all variants

- / 2 functions
- / simultaneous use of several outlets
- / comfortable turning on / off of outlets with large Select-paddle
- / precise temperature control thanks to vertical handle structure and haptic feedback from the thermostat handle
- / water flow control with stop function
- / thermostat cartridge, Start/stop valve to operate the functions
- / maximum flow rate at 3 bar: 22,1 l/min
- / flow rate upper outlet: 20 l/min
- / flow rate lower outlet: 20 l/min
- / min. operating pressure: 1 bar
- / max. operating pressure: 10 bar
- / flat escutcheon for more space in the shower
- / escutcheon can be aligned by +/- 3°
- / easy installation due to pre-assembled function block
- / handles always at the same height regardless of the installation depth of the basic set
- / Safety stop at 40 °C
- / temperature limitation adjustable
- / the thermostat offers the possibility for thermal disinfection
- / material button: metal
- / material handles: metal
- / connection type: basic set iBox universal 2 (# 01400180)
- / Select-paddles are delivered with lasered user symbols (Rain large and hand shower)

round

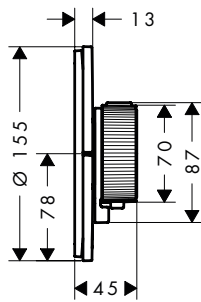

square

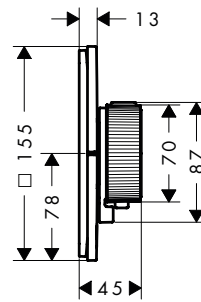

softsquare

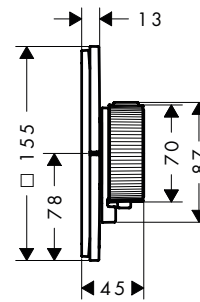

Sustainability



Technologies

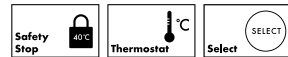

Overview variants

Shape	Finish	Available from	Code no.	
round	Chrome	Q2/2024	36750000	
	Brushed Bronze	Q2/2024	36750140	
	Brushed Black Chrome	Q2/2024	36750340	
	Matt Black	Q2/2024	36750670	
	Matt White	Q2/2024	36750700	
	Brushed Nickel	Q2/2024	36750820	
	Polished Gold Optic	Q2/2024	36750990	
	AXOR FinishPlus*		36750XXX	
	square	Chrome	Q2/2024	36752000
Brushed Bronze		Q2/2024	36752140	
Brushed Black Chrome		Q2/2024	36752340	
Matt Black		Q2/2024	36752670	
Brushed Nickel		Q2/2024	36752820	
Polished Gold Optic		Q2/2024	36752990	
AXOR FinishPlus*			36752XXX	
softsquare		Chrome	Q2/2024	36754000
		Brushed Bronze	Q2/2024	36754140
	Brushed Black Chrome	Q2/2024	36754340	
	Matt Black	Q2/2024	36754670	
	Brushed Nickel	Q2/2024	36754820	
	Polished Gold Optic	Q2/2024	36754990	
	AXOR FinishPlus*		36754XXX	

Required parts:



AXOR iBox universal 2 Basic set

Code no.

01400180

* AXOR FinishPlus: For further AXOR FinishPlus surfaces please see the AXOR FinishPlus overview on page 27.

Thermostat for concealed installation for 2 functions with integrated security combination according to EN1717

Features of all variants

- / 2 functions
- / comfortable turning on / off of outlets with large Select-paddle
- / precise temperature control thanks to vertical handle structure and haptic feedback from the thermostat handle
- / water flow control with stop function
- / thermostat cartridge, Start/stop valve to operate the functions
- / maximum flow rate at 3 bar: 26 l/min
- / flow rate upper outlet: 23 l/min
- / flow rate lower outlet: 23 l/min
- / min. operating pressure: 1 bar
- / max. operating pressure: 10 bar
- / flat escutcheon for more space in the shower
- / escutcheon can be aligned by +/- 3°
- / easy installation due to pre-assembled function block
- / handles always at the same height regardless of the installation depth of the basic set
- / Safety stop at 40 °C
- / temperature limitation adjustable
- / the thermostat offers the possibility for thermal disinfection
- / with integrated safety combination EN 1717
- / material button: metal
- / material handles: metal
- / connection type: basic set iBox universal 2 (# 01400180)
- / Select-paddles are delivered with lasered user symbols (hand shower and bath tub)

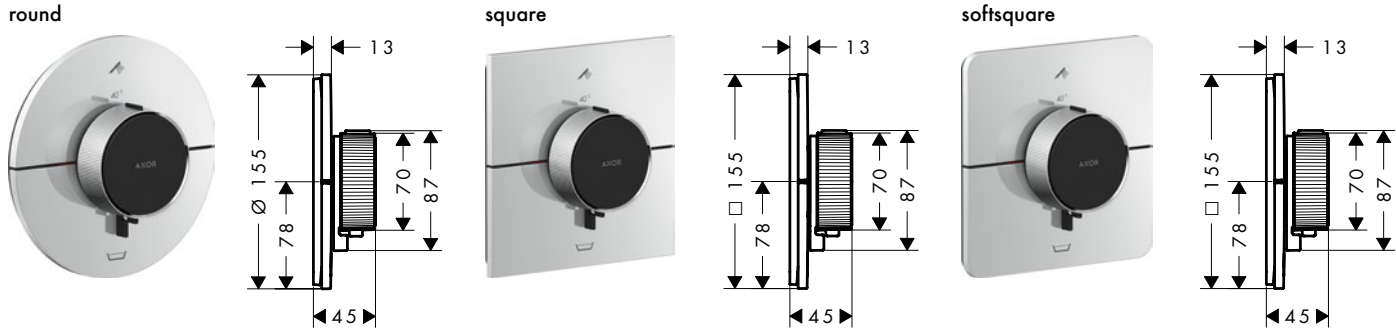

Sustainability



Technologies



Overview variants

Shape	Finish	Available from	Code no.	
round	Chrome	Q2/2024	36751000	
	Brushed Bronze	Q2/2024	36751140	
	Brushed Black Chrome	Q2/2024	36751340	
	Matt Black	Q2/2024	36751670	
	Matt White	Q2/2024	36751700	
	Brushed Nickel	Q2/2024	36751820	
	Polished Gold Optic	Q2/2024	36751990	
	AXOR FinishPlus*		36751XXX	
	square	Chrome	Q2/2024	36753000
		Brushed Bronze	Q2/2024	36753140
Brushed Black Chrome		Q2/2024	36753340	
Matt Black		Q2/2024	36753670	
Brushed Nickel		Q2/2024	36753820	
Polished Gold Optic		Q2/2024	36753990	
AXOR FinishPlus*			36753XXX	
softsquare		Chrome	Q2/2024	36755000
		Brushed Bronze	Q2/2024	36755140
		Brushed Black Chrome	Q2/2024	36755340
	Matt Black	Q2/2024	36755670	
	Brushed Nickel	Q2/2024	36755820	
	Polished Gold Optic	Q2/2024	36755990	
	AXOR FinishPlus*		36755XXX	

Required parts:	Code no.
AXOR iBox universal 2 Basic set	01400180

Thermostats HighFlow for concealed installation

Features of all variants

- / temperature and water flow control
- / precise temperature control thanks to vertical handle structure and haptic feedback from the thermostat handle
- / water flow control with stop function
- / thermostat cartridge
- / maximum flow rate at 3 bar: 24 l/min
- / flow rate upper outlet: 24 l/min

- / flow rate lower outlet: 23 l/min
- / min. operating pressure: 1 bar
- / max. operating pressure: 10 bar
- / flat escutcheon for more space in the shower
- / escutcheon can be aligned by +/- 3°
- / easy installation due to pre-assembled function block

- / handles always at the same height regardless of the installation depth of the basic set
- / Safety stop at 40 °C
- / temperature limitation adjustable
- / material button: metal
- / material handles: metal
- / connection type: basic set iBox universal 2 (# 01400180)

round

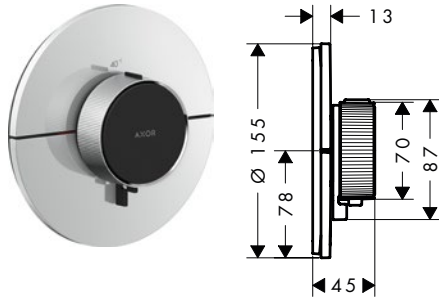

square

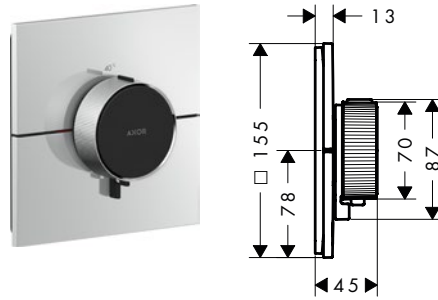

softsquare

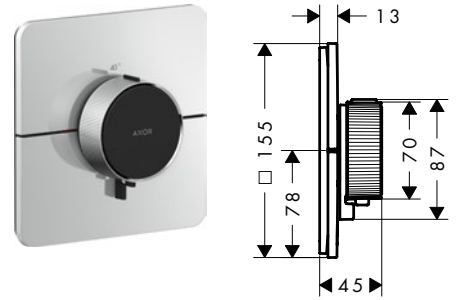

Sustainability



Technologies



Overview variants

Shape	Finish	Available from	Code no.	
round	Chrome	Q2/2024	36759000	
	Brushed Bronze	Q2/2024	36759140	
	Brushed Black Chrome	Q2/2024	36759340	
	Matt Black	Q2/2024	36759670	
	Matt White	Q2/2024	36759700	
	Brushed Nickel	Q2/2024	36759820	
	Polished Gold Optic	Q2/2024	36759990	
	AXOR FinishPlus*		36759XXX	
	square	Chrome	Q2/2024	36774000
		Brushed Bronze	Q2/2024	36774140
Brushed Black Chrome		Q2/2024	36774340	
Matt Black		Q2/2024	36774670	
Brushed Nickel		Q2/2024	36774820	
Polished Gold Optic		Q2/2024	36774990	
AXOR FinishPlus*			36774XXX	
softsquare		Chrome	Q2/2024	36775000
		Brushed Bronze	Q2/2024	36775140
		Brushed Black Chrome	Q2/2024	36775340
	Matt Black	Q2/2024	36775670	
	Brushed Nickel	Q2/2024	36775820	
	Polished Gold Optic	Q2/2024	36775990	
	AXOR FinishPlus*		36775XXX	

Required parts:



AXOR iBox universal 2 Basic set

Code no.
01400180

*AXOR FinishPlus: For further AXOR FinishPlus surfaces please see the AXOR FinishPlus overview on page 27.

Thermostat HighFlow for concealed installation for 1 function and additional outlet

Features of all variants

- / 1 function and 1 additional outlet
- / Select push-button on/off control for 1 outlet
- / precise temperature control thanks to vertical handle structure and haptic feedback from the thermostat handle
- / water flow control with stop function
- / thermostat cartridge, Start/stop valve to operate the functions
- / maximum flow rate at 3 bar: 32,8 l/min
- / flow rate upper outlet: 23 l/min
- / flow rate lower outlet: 23 l/min
- / min. operating pressure: 1 bar
- / max. operating pressure: 10 bar
- / flat escutcheon for more space in the shower
- / escutcheon can be aligned by +/- 3°
- / easy installation due to pre-assembled function block
- / handles always at the same height regardless of the installation depth of the basic set
- / Safety stop at 40 °C
- / temperature limitation adjustable
- / the thermostat offers the possibility for thermal disinfection
- / material button: metal
- / material handles: metal
- / connection type: basic set iBox universal 2 (# 01400180)
- / thermostat is delivered with buttons hand shower, bath tub, whirl, body shower and On/Off

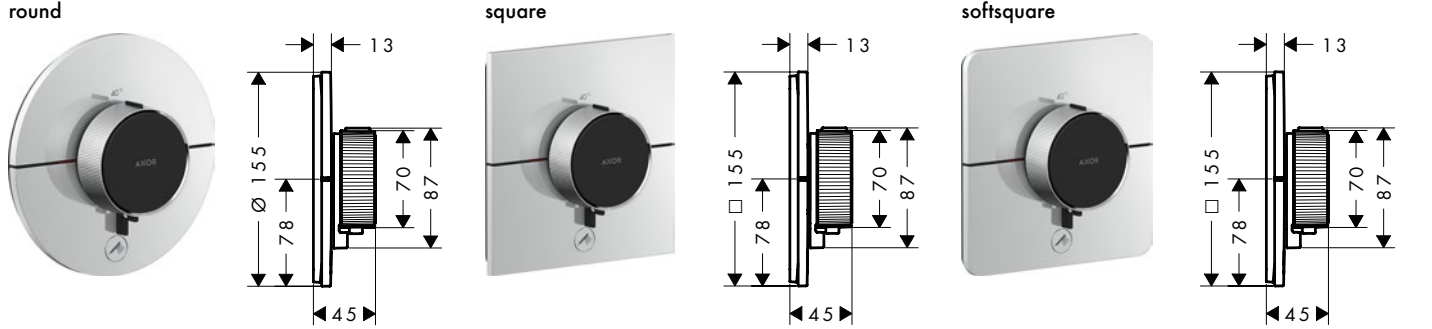

Sustainability



Technologies



Overview variants

Shape	Finish	Available from	Code no.	
round	Chrome	Q2/2024	36776000	
	Brushed Bronze	Q2/2024	36776140	
	Brushed Black Chrome	Q2/2024	36776340	
	Matt Black	Q2/2024	36776670	
	Matt White	Q2/2024	36776700	
	Brushed Nickel	Q2/2024	36776820	
	Polished Gold Optic	Q2/2024	36776990	
	AXOR FinishPlus*		36776XXX	
	square	Chrome	Q2/2024	36777000
Brushed Bronze		Q2/2024	36777140	
Brushed Black Chrome		Q2/2024	36777340	
Matt Black		Q2/2024	36777670	
Brushed Nickel		Q2/2024	36777820	
Polished Gold Optic		Q2/2024	36777990	
AXOR FinishPlus*			36777XXX	
softsquare		Chrome	Q2/2024	36778000
		Brushed Bronze	Q2/2024	36778140
	Brushed Black Chrome	Q2/2024	36778340	
	Matt Black	Q2/2024	36778670	
	Brushed Nickel	Q2/2024	36778820	
	Polished Gold Optic	Q2/2024	36778990	
	AXOR FinishPlus*		36778XXX	

Required parts:	Code no.
AXOR iBox universal 2 Basic set	01400180

Valves for concealed installation

Features of all variants

- / 3 functions
- / simultaneous use of several outlets
- / comfortable turning on / off of outlets with large Select-paddle
- / Start/stop valve to operate the functions
- / maximum flow rate at 3 bar: 32 l/min
- / flow rate upper outlet: 26 l/min

- / Flow rate left and right: 26 l/min
- / min. operating pressure: 1 bar
- / max. operating pressure: 10 bar
- / flat escutcheon for more space in the shower
- / escutcheon can be aligned by +/- 3°
- / easy installation due to pre-assembled function block

- / material button: metal
- / connection type: basic set iBox universal 2 (# 01400180)
- / valve is delivered with buttons Rain small, Rain large, hand sower, Waterfall and Mono

round

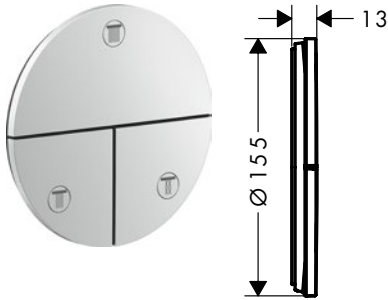

square

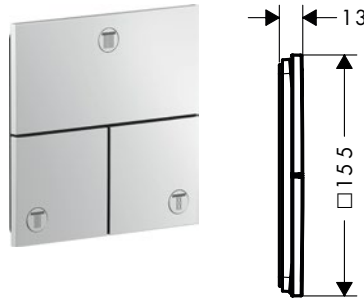

softsquare

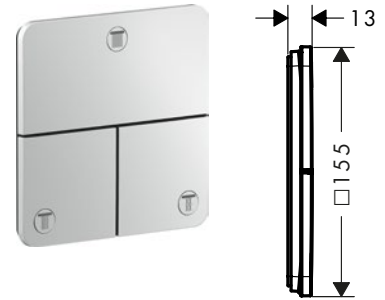

Technologies



Overview variants

Shape	Finish	Available from	Code no.
round	Chrome	Q2/2024	36779000
	Brushed Bronze	Q2/2024	36779140
	Brushed Black Chrome	Q2/2024	36779340
	Matt Black	Q2/2024	36779670
	Matt White	Q2/2024	36779700
	Brushed Nickel	Q2/2024	36779820
	Polished Gold Optic	Q2/2024	36779990
	AXOR FinishPlus*		36779XXX
square	Chrome	Q2/2024	36780000
	Brushed Bronze	Q2/2024	36780140
	Brushed Black Chrome	Q2/2024	36780340
	Matt Black	Q2/2024	36780670
	Brushed Nickel	Q2/2024	36780820
	Polished Gold Optic	Q2/2024	36780990
	AXOR FinishPlus*		36780XXX
	softsquare	Chrome	Q2/2024
Brushed Bronze		Q2/2024	36781140
Brushed Black Chrome		Q2/2024	36781340
Matt Black		Q2/2024	36781670
Brushed Nickel		Q2/2024	36781820
Polished Gold Optic		Q2/2024	36781990
AXOR FinishPlus*			36781XXX

 Required parts:

AXOR iBox universal 2 Basic set

Code no.

01400180

Extension element 5 mm

Features of all variants

/ for installation between tiles and finish set
 / is required if the basic set is installed too flat

/ for larger tile coverage
 / suitable for AXOR ShowerSelect ID

/ dimension: 170 x 170 mm
 / extension length: 5 mm

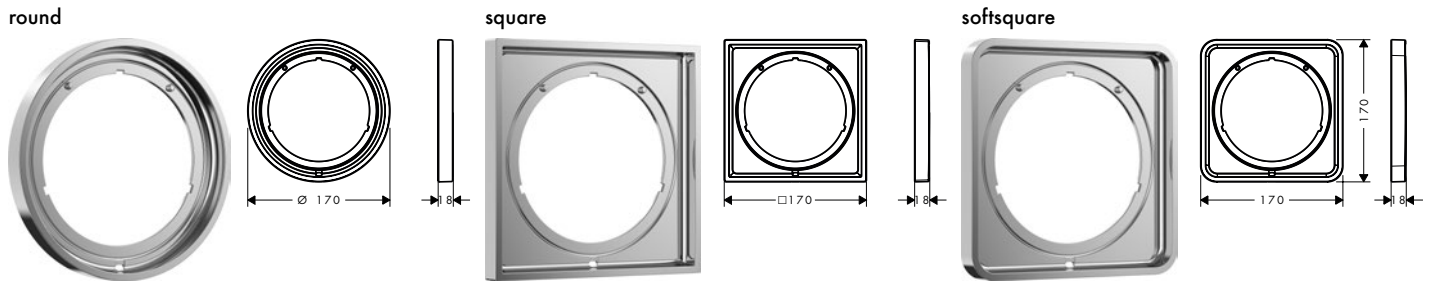

Overview variants

Shape	Finish	Available from	Code no.
round	Chrome	Q2/2024	13642000
	Brushed Bronze	Q2/2024	13642140
	Brushed Black Chrome	Q2/2024	13642340
	Matt Black	Q2/2024	13642670
	Matt White	Q2/2024	13642700
	Polished Gold Optic	Q2/2024	13642990
	AXOR FinishPlus*		13642XXX
square	Chrome	Q2/2024	13641000
	Brushed Bronze	Q2/2024	13641140
	Brushed Black Chrome	Q2/2024	13641340
	Matt Black	Q2/2024	13641670
	Polished Gold Optic	Q2/2024	13641990
	AXOR FinishPlus*		13641XXX
	softsquare	Chrome	Q2/2024
Brushed Bronze		Q2/2024	13640140
Brushed Black Chrome		Q2/2024	13640340
Matt Black		Q2/2024	13640670
Polished Gold Optic		Q2/2024	13640990
AXOR FinishPlus*			13640XXX

Extension element 22 mm

Features of all variants

/ for installation between tiles and finish set
/ is required if the basic set is installed too flat

/ for larger tile coverage
/ suitable for AXOR ShowerSelect ID

/ dimension: 170 x 170 mm
/ extension length: 22 mm

round

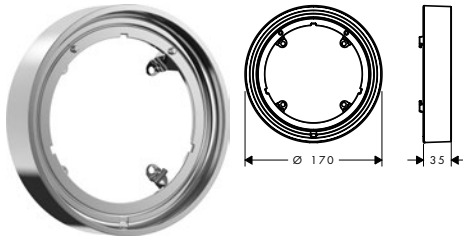

square

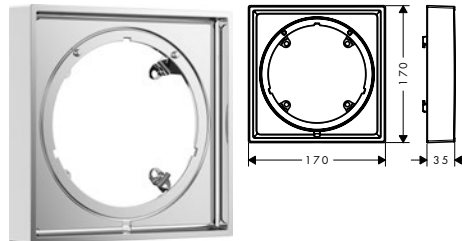

softsquare

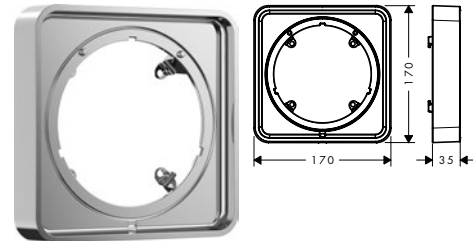

Overview variants

Shape	Finish	Available from	Code no.
round	Chrome	Q2/2024	13646000
	Brushed Bronze	Q2/2024	13646140
	Brushed Black Chrome	Q2/2024	13646340
	Matt Black	Q2/2024	13646670
	Matt White	Q2/2024	13646700
	Polished Gold Optic	Q2/2024	13646990
	AXOR FinishPlus*		13646XXX
square	Chrome	Q2/2024	13645000
	Brushed Bronze	Q2/2024	13645140
	Brushed Black Chrome	Q2/2024	13645340
	Matt Black	Q2/2024	13645670
	Polished Gold Optic	Q2/2024	13645990
	AXOR FinishPlus*		13645XXX
	softsquare	Chrome	Q2/2024
Brushed Bronze		Q2/2024	13643140
Brushed Black Chrome		Q2/2024	13643340
Matt Black		Q2/2024	13643670
Polished Gold Optic		Q2/2024	13643990
AXOR FinishPlus*			13643XXX

*AXOR FinishPlus: For further AXOR FinishPlus surfaces please see the AXOR FinishPlus overview on page 27.

AXOR iBox universal 2



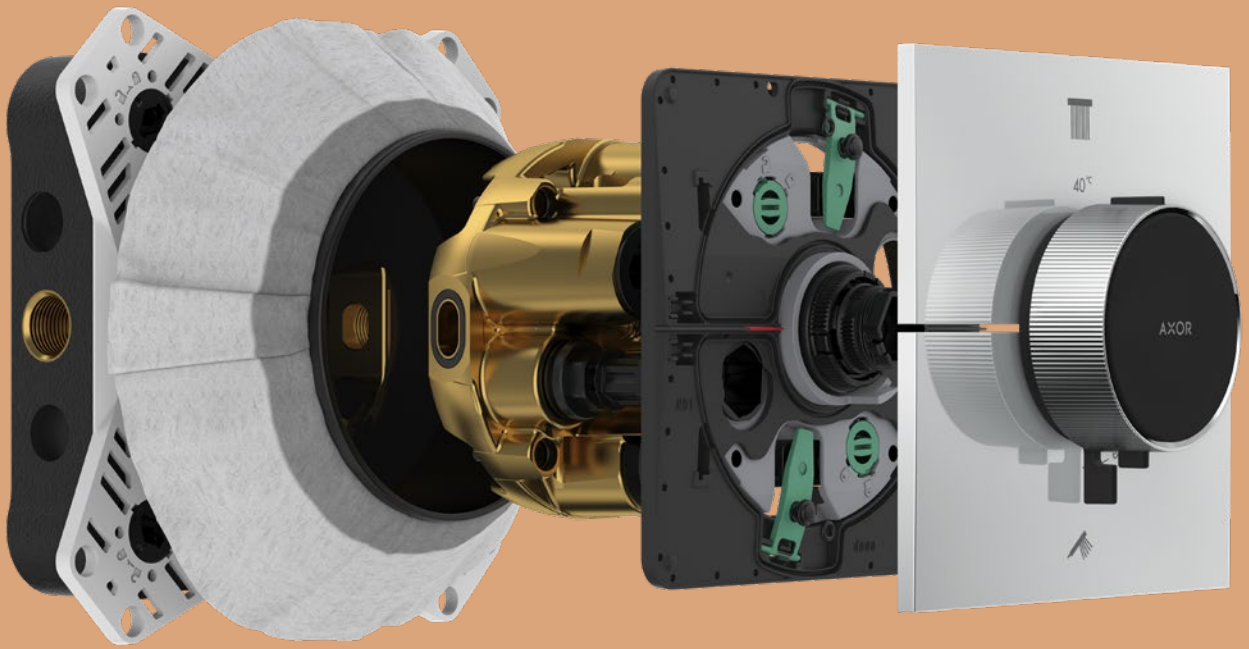

AXOR iBox universal 2

Powering the sleek design of AXOR ShowerSelect ID is none other than the new AXOR iBox universal 2. A revolutionary basic set for concealed installation that's even faster, smarter and more flexible than its celebrated predecessor introduced 22 years prior, AXOR iBox universal 2 represents the future of concealed-installed AXOR products. By its streamlined, modular design, this basic set enables unprecedentedly slimmer escutcheons while making increasingly complex, cutting-edge product arrangements both more powerful in function and easier to install than ever before. Simply put, the promise of AXOR iBox universal 2 lies in its name—one universal solution for a vast variety of concealed AXOR thermostats, to meet the exacting demands of both today's and tomorrow's bathrooms. The new AXOR iBox universal 2 can also be combined with all previous and future AXOR finish sets. Finish sets of existing collections only require an adapter plate for installation.



AXOR iBox universal 2 | Basic set

Basic set

Features

- / suitable for all new shower, bath tub and thermostat finish sets for concealed installation (AXOR ShowerSelect ID)
- / in conjunction with adapter plate (# 13588000) compatible with other concealed shower, bath tub and thermostat finish sets
- / material: dezincification brass, EPP foam, heat and sound insulating
- / connection thread Rp 1/2
- / connection dimension: DN15
- / no additional maintenance opening required
- / rotationally-symmetric installation
- / sound-decoupled installation
- / flexible mounting ring for different mounting situations
- / mounting ring adjustable in 5 mm steps
- / mounting ring suitable for front and rear installation
- / no shortening necessary thanks to sliding sleeve
- / support aid for the spirit level
- / integrated spirit level for correct horizontal and vertical alignment
- / sealing foil permanently fixed
- / minimum mounting depth: 80 mm
- / maximum mounting depth: 108 mm

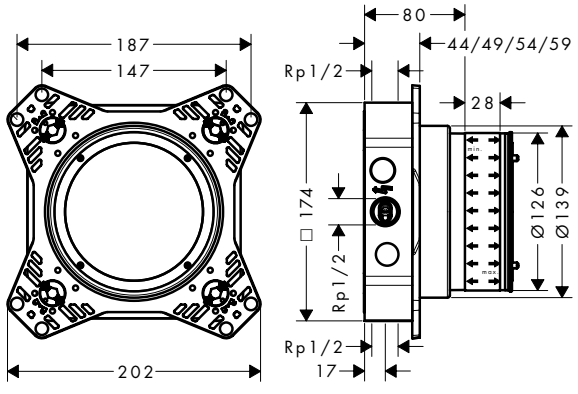

Technologies



Installation



Available from	Code no.
Q2/2024	01400180

Optional parts:

	Adapter plate for iBox universal 2	Code no. 13588000
	Extension iBox universal 2 basic set 25 mm	13637000
	Extension finish sets 25 - 75 mm	13632000
	Extension finish sets 25 mm	13638000

Adapter plate for iBox universal 2

Features

/ is required when installing iBox universal (# 01800180, # 01700180) compatible overhead showers, shower, bath tub and thermostat finish sets for concealed installation in conjunction with the iBox universal 2 (# 01500180, # 01400180)



Code no.
13588000

Extension finish sets 25 mm

Features

/ extension for finish sets ShowerSelect Comfort, DuoTurn and AXOR ShowerSelect ID

/ is required if the basic set is installed too deep
/ extension length: 25 mm



Code no.

13638000

Extension finish sets 25 - 75 mm

Features

/ extension for finish sets ShowerSelect Comfort, DuoTurn and AXOR ShowerSelect ID

/ is required if the basic set is installed too deep
/ extension length: 25 - 75 mm



Code no.

13632000

Extension iBox universal 2 basic set 25 mm

Features

/ extension for basic set

/ is required if the basic set is installed too deep

/ extension length: 25 mm



Code no.

13637000

AXOR

Hansgrohe Pte Ltd
69 Mohamed Sultan Road
Singapore 239015
info@hansgrohe.com.sg

AXOR-DESIGN.COM