



1	Introduction
10	Hansgrohe Trims and Installations
40	Axor Trims and Installations
62	Technical Information

iBox Universal Plus Rough: One for All

Since its introduction, the iBox Universal Plus rough has been the solution for numerous Hansgrohe and Axor concealed shower installations.

Its features are as varied as the number of possible uses. This revolutionary rough gives you more space, freedom of movement, and

planning freedom in the bathroom – and is easy and straightforward to install. So, it's no wonder that it has become an industry favorite.

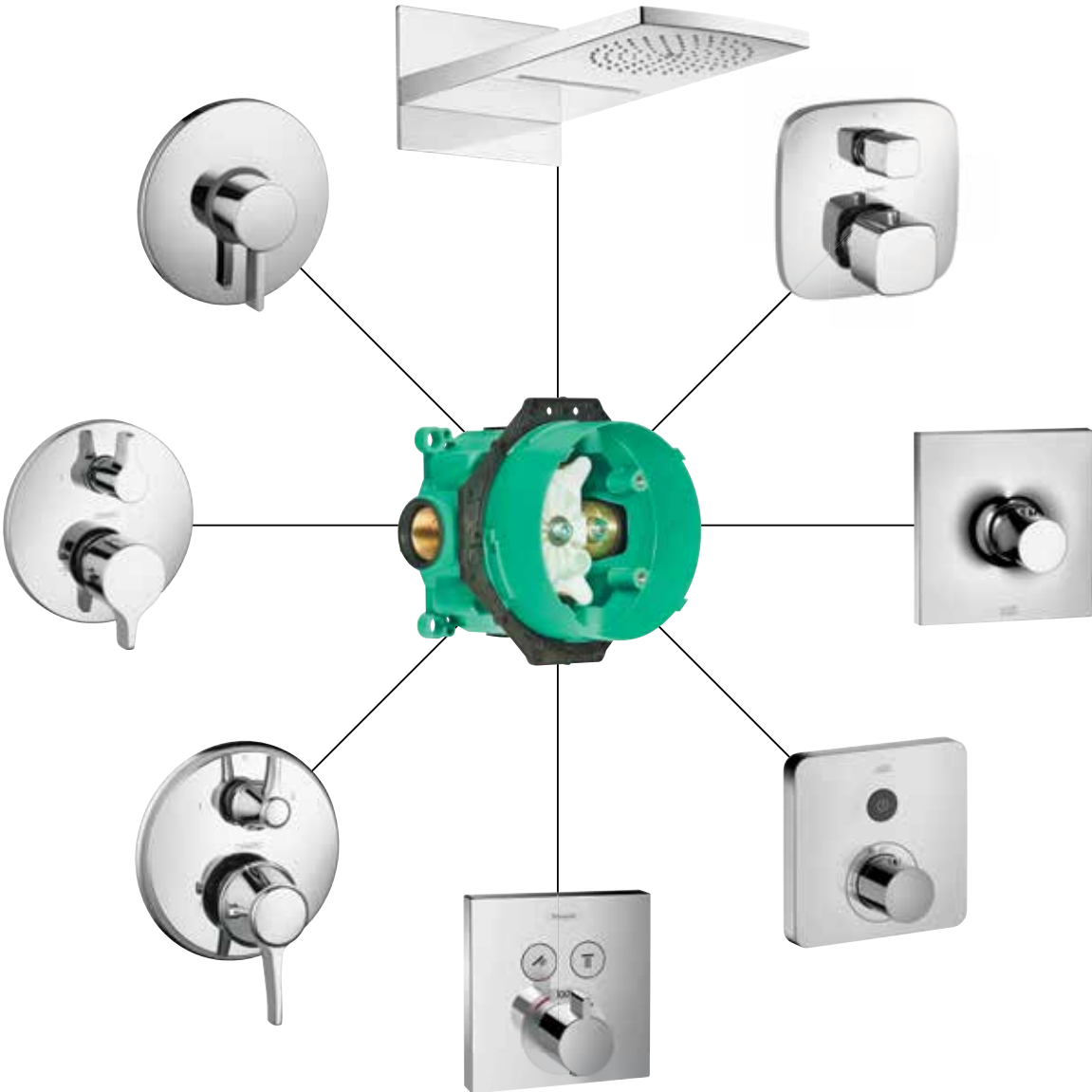

Wholesalers/Distributors

Eliminates the need for a multitude of roughs, streamlining ordering, warehousing and distribution, and reducing inventory costs.



**General Contractors/
Professional
Remodelers**

Allows construction to begin, even if final trim decisions have not been made yet, resulting in scheduling flexibility.



Plumber Installation

Standardizes and streamlines the installation process for projects large and small, allowing faster and easier installation than ever before.

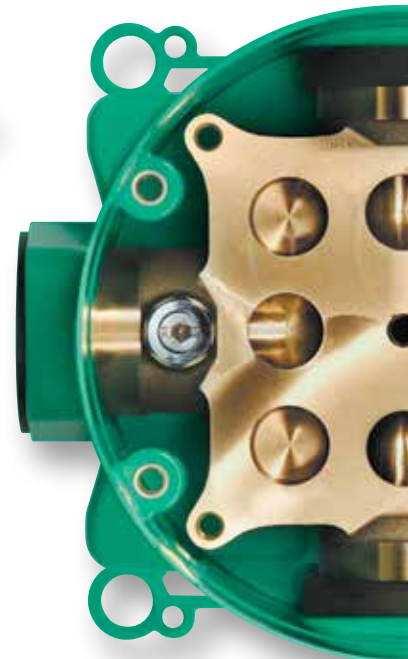

**iBox Universal Plus Rough: One for All
Plumbers and Distributors, Architects and Designers**

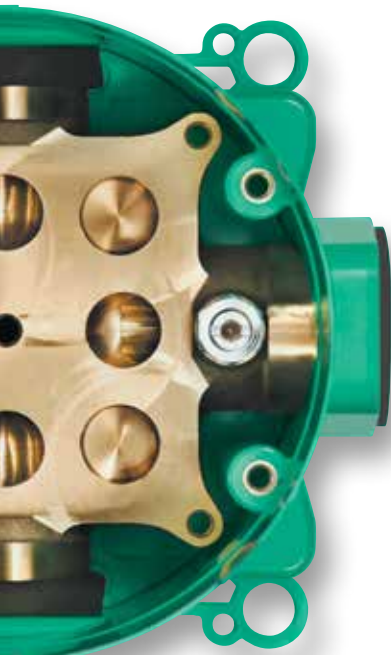

Architects

Ultimate compatibility and flexibility with respect to wall construction means streamlined room planning with a wealth of design options.

Designers

Aside from the obvious benefit of the wide variety of trim styles available, additional plumbing resulting from last minute design changes can often be avoided.

Plumber Servicing

With the built-in service stops, servicing the rough is made simple and efficient, especially in hospitality applications.

One rough to stock. One rough to order. One rough to install. One rough to service. The iBox Universal Plus rough creates synergy among all members of the distribution channel,

from manufacturer to end user. Eliminating the need for a multitude of roughs, the iBox Universal Plus rough brings increased efficiency to your business, whether you are an

architect or a plumber, a wholesaler or a remodeler. The iBox Universal Plus rough is your go-to for any shower installation.

**Easy to Sell, Easy to Install, Easy to Service:
What Professionals are Saying About The
iBox Universal Plus Rough**

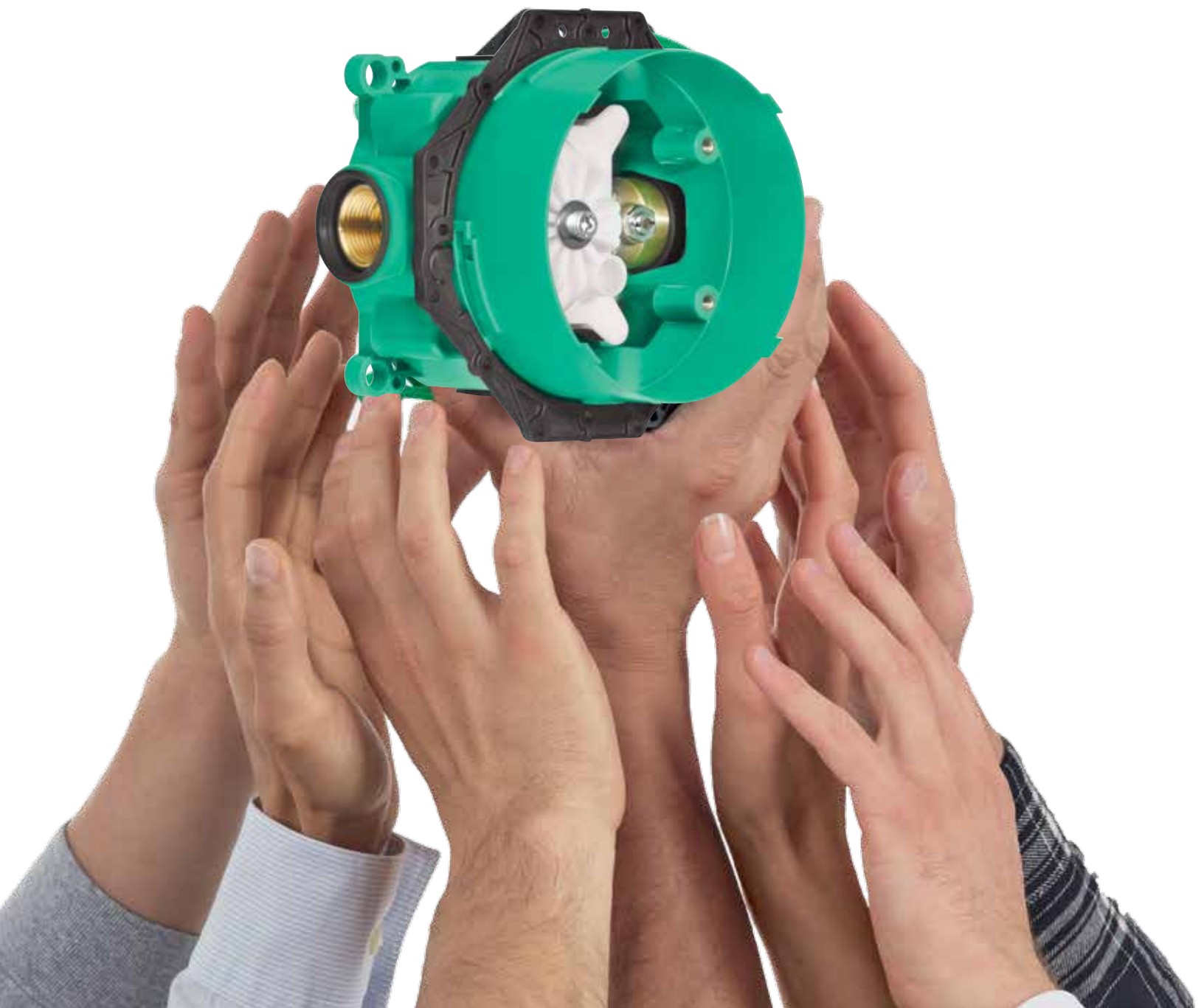

"IT HAS BEEN A SOLUTION FOR MOST OF MY CUSTOMER'S SHOWER LAYOUTS FOR EASE OF USE AND UNDERSTANDING."
—DESIREE G, SHOWROOM ASSOCIATE
"IT IS SUCH A GOOD QUALITY PRODUCT. ALL OF MY PLUMBERS AND CONTRACTORS LOVE IT TO INSTALL. THIS PRODUCT IS VERY EASY TO SELL. THE COLLECTIONS AND UNIVERSAL VALVE/TRIM SELECTION MAKE IT A BREEZE FOR LOOKUPS."

—GARY N, DISTRIBUTOR

"IT IS THE PERFECT VALVE. NOT ONLY CAN IT RUN OFF A 3/4" OR 1/2" PIPE, BUT THE QUALITY AND EASE IS SECOND TO NONE. MAKES IT EASY FOR ME AS A SALESMAN TO EXPLAIN TO CUSTOMERS AND EASIER FOR A PLUMBER TO INSTALL. A WONDERFUL BRAND AND WONDERFUL PRODUCT."

—MIKE S, SHOWROOM ASSOCIATE
"I LOVE TO SELL IT BECAUSE IF MY CUSTOMER WANTS TO DO A BATHROOM FACELIFT NEXT YEAR WE CAN PICK ANY OF YOUR TRIMS, IT WILL ALWAYS WORK, WITHOUT BREAKING THE BANK!" —KRISTINE S, SHOWROOM ASSOCIATE
"IT'S SO EASY TO FIND TECHNICAL INFORMATION THAT I CAN USE

TO HELP OUT INSTALLERS. IT GIVES ME MORE CONFIDENCE IN SELLING. NOT TO MENTION HOW EASY IT IS TO EXPLAIN THE BENEFITS"
—LISA W, SHOWROOM ASSOCIATE
"I LOVE IT BECAUSE IT IS SO EASY TO SELL AND HAS GREAT FUNCTIONS" —PHILANA L, PLUMBER
"IT IS THE PERFECT TWO-OUTLET SHOWER SOLUTION THAT A CUSTOMER CAN CONTROL WITH ONE TRIM.

I CAN SELL IT WITH PEACE OF MIND IN ANY JOB SCENARIO AND WITH ANY WATER LINE NEEDS. IT'S VERY CONVENIENT."

—CAROLINE S, SHOWROOM ASSOCIATE
"I HAVE BEEN SELLING THE iBOX UNIVERSAL PLUS ROUGH FOR OVER FIVE YEARS NOW.

I FIND IT TO BE AN EASY SELL DUE TO THE FACT THAT IT IS TRULY UNIVERSAL: THE iBOX

UNIVERSAL PLUS ROUGH IS USED FOR BOTH PRESSURE BALANCE AND THERMOSTATIC TRIMS. IT IS EASY TO EXPLAIN TO THE HOMEOWNER AND CONTRACTOR." —MINDI K, SHOWROOM ASSOCIATE
"IT IS FOOLPROOF AND THE TRIMS OFFER SAFETY FEATURES SUCH AS THE TEMPERATURE STOP THAT EASE THE MINDS OF EVERYONE." —TYRONE M, PLUMBER



iBox: Proven Successfully in the Field and Continuously Refined Since 2001

The success of the iBox Universal Plus rough mirrors the prior success of the iBox Universal which was launched in Germany in 2001.

Backed by years of proven results in the field, combined with ongoing research and development by our German engineers, the iBox Universal

Plus rough guarantees versatility, reliability, and ease of installation for your next shower installation.



Adjustable Installation Flange

Allows precise installation to fit two different depths, resulting in maximum versatility – mount to walls made of any building material and of any thickness. For pre-fabricated housing, the iBox Universal Plus rough can easily be pushed through the wall from behind and then mounted in place.

Versatile Installation

Installs easily in a standard 2" x 4" wall construction, as well as many special applications.

Revolutionary Technology that is Taking the Plumbing Industry by Storm

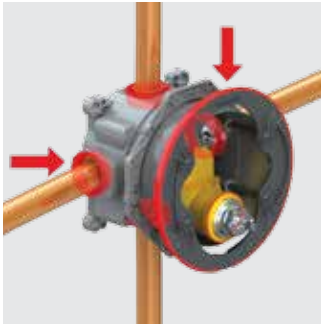

Water-Tight Seals All Around

Rubber seals on the housing and carrier plate create a water-tight installation. Any potential leaks drain into the shower compartment, not into the wall.

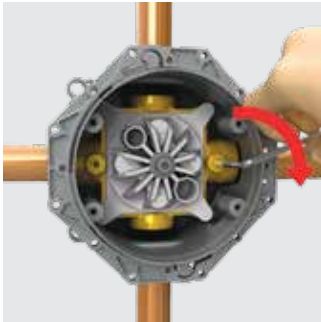

Built-In Service Stops

Allows easy servicing of the valve and other components.

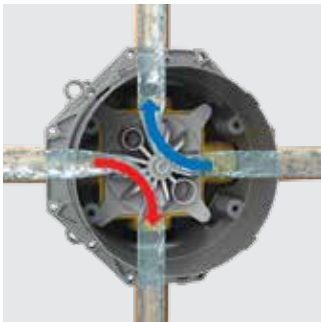

Simplified Pipe Flushing

The rough can easily be flushed prior to installing the function block. Hot and cold water remain isolated while passing through the flushing insert.

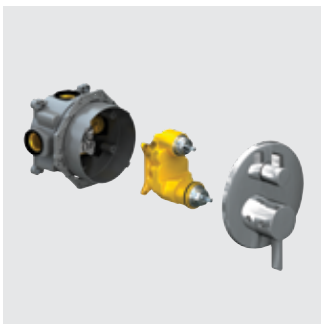

Trim Includes Function Block

Function block is supplied with trim, not the rough, allowing trim to be ordered later in the process, which may reduce warehousing, theft, and damage due to dirt or frost during the building phase.



Reduced Noise Transfer

The brass function block rests on rubber seals, so pipe vibrations transferred to the wall will be reduced. The trim carrier plate attaches to the housing, not the function block, minimizing noise transfer to the finished wall.

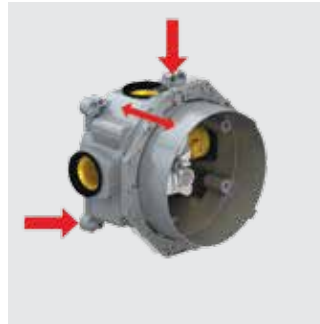

Multiple Mounting Options

Multiple mounting points and depth options allow the rough to be installed with any commonly used mounting system.



180° Rotational Symmetry

Even if the rough is installed upside down, the trim can still be mounted to the rough, avoiding costly repairs.

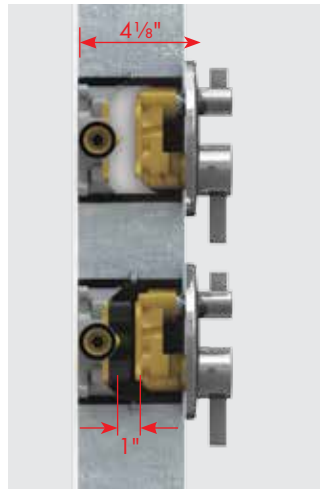

Extension Set

Even if the rough has been mounted too deeply into the wall, the problem is easily solved with an extension set. The extension set (sold separately) ensures a water-tight seal, keeping the walls free from dampness.



Shallow Extension Set

Limited installation depths are not a problem, thanks to the shallow extension set. Simply installing the set between the tiles and trim allows for installation in walls as shallow as 2 1/4".

Installation at-a-glance: iBox Universal Plus Rough



iBox Universal Plus Package Contents

Rough, installation flange, 1 plug, wall gasket, flushing insert, protective cap, and assembly instructions.



Create Connection Fittings

When using copper pipes, connection fittings should be created prior to installation.



Install Connection Fittings

Clamp the rough in a vice using a $\frac{3}{4}$ " nipple threaded into the top or bottom outlet, then install connection



Level Mounting

Mount the rough in exactly the right position using the integrated leveling points.



Connect Water Supply

Solder the water supply pipes and other risers to the previously installed fittings. Note: Please maintain a minimum 4" distance from the housing while soldering.



Valve Flushing

Simply turn on the water supply to flush the valve. The water passes through the flushing insert, which comes pre-installed.



Shut Off Water

After flushing, shut off water using built-in service stops, operated by an Allen wrench or flathead screwdriver. Replace protective cap.



Cut a Hole in the Wall

Trim a 5" diameter hole in the wall material to accommodate the rough.



Wall Gasket

Prevents water from entering the wall around the edge of the housing. Mount wall gasket onto the rough between two coats of adhesive.

Standard Trim Installation



Trim Package Contents

Escutcheon, carrier plate, function block, support housings, mounting screws, handles, handle adaptors, and assembly instructions.



Remove Excess Plaster Shield

Cut the excess plaster shield until it protrudes approximately 1/8" beyond the finished wall.



Seal With Silicone

To prevent moisture from entering the wall, seal the joint between the rough and the finished wall with silicone.



Remove Flushing Insert

Remove protective cap, then remove flushing insert by removing Allen screw. Remember to shut off the water if necessary using the service stops!



Install Function Block

Using the four mounting screws provided, install the function block on the rough. Re-open service stops to turn on water supply.



Install Carrier Plate

Use the included plastic screws to attach the carrier plate to the rough housing, preventing noise transfer and water leaks.



Install the Escutcheon

Simply fit escutcheon over the carrier plate – no screws or bolts needed. Rubber seal and O-rings on cartridges guarantee a firm hold.



Install the Handles

Finally, attach handles with the included set screws.



Completed Shower



Installation Video

For more information, scan for a video on the iBox Universal Plus rough.

iBox Universal Plus: The Perfect Foundation for ShowerSelect

With ShowerSelect trims, Hansgrohe has done it once again. Creating the perfect shower installation has never been so easy. Geometric design and revolutionary

push-button control are combined into a sleek package. A simple touch of a button is all it takes to switch functions on and off, or to change the spray modes. Everything works

purely mechanically, providing long-lasting reliability and satisfaction. Hansgrohe ShowerSelect Trims are available with square or round escutcheon plate.



ShowerSelect Square
Thermostatic 1-Function Trim



ShowerSelect Square
Thermostatic 2-Function Trim



ShowerSelect Round
Thermostatic 1-Function Trim



ShowerSelect Round
Thermostatic 2-Function Trim

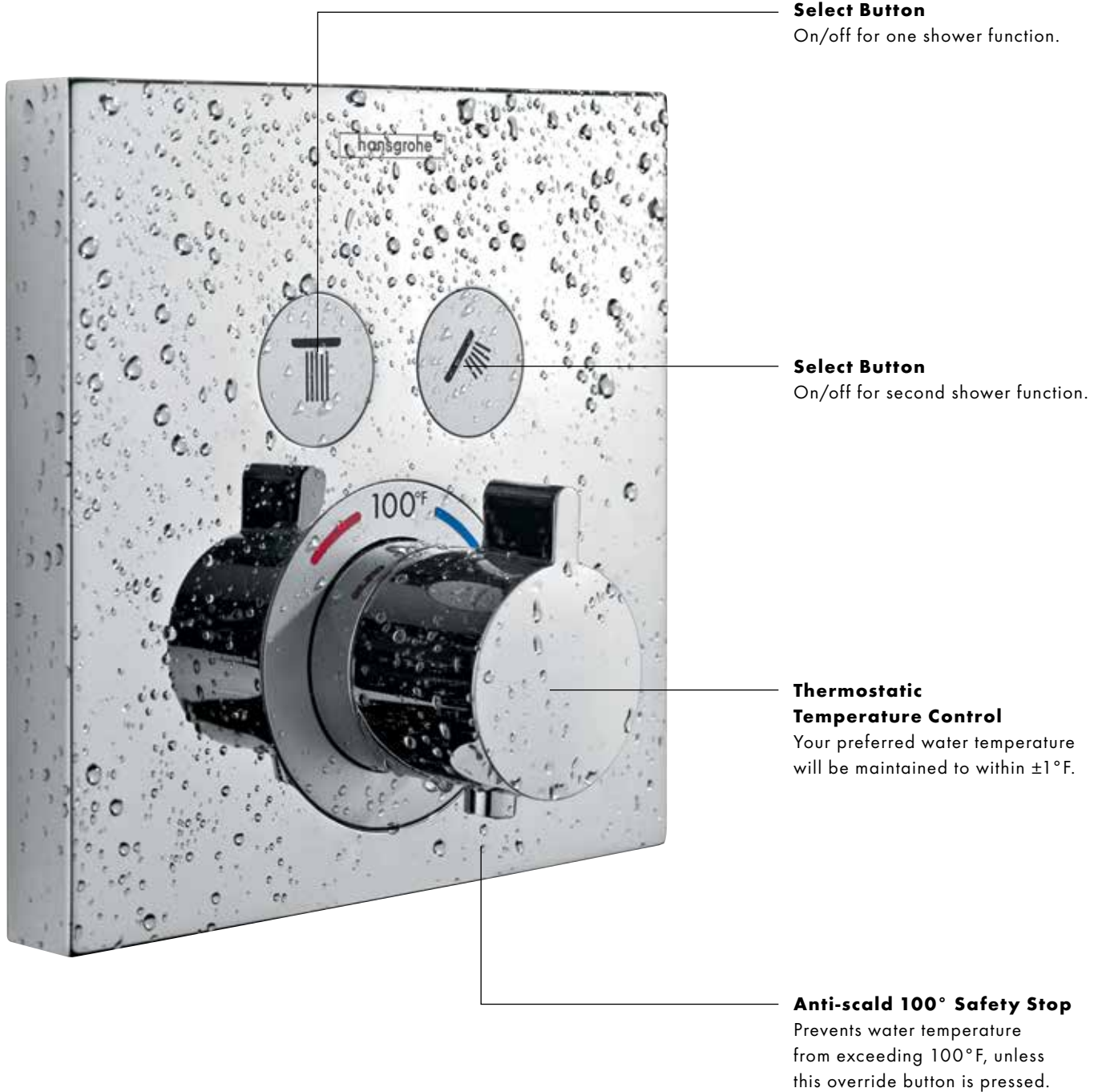

Select Button
On/off for one shower function.

Select Button
On/off for second shower function.

Thermostatic Temperature Control
Your preferred water temperature will be maintained to within $\pm 1^\circ\text{F}$.

Anti-scald 100° Safety Stop
Prevents water temperature from exceeding 100°F, unless this override button is pressed.



Products displaying "ADA" will meet actuation force requirements outlined in the Americans with Disabilities Act and ICC/ANSI A117.1

SELECT



ShowerSelect: Push to Transform Your Shower

Form and function go hand in hand with Hansgrohe ShowerSelect trims. From intuitive, user-friendly

controls to easy cleaning: a Hansgrohe ShowerSelect trim is the ideal foundation for creating the

ultimate shower experience. Your customers will love the many advantages of the Hansgrohe



Intuitive.
Simple Select button makes operation easy.



Distinct.
Easy to understand, scratch-resistant icons clearly indicate shower functions.



Easy.
The button for the active function clearly protrudes, for easy intuitive operation.



Comfortable.
An ergonomic handle helps you get a grip on your perfect water temperature.



Clean.
The buttons are flush with the trim plate, leaving a flat, easy-to-clean surface.



Efficient.
Push on. Push off. No-hassle functionality encourages less water use.

ShowerSelect Button Extension For Greater Accessibility

The Select buttons can be installed in a position that slightly protrudes from the trim plate in the off position by using the included

extension caps, enabling those with limited mobility to use an elbow or fist to operate the trim.

Without Extension Caps



Select button closed and flush with trim



Select button open

With Extension Caps



Select button closed and slightly protruded



Select button open

ShowerSelect Trim Installation



Install Rough

Follow the installation as shown on page 8 and ensure the joint between the rough and the finished wall is sealed with silicone.



Install Function Block

Remove flushing insert, install the function block by using the four mounting screws provided. Re-open service stops to turn on water supply.



Shorten Button Extensions

Cut the button extension(s) flush with the supplied template. Smooth any irregularities with sandpaper to leave a level surface.



Adjust Center Screw

With a 4 mm Allen key, unscrew the center screw until it is flush with the inner edge of the template.



Remove Spring Retainers

Remove the template and pull upwards to remove the spring retainer(s). For alternate button installation, insert extension caps, if desired.



Adjust Screw Length

Measure the length of the plastic screws of the carrier plate. Use pliers to shorten the plastic screws to the calculated length.



Install Carrier Plate

Use the cut-to-size plastic screws to attach the carrier plate to the iBox housing.



Install Buttons

Select the corresponding shower functions from among the 5 buttons included with the trim set.



Completed Installation

For information on installation of the rubber wall seal, escutcheon plate, and temperature handle, please refer to page 9.



Installation Video

For more information, scan for a video on ShowerSelect trim installation.



ShowerSelect Thermostatic 1-Function Trim

Thermostatic offers many advantages over pressure balance valves, and with ShowerSelect trims – easy, intuitive push-button control is also added to the list. One push to

turn water on, and one to shut off. The result is a shower installation with a refined, architectural look, combined with easy, ergonomic control for all users.

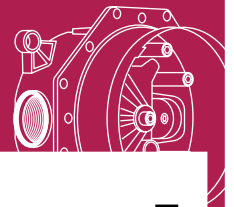

Hansgrohe
Planning Example

1

**❶ iBox Universal Plus Rough
with Service Stops, 3/4"**
#01850181

**❷ ShowerSelect Round
Thermostatic 1-Function Trim**
#15744xx1
Thermostatic temperature control
and on/off for one shower function

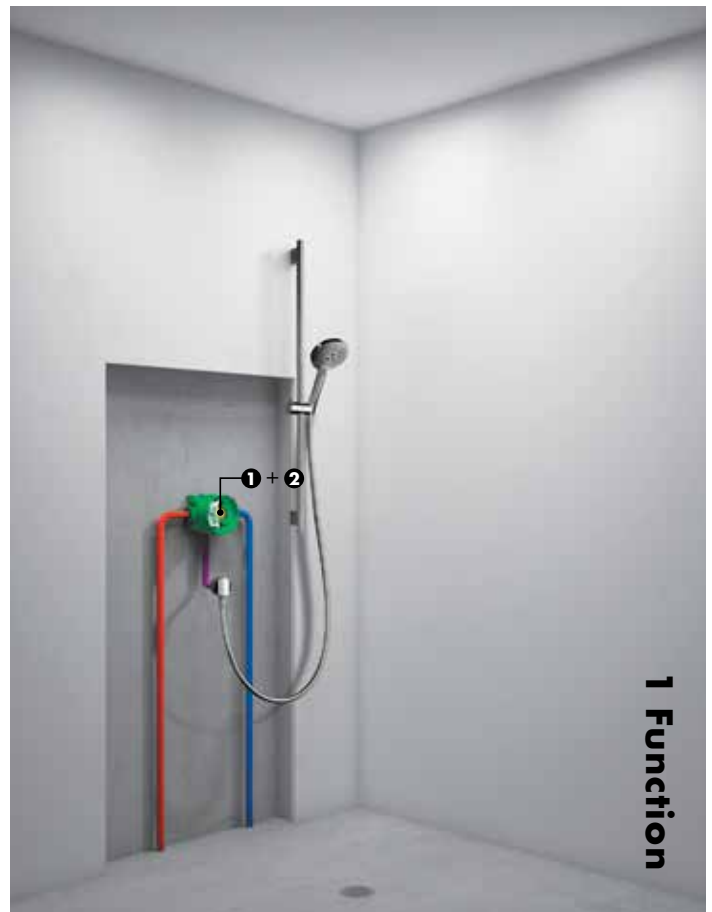



ShowerSelect Thermostatic 2-Function Trim

A triumvirate of Select products. In addition to the ShowerSelect trim with push-button functionality, both the overhead shower and the handshower shown in this installation

feature Select technology. Select your shower functions, and select your spray mode on each of the shower components. All at the touch of a button.

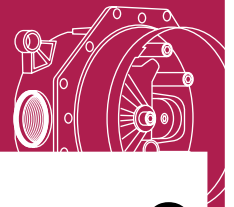

Hansgrohe
Planning Example

2

❶ **iBox Universal Plus Rough
with Service Stops, 3/4"**
#01850181

❷ **ShowerSelect Square
Thermostatic 2-Function Trim**
#15763xx1
Thermostatic temperature control
and on/off for two shower functions



Create Your Ideal Shower Installation with Standard Hansgrohe Trim Styles

We all know that living spaces are as individual as the people who live in them. Hansgrohe's World of Styles offers three comprehensive style worlds from which to create a

distinctive, personalized design for the bathroom. Choose a trim style from any of the three style worlds: Avantgarde (PuraVida), Modern (S or S/E), or Classic (C). These

universal trims coordinate seamlessly with lavatory faucets from any product series within the same Hansgrohe style world.



Avantgarde.

Modern.



Classic.



Volume Control and Diverter

Controls volume and also acts as a diverter between two functions on specific models.



Anti-scald 100° Safety Stop

Prevents water temperature from exceeding 100°F, unless this override button is pressed, protecting against water scalding.

Thermostatic Temperature Control

Preset your preferred water temperature to within $\pm 1^\circ\text{F}$.

Standard Hansgrohe Trim Options: Function and Choice

With a variety of mixing valves and diverters, Hansgrohe gives you more options than ever to create the

perfect shower. A type of volume control is integrated into all Hansgrohe brand trims, so

a separate volume control is not required.

Exemplary Hansgrohe S trims shown



Thermostatic Trim with Volume Control

Volume and thermostatic temperature control for one shower function

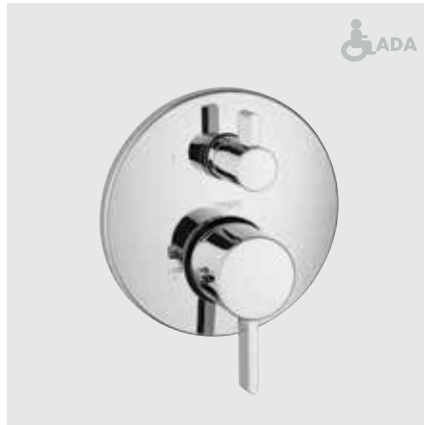

Thermostatic Trim with Volume Control and Diverter

Volume and thermostatic temperature control for two shower functions



Pressure Balance Trim

Volume and pressure-balanced temperature control for one shower function



Pressure Balance with Diverter Trim

Volume and pressure-balanced temperature control for two shower functions – ideal for tub/shower installations

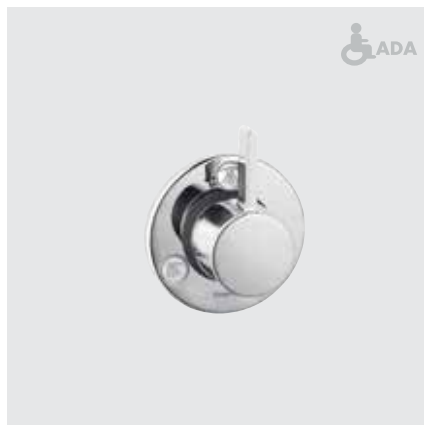

Quattro 3-Way Diverter

Selects between three functions or a combination of any two

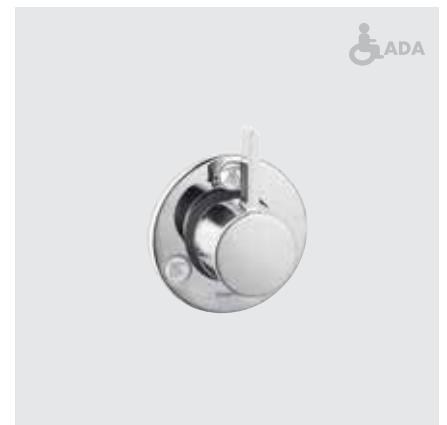

Trio 2-Way Diverter

Selects between two functions or a combination of both

Quattro Green 3-Way Diverter

Selects between three functions (no shared function)



Thermostatic with Volume Control

Enjoy the benefits of both a handshower and a fixed showerhead by choosing a Hansgrohe wallbar set. Then add a Hansgrohe thermostatic

trim, featuring integrated temperature and volume control. The result: a versatile high-performance thermostatic shower that is extremely easy to install.

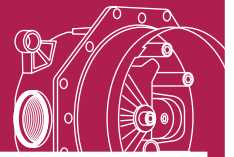

Hansgrohe
Planning Example

3

1 iBox Universal Plus Rough with Service Stops, 3/4"
#01850181

2 S/E Thermostatic Trim with Volume Control
#04352xx0
Thermostatic temperature and volume control for one shower function



1 Function



Thermostatic with Volume Control and Diverter

Europeans have embraced the advantages of a handshower over a fixed showerhead for years. A handshower delivers a more invigorating shower, through the increased warmth and intensity that

results from bringing the spray closer to your body. An oversized PuraVida 400 AIR 1-Jet showerhead and thermostatic trim with volume control and diverter complete this exhilarating shower installation.

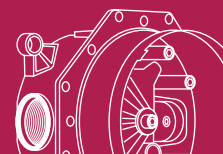

Hansgrohe
Planning Example

4

1 iBox Universal Plus Rough with Service Stops, 3/4"
#01850181

2 PuraVida Thermostatic Trim with Volume Control and Diverter
#15771xx1
Thermostatic temperature control, volume control and diverter for two shower functions



2 Functions



Thermostatic with Volume Control plus Quattro Diverter

With the numerous installation options made possible by the Quattro and Quattro Green 3-Way Diverter, your imagination is the only limit.

The Quattro 3-Way Diverter brings ambitious possibilities to Hansgrohe showers, with the ability to control 3 separate shower functions.

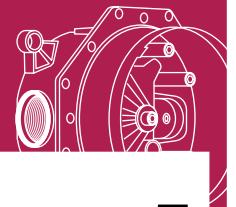

Hansgrohe
Planning Example

5

1 iBox Universal Plus Rough with Service Stops, 3/4"
#01850181

2 C Thermostatic Trim with Volume Control
#15752xx1
Thermostatic temperature and volume control

3 Rough, Quattro 3-Way Diverter, 3/4"
#15930181
or
Rough, Quattro Green 3-Way Diverter, 3/4"
#15936181

4 C Trio/Quattro Trim
#15934xx1
Selects between showerhead, handshower, and bodysprays





Pressure Balance Valve

This configuration incorporates a single wall-mounted showerhead – a perfect fit for secondary bathrooms. With its elegant simplicity and functionality, the S Pressure Balance

Trim delivers streamlined looks as well as installation. With the iBox Universal Plus rough behind the wall, easily upgrade from pressure balance thermostatic trim at a later date.

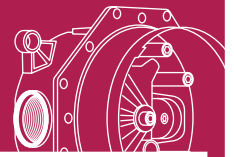

Hansgrohe
Planning Example

6

❶ iBox Universal Plus Rough with Service Stops, 3/4"
#01850181

❷ S Pressure Balance Trim
#04233xx0
Temperature and volume control for one shower function

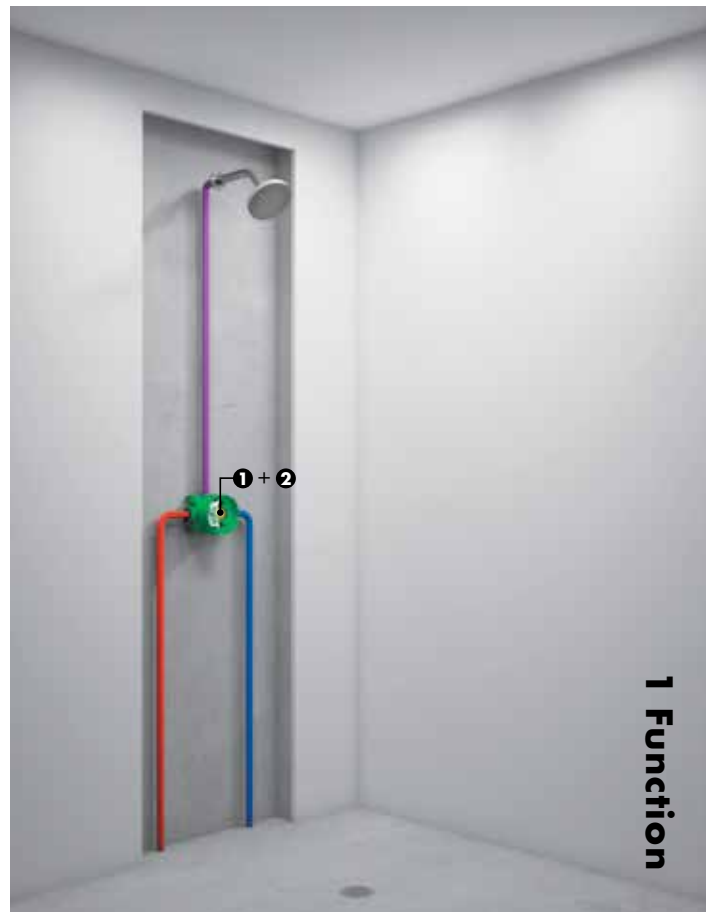



Pressure Balance Valve with Diverter

With the Pressure Balance with Diverter trims, standard tub/shower solutions are easier to install than ever before. When installed along with a tub spout without a diverter,

the result is a cleaner, more streamlined look and offers the same ease of installation – as well as affordability.

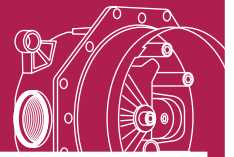

Hansgrohe
Planning Example

7

**1 iBox Universal Plus Rough
with Service Stops, 3/4"**

#01850181

**2 C Pressure Balance Trim
with Diverter**

#04449xx0

Temperature and volume control for one shower function plus a diverter to control the tub spout



2 Functions



Pressure Balance Valve with Diverter

Hansgrohe shows that a typical tub/shower installation can be anything but ordinary. A Raindance wallbar with pivot ball action delivers the benefit of a fixed showerhead with the ability to easily reposition

the handshower to suit the needs of multiple users, or to target specific areas of the body. The Metris non-diverter tub spout rounds out this installation – made possible by this Pressure Balance Valve with Diverter.

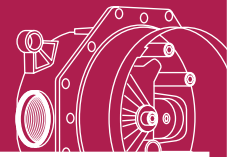

Hansgrohe
Planning Example



1 iBox Universal Plus Rough with Service Stops, 3/4"

#01850181

2 S/E Pressure Balance Trim with Diverter

#04448xx0

Temperature and volume control for one shower function plus a diverter to control the tub spout





Special Applications — iBox Universal Plus

The iBox Universal Plus rough earns its world-class reputation as the foundation for mixing valves, but it also serves as the foundation for a variety of specialized multi-function

shower applications. It provides a conduit for water from the supply lines, and provides additional structural support to ensure smooth, reliable operation for years to come.

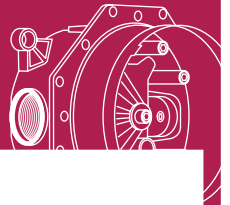

Hansgrohe
Special Applications



Raindance Rainfall AIR 240 3-Jet Showerhead Trim (2.5 GPM)

#28411001

One iBox Universal Plus is required for the Raindance Rainfall AIR 240 3-Jet Showerhead Trim, a second iBox Universal Plus rough is required for the thermostatic trim



Raindance Rainfall AIR 180 2-Jet Showerhead Trim (2.5 GPM)

#28433, -001, -401

One iBox Universal Plus is required for the Raindance Rainfall AIR 180 2-Jet Showerhead Trim, a second iBox Universal Plus rough is required for the thermostatic trim



Raindance E 420 AIR 2-Jet Showerhead with Showerarm (2.5 GPM)

#27373, -001, -821, -831

One iBox Universal Plus is required for the Raindance E 420 AIR 2-Jet Showerhead, a second iBox Universal Plus rough is required for the thermostatic trim

Hansgrohe ShowerSelect Trims



Trim (Max. Flow Rate @ 44 PSI)

ShowerSelect Square

ShowerSelect Square

ShowerSelect Round

ShowerSelect Round

ShowerSelect Thermostatic 1-Function Trim (7 GPM)

15762xx1

-

15744xx1

-

ShowerSelect Thermostatic 2-Function Trim (8 GPM)

-

15763xx1

-

15743xx1

Needs iBox Universal Plus Rough #01850181



Available Finishes:

-00, -82

-00, -82

-00, -82

-00, -82

When ordering, replace "xx" in trim part numbers with the corresponding finish code:

Chrome -00, White/Chrome -40, Brushed Nickel -82, Polished Nickel -83, Rubbed Bronze -92

Hansgrohe Shower Planning Tips

- Separate volume controls cannot be used with any Hansgrohe trims
- Tub spout with diverter can only be used with pressure balance trims which do not contain a built-in diverter
- ShowerSelect trims feature an on/off type water control. Further volume adjustment is not possible.

Standard Hansgrohe Trims



Trim (Max. Flow Rate @ 44 PSI)

PuraVida

S

S/E

C

Thermostatic Trim with Volume Control (6 GPM)	15775xx1	04230xx0	04352xx0	15752xx1
Thermostatic Trim with Volume Control and Diverter (7 GPM)	15771xx1	04231xx0	04353xx0	15753xx1
Pressure Balance Trim (5.5 GPM)	15407xx1	04233xx0	04355xx0	15404xx1
Pressure Balance Trim with Diverter (4.5 GPM)	-	04447xx0	04448xx0	04449xx0
Needs iBox Universal Plus Rough #01850181				
Trio/Quattro Trim	15937xx1	04232xx0	04354xx0	15934xx1
Rough, Quattro 3-Way Diverter, 3/4" (17 GPM)	15930181	15930181	15930181	15930181
Rough, Quattro Green 3-Way Diverter, 3/4" (17 GPM)	15936181	15936181	15936181	15936181
Rough, Trio 2-Way Diverter, 3/4" (17 GPM)	15984181	15984181	15984181	15984181

Available Finishes:

-00, -40

-00, -82

-00, -82

-00, -82, -83, -92

Finishes

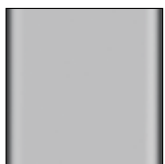

Chrome
-00



White/Chrome
-40

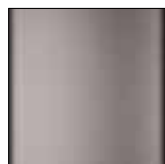

Brushed Nickel
-82

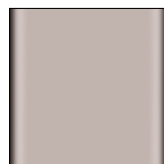

Polished Nickel
-83



Rubbed Bronze
-92

AXOR: DESIGNER VISIONS FOR THE BATHROOM

In 1994, Axor and Philippe Starck transformed the idea of what a bathroom could be – from its origin as a small, purely functional room to a personalized retreat, tailored to the

users wants and needs. Axor continues its commitment to find the best solutions for the bathroom by partnering with internationally-renowned designers and architects.

The variety of Axor trims for iBox allows you to bring a multitude of ambitious visions for shower installations to life – from the minimalist to the luxurious.



Axor Standard Trim Options: A Wealth Of Options

The Axor brand contains a wealth of options to build a range of personalized shower systems. In addition to the 13 GPM

highflow thermostatic trims which require an additional volume control, all Axor collections offer thermostatic trims with integrated volume control

and optional diverter – unlocking even more potential to create the perfect shower system.

Exemplary Axor Citterio trims shown:

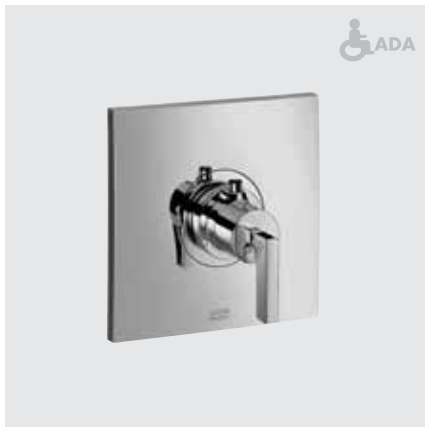

Thermostatic Trim, Highflow*
Thermostatic temperature control

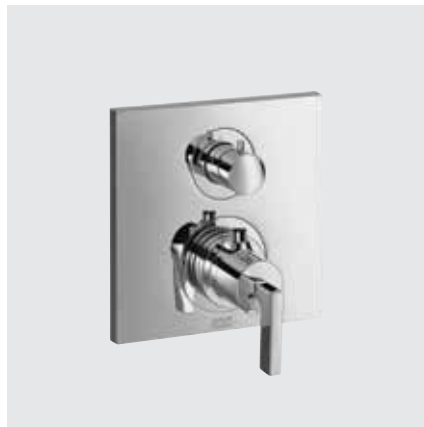

**Thermostatic Trim with Volume Control/
Thermostatic Trim with Volume Control and Diverter**
Volume and thermostatic temperature control for one or two shower functions

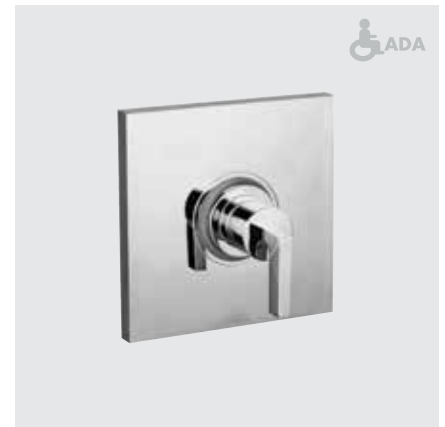

Pressure Balance Trim
Volume and pressure-balanced temperature control

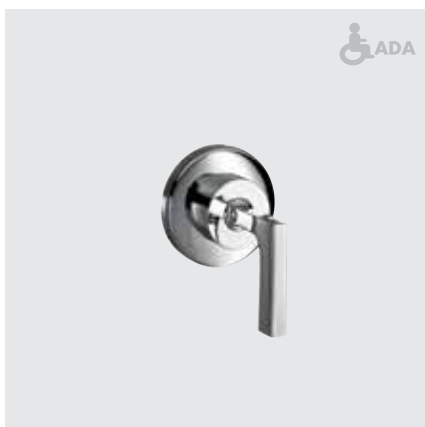

Volume Control Trim
Controls volume and shuts off water

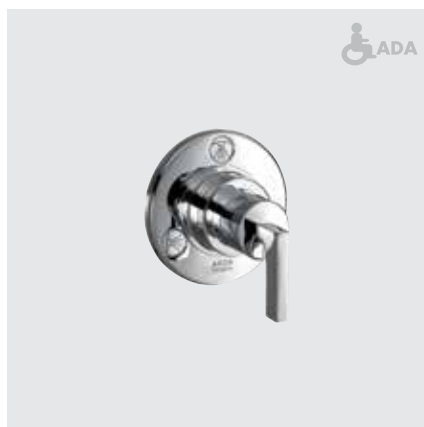

Quattro 3-Way Diverter
Selects between three functions or a combination of any two

Quattro Green 3-Way Diverter
Selects between three functions (no shared function)

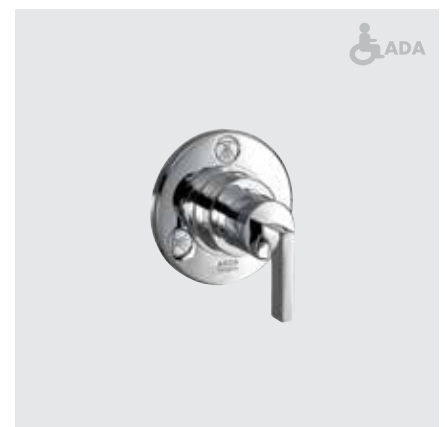

Trio 2-Way Diverter
Selects between two functions

Trio 2-Way Diverter with Shut-Off
Selects between two functions and shuts off water

*Requires additional volume control

Form and Function: Axor ShowerSelect Thermostatic Trims

The Axor brand is never content with the status quo, and this is evident in the latest range of thermostatic trims: Axor ShowerSelect. The clean,

minimalist design of the Select button with easily identifiable markings makes it easy to understand at a glance how to control your shower,

simply by pressing a button. With three separate trim plate designs, Axor ShowerSelect can be easily combined with any Axor collection.





The Select buttons come in high-contrast black, for both chrome and brushed nickel trims.



Each 2-function trim set includes 5 interchangeable buttons, with the following icons: Showerhead, Waterfall, Handshower, Bodyspray, and Bathtub.

SELECT BUTTON

On/off for one shower function.

SELECT BUTTON

On/off for second shower function.

ANTI-SCALD 100° SAFETY STOP

Prevents water temperature from exceeding 100°F, unless this override button is pressed.

THERMOSTATIC TEMPERATURE CONTROL

Preset your preferred water temperature to within $\pm 1^\circ\text{F}$.

METAL TRIM PLATE

The all-metal trim plate delivers maximum durability and a high-value feel. Axor ShowerSelect trims are available in square, SoftCube and round shapes, so they can be combined harmoniously with any Axor collection.





ShowerSelect Thermostatic 2-Function Trim

The Axor brand is known for its depth of shower trim options which can be used to create the utmost in luxurious showers. Axor ShowerSelect trims are a fantastic addition to the

range of Axor trims. These trims feature all-metal plates in round, square, or SoftCube shapes, as well as buttons in a gloss black finish, making them easy to read.

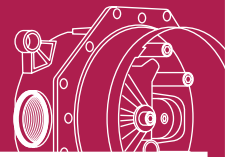

Axor
Planning Example

1

1 iBox Universal Plus Rough with Service Stops, 3/4"
#01850181

2 Axor ShowerSelect SoftCube Thermostatic 2-Function Trim
#36707xx1
Thermostatic temperature control and on/off for two shower functions



2 Function



Thermostatic with Volume Control

With integrated volume control, this thermostatic trim option unfolds countless possibilities. Combine with a wallbar set and maximize functionality, while minimizing the

necessary plumbing installation. This installation allows for a clutter-free wall, for a clean look that is a perfect complement to any setting – modern, traditional, or eclectic.

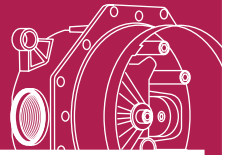

Axor
Planning Example

2

1 iBox Universal Plus Rough with Service Stops, 3/4"
#01850181

2 Axor Citterio M Thermostatic Trim with Volume Control
#34705xx1

Thermostatic temperature and volume control for one shower function

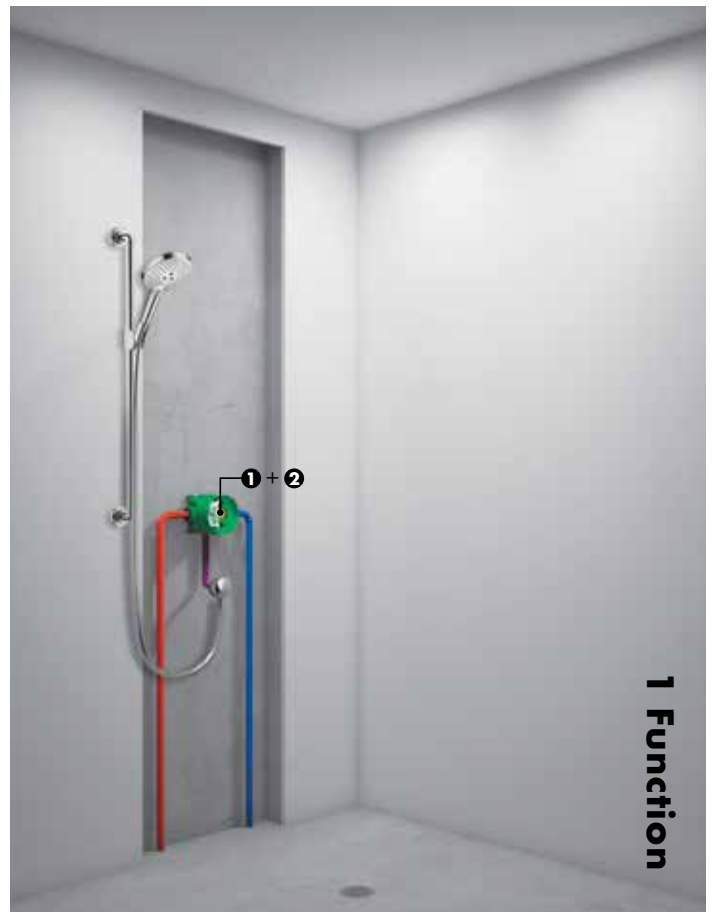



Thermostatic with Volume Control and Diverter

The Axor LampShower designed by Nendo, combined with Axor Urquiola trim and handshower holder, delivers two distinct showering experiences. The trim combines

thermostatic temperature control, volume control, and diverter, for a streamlined installation, without the need for separate volume control or diverter trims.

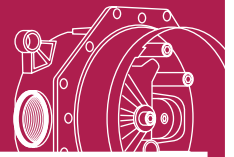

Axor
Planning Example

3

1 iBox Universal Plus Rough with Service Stops, 3/4"
#01850181

2 Axor Urquiola Thermostatic Trim with Volume Control and Diverter
#11733001

Thermostatic temperature control, volume control and diverter for two shower functions

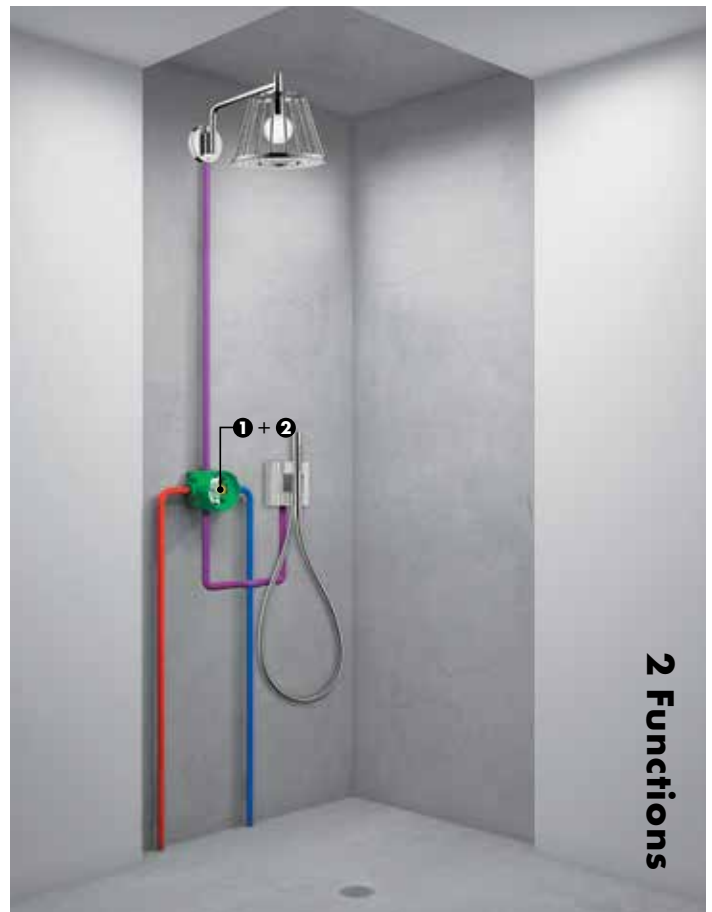

2 Functions

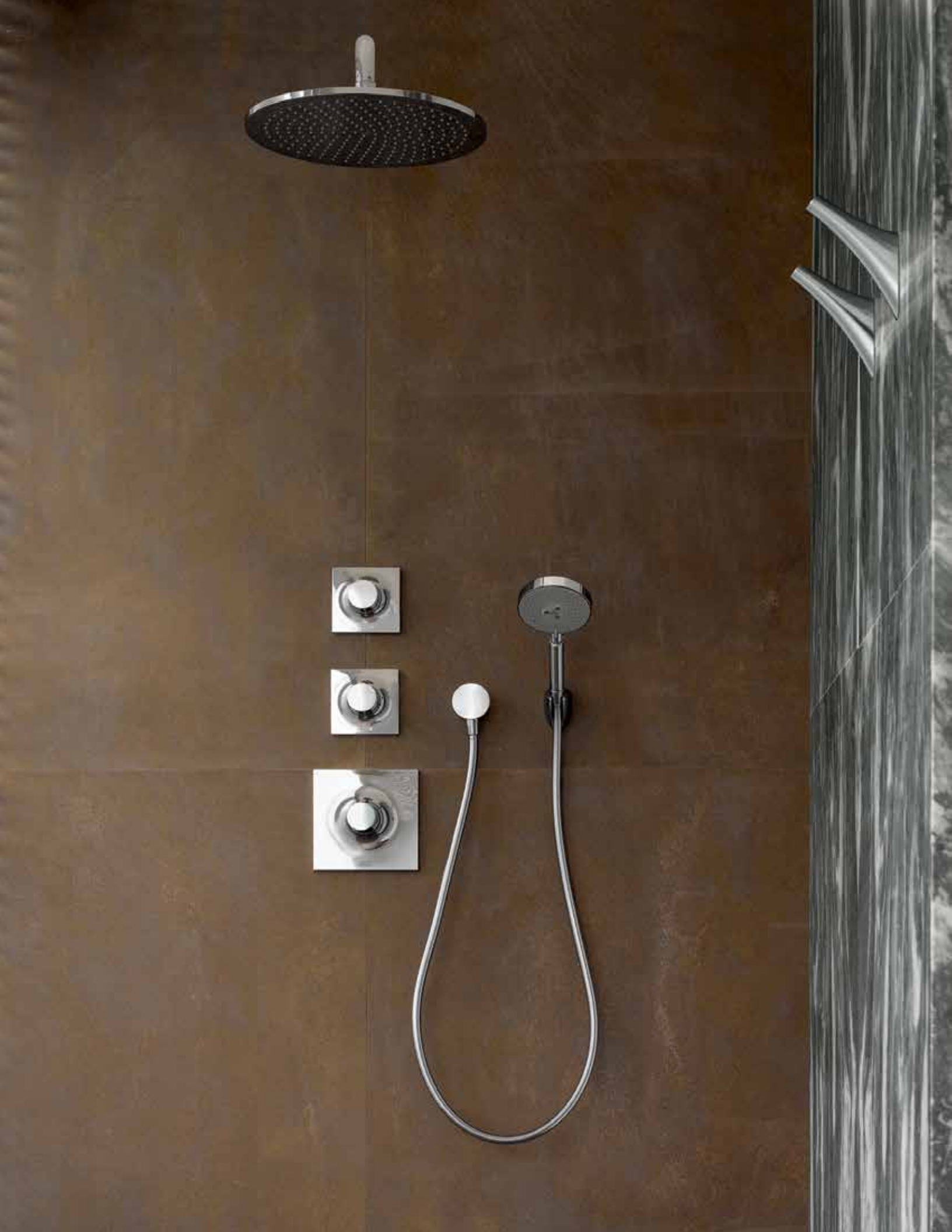

Thermostatic plus Two Volume Controls

Fine-tuning your Axor showering experience is as natural as it is intuitive in this shower configuration. The two volume controls allow you to operate the two shower functions independently. Boost the handshower

without altering the showerhead setting, or vice versa. Arrive at the perfect balance by turning both volume controls at once, then shut off the water using the same controls.

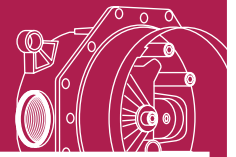

Axor
Planning Example

4

**❶ iBox Universal Plus Rough
with Service Stops, 3/4"**
#01850181

**❷ Axor Massaud
Thermostatic Trim**
#18741001
Thermostatic
temperature control

**❸ (2x) Rough,
Volume Control**
#15977181

**❹ (2x) Axor Massaud
Volume Control Trim**
#18974001

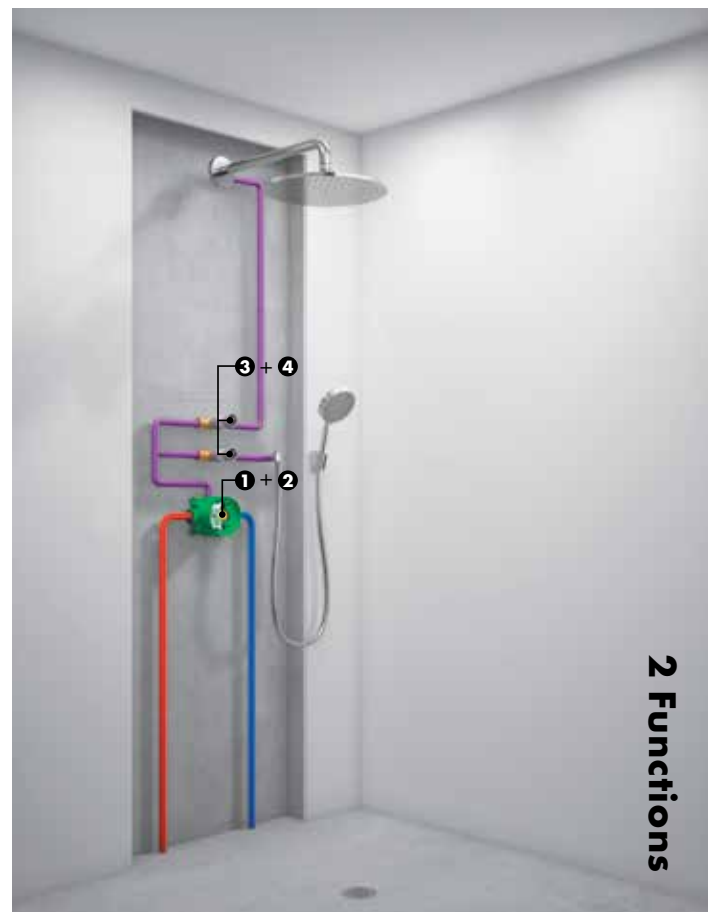

2 Functions



Thermostatic plus Trio Diverter with Shut-Off

Traditional style meets modern shower technology with Axor Montreux. The Trio 2-Way Diverter with Shut-Off allows you to minimize the number of controls on the wall: One handle selects between two

shower functions or a combination, and shuts off the water. Axor Montreux trims are available with cross or lever handles, giving you additional options to build your shower system.

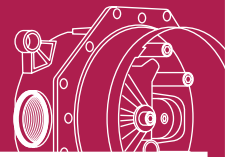

Axor
Planning Example

5

**1 iBox Universal Plus Rough
with Service Stops, 3/4"**
#01850181

**2 Axor Montreux
Thermostatic Trim
with Cross Handle**
#16816xx1
Thermostatic
temperature control

**3 Rough, Trio 2-Way
Diverter with Shut-Off, 3/4"**
#15981181
Selects between showerhead
and handshower or a
combination of both, plus
shuts off water

**4 Axor Montreux
Trio/Quattro
Diverter Trim
with Cross Handle**
#16833xx1



2 Functions



Thermostatic plus Trio Diverter with Shut-Off and Fix Fit Wall Outlet

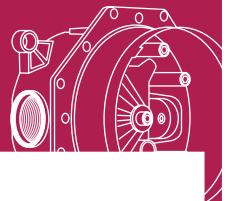

Axor
Planning Example

6

Unlock the ultimate in shower pleasure. With Axor thermostatic trims delivering an ample 13 GPM, the most sophisticated shower systems are made possible. This impressive

configuration incorporates six bodysprays, a showerhead and a handshower – plus the capability to operate all functions simultaneously. Luxury reinvented for the shower.

1 iBox Universal Plus Rough with Service Stops, 3/4"
#01850181

2 Axor Citterio Thermostatic Trim with Lever Handle
#39711xx1
Thermostatic temperature control

3 Rough, Trio 2-Way Diverter with Shut-Off, 3/4"
#15981181
Selects between showerhead, bodysprays or a combination of both, plus shuts off water

4 Axor Citterio Trio/Quattro Diverter Trim with Lever Handle
#39931xx1

5 Axor Citterio Fix Fit Wall Outlet with Lever Handle
#39882xx1
Controls volume for handshower and shuts off water

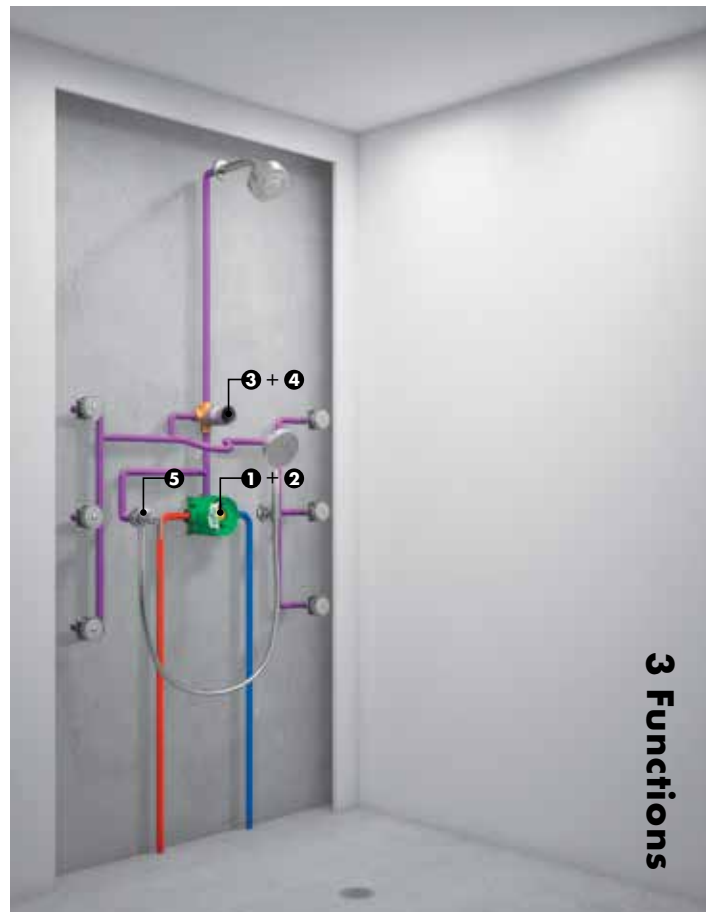

3 Functions



Pressure Balance Valve

Complement the beautiful, minimalist forms of Axor Starck by taking a similar approach to design your shower configuration. By adding a pressure balance trim with a single

handle to control temperature and volume to a wallbar featuring the Axor Starck handshower, Philippe Starck's vision remains intact.

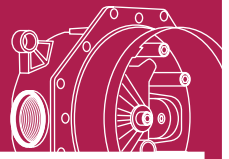

Axor
Planning Example

7

1 iBox Universal Plus Rough with Service Stops, 3/4"
#01850181

2 Axor Starck Pressure Balance Trim
#10407xx1
Temperature control and volume control

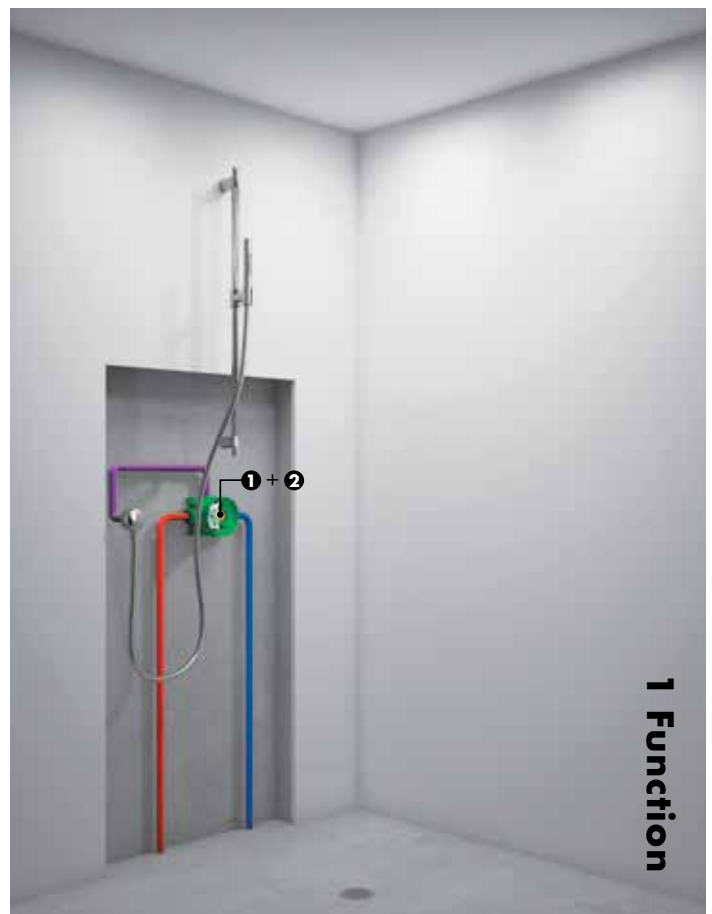

Axor ShowerSelect Trims



ShowerSelect Square



ShowerSelect Square

Trim (Max. Flow Rate @ 44 PSI)

ShowerSelect Thermostatic 1-Function Trim (7 GPM)

36714xx1

-

ShowerSelect Thermostatic 2-Function Trim (8 GPM)

-

36715xx1

Needs iBox Universal Plus Rough #01850181



Available Finishes:

-00, -82

-00, -82

When ordering, replace "xx" in trim part numbers with the corresponding finish code:
 Chrome -00, Brushed Nickel -82

Axor ShowerSelect Shower Planning Tips

- Separate volume controls cannot be used with ShowerSelect trims
- ShowerSelect trims feature an on/off type water control. Further volume adjustment is not possible.



**ShowerSelect
SoftCube**



**ShowerSelect
SoftCube**



**ShowerSelect
Round**



**ShowerSelect
Round**

36705xx1

-

36722xx1

-

-

36707xx1

-

36723xx1



-00, -82



-00, -82



-00, -82



-00, -82

Finishes

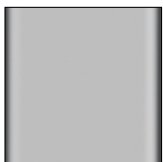

Chrome
-00



Brushed Nickel
-82

Standard Axor Trims







Trim (Max. Flow Rate @ 44 PSI)

Axor Starck

Axor Starck X

Axor Starck Organic

Axor Bouroullec

Thermostatic Trim with Volume Control (6 GPM)	10700001	10706001	12715001	19704001
Thermostatic Trim with Volume Control and Diverter (7 GPM)	10720001	10726001	12716001	19706001
Thermostatic Trim, Highflow (13 GPM)	10715xx1	10717001	12711001	19702001
Pressure Balance Trim (5.5 GPM)	10407xx1	10404001	-	19408001
Needs iBox Universal Plus Rough #01850181				

Volume Control Trim	10970xx1	10974001	12771001	19971001
Rough, Volume Control, 1/2" (10.5 GPM)	15974181	15974181	10971181	15974181
Rough, Volume Control, 3/4" (35 GPM)	15977181	15977181	15977181	15977181

Trio/Quattro Trim	-	10934001	12731001	19981001
Rough, Quattro 3-Way Diverter, 3/4" (17 GPM)	15930181	15930181	15930181	15930181
Rough, Quattro Green 3-Way Diverter, 3/4" (17 GPM)	15936181	15936181	15936181	15936181
Rough, Trio 2-Way Diverter, 3/4" (17 GPM)	15984181	15984181	15984181	15984181
Rough, Trio 2-Way Diverter with Shut-Off, 3/4" (17 GPM)	15981181	15981181	15981181	15981181

Available Finishes: -00, -82 -00 -00 -00 -00

When ordering, replace "xx" in trim part numbers with the corresponding finish code:
 Chrome -00, Brushed Nickel -82, Polished Nickel -83

Axor Shower Planning Tips

- Axor highflow thermostatic trims require a type of volume control (Volume Control, Trio 2-Way Diverter with Shut-Off, or Fix Fit Wall Outlet)
- Axor Trio (without shut-off) and Quattro trims require a type of volume control
- Separate volume controls (Volume Control, Trio 2-Way Diverter with Shut-Off, or Fix Fit Wall Outlet) cannot be used with pressure balance trims, or thermostatic trims with volume control or volume control and diverter
- Tub spout with diverter can only be used with pressure balance trims



Axor Citterio



Axor Citterio M



Axor Urquiola



Axor Massaud



Axor Uno



Axor Montreux

34705xx1

34705xx1

11732001

18745001

-

16801xx1

39700xx1

34725xx1

11733001

18750001

-

16821xx1

39716xx1—Cross
39711xx1—Lever

34714xx1

11731001

18741001

38715xx1

16816xx1—Cross
16824xx1—Lever

39720xx1

34808xx1

11408001

18978001

38418xx1

16508xx1



39967xx1—Cross
39961xx1—Lever

34964xx1

11960001

18974001

38974xx1

16873xx1—Cross
16872xx1—Lever

15974181

15974181

15974181

15974181

15974181

15974181

15977181

15977181

15977181

15977181

15977181

15977181

39927xx1—Cross
39931xx1—Lever

34934xx1

11925001

18934001

38934xx1

16833xx1—Cross
16832xx1—Lever

15930181

15930181

15930181

15930181

15930181

15930181

15936181

15936181

15936181

15936181

15936181

15936181

15984181

15984181

15984181

15984181

15984181

15984181

15981181

15981181

15981181

15981181

15981181

15981181

-00, -82

-00, -82

-00

-00

-00, -82

-00, -82, -83

Cross or Lever handle option is available for the indicated trims.

Finishes

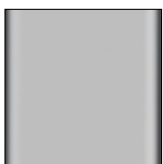

Chrome
-00

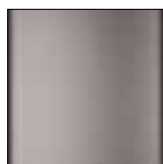

Brushed Nickel
-82

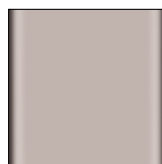

Polished Nickel
-83

Pipework and Wall Construction Compatibility

The iBox Universal Plus rough is compatible with all commonly-used constructions and pipework systems, $\frac{3}{4}$ " or $\frac{1}{2}$ ".

Pipework



PEX



Copper



CPVC

Wall Construction

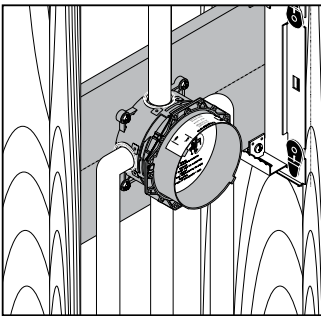

Mounting between two wall studs

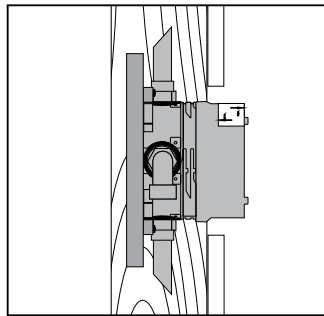

Installation with #96615000 installation set

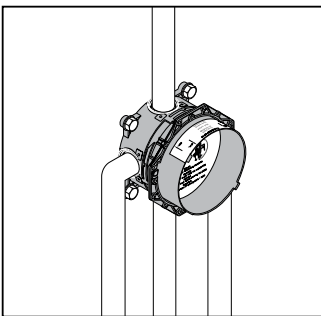
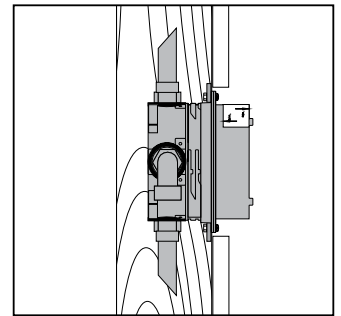
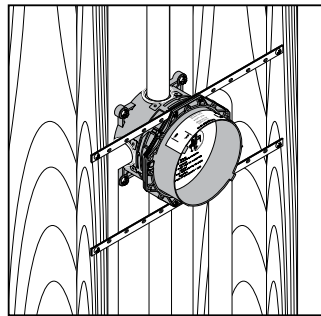

Installation on the wall

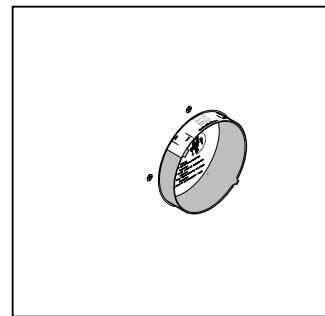
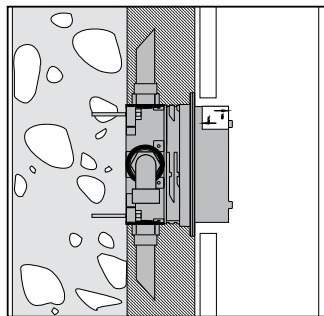

Installation on a prefabricated wall

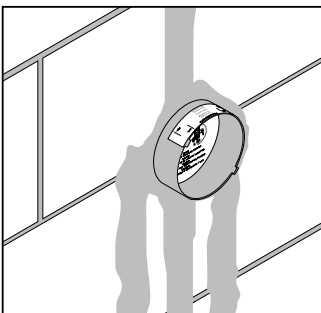
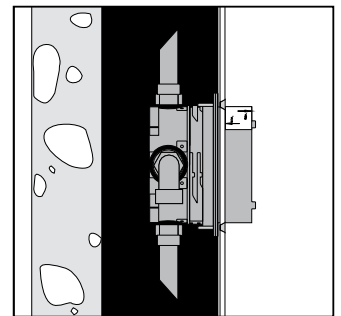

Installation inside of the wall

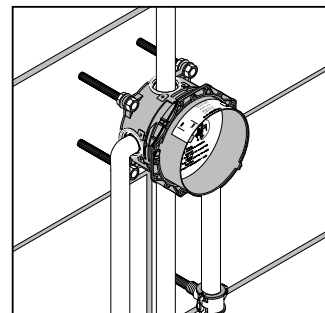
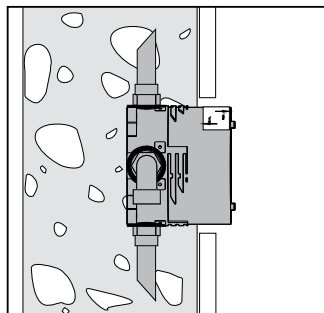

Installation in front of the wall (shown with variable spacers)

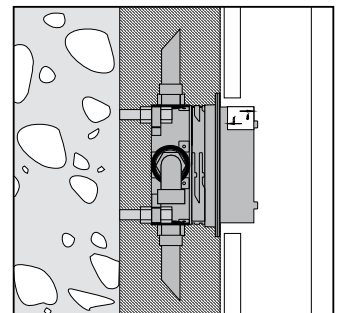

Extension and Installation Sets

The special installation aids below allow easy installation of the iBox, even in difficult situations.



**Shallow Extension Set,
Thermostatic/
Pressure Balance Trim, 7/8"**
#13596xx0

- Permits installation of trim escutcheons when rough is installed too shallow in the wall
- Fits all Hansgrohe S, S/E, and C trims
- Fits Axor Starck, Axor Uno, and Axor Montreux trims

-00, -82, -83, -92



**Shallow Extension Set,
PuraVida Thermostatic/
Pressure Balance Trim, 7/8"**
#15597000

- Permits installation of trim escutcheons when rough is installed too shallow in the wall
- Fits Hansgrohe PuraVida trims



**Shallow Extension Set,
Thermostatic/
Pressure Balance Trim, 7/8"**
#97407xx0

- Permits installation of trim escutcheons when rough is installed too shallow in the wall
- Fits Axor Starck X, Axor Starck Organic Axor Citterio, and Axor Massaud trims

-00, -82



**Shallow Extension Set,
Thermostatic/
Pressure Balance Trim, 7/8"**
#98860xx0

- Permits installation of trim escutcheons when rough is installed too shallow in the wall
- Fits Axor Citterio M and Axor Urquiola trims

-00, -82



**Shallow Extension Set,
Thermostatic/
Pressure Balance Trim, 7/8"**
#19427000

- Permits installation of trim escutcheons when rough is installed too shallow in the wall
- Fits Axor Bouroullec trims



**Extension Set, iBox
Universal Plus Rough, 1"**
#13595000

- Fits iBox Universal Plus Rough #01850181
- Permits installation when iBox is installed too deep in the wall



**Extension Set,
Volume Control
and Trio/Quattro, 1"**
#96370000

- Permits installation when Volume Control or Trio/Quattro diverter rough is installed too deep in the wall



**Installation Set,
iBox Universal Plus Rough**
#96615000

- Fits iBox Universal Plus Rough #01850181
- Permits secure, easy installation of iBox between studs in wall

Discover the world of Hansgrohe at www.hansgrohe-usa.com

iBox Universal Plus: Planning and Installation is a comprehensive guide for planning shower installations with iBox Universal Plus and Hansgrohe and Axor trims. Visit our website to view our full range of products, and to find a Hansgrohe dealer in your area at our Where-To-Buy section.

Axor®, Hansgrohe®, iBox®, PuraVida®, Raindance®, ShowerSelect™, and Rainfall® are trademarks of Hansgrohe, Inc. All Rights Reserved.

Customer Service

Located at our North American Headquarters in Alpharetta, Georgia, our expert associates are there to assist you. Call us at 800-334-0455, Monday through Friday, 8 am to 7 pm EST.

Join us on the social networks



/hansgroheusa



/hansgroheusa



/hansgroheusa



/hansgroheusa



/hansgroheusa



/hansgroheusa



Hansgrohe USA Virtual Library app for iPad

Enjoy digital versions of all current Hansgrohe literature on the go, and easily share the products you discover via Facebook or email!