

Hansgrohe ComfortZone Test

Für jedes Waschbecken die passende Armatur. Für zufriedene Kunden.



Lästige Wasserspritzer und -flecken durch nicht aufeinander abgestimmte Armatur-Waschbecken-Kombinationen – diese Situation ist Ihnen sicher bekannt. Der damit verbundene Kundenärger gehört ab sofort der Vergangenheit an.



Mit dem **Hansgrohe ComfortZone Test**, einem eigens entwickelten, realitätsnahen Prüfverfahren hat Hansgrohe alle Armaturen der ComfortZone mit den gebräuchlichsten Waschbecken führender Hersteller getestet. Bei diesem Funktionstest zwischen Armatur und Waschbecken wird der Freiraum unter der Armatur sowie das Spritzverhalten geprüft. Ausführlichere Informationen zum ComfortZone Test finden Sie unter:

www.pro.hansgrohe.ch/comfortzone-test

Keramiktypen

Zu den bekannten Waschbeckentypen finden Sie immer die passende Hansgrohe Armatur. Mit dem Hansgrohe ComfortZone Test erhalten Sie eine umfassende Beratungsunterlage für eine einwandfreie Montage von Waschtischarmatur und Waschbecken für ein komfortables und spritzfreies Händewaschen. Bei dem Hansgrohe ComfortZone Test wurden fünf unterschiedliche Keramiktypen getestet:

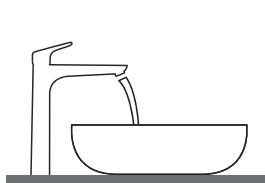

Die Waschschiessel mit Armatur dahinter

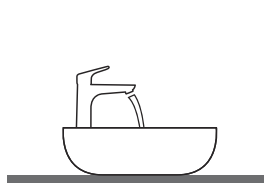

Die Waschschiessel mit Armatur darauf

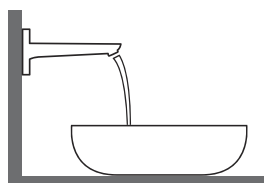

Die Waschschiessel mit Armatur an der Wand

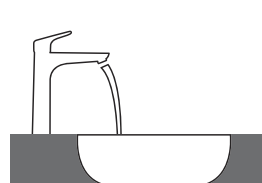

Das Unterbau- oder Aufsatzbecken mit freistehender Armatur

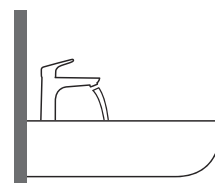

Das wandhängende Waschbecken mit Armatur darauf

Nutzen Sie jetzt kostenlos die Ergebnisse des ComfortZone Tests. Unter: www.pro.hansgrohe.ch/comfortzone-test

Anwendungshinweise

Im Folgenden finden Sie die einfache Arbeitsweise mit den Ergebnissen des Hangrohe ComfortZone Tests.

Hangrohe ComfortZone Armatur mit Artikelnummer (unterschiedliche Artikelnummern bezeichnen verschiedene Varianten von Ablaufgarnituren)

Hersteller und Waschbeckenlinie

Waschbecken mit Artikelnummer und Grössenangabe (unterschiedliche Artikelnummern bezeichnen verschiedene Hahnloch- und Überlaufvarianten)

Testergebnisse mit Duravit Waschbecken.pdf - Adobe Acrobat Pro

Erstellen | 12 / 14 | 99,2% | Suchen | Kommentar | Freigebe

hangrohe

Welche Hangrohe Armatur passt zu welchem Waschbecken?

Duravit	Vero	Waschbecken													
		250x450	500x250	485x315	595x465	550x465	850x490	1650x490	1250x490	600x470	800x470	1000x470	1200x470	500x380	600x380
Metris															
Metris 100		☉	☉	☉	☉	☉	☉	☉	☉	☉	☉	☉	☉	☉	☉
Metris 110		☉	☉	☉	☉	☉	☉	☉	☉	☉	☉	☉	☉	☉	☉
Metris 200		☉	☉	☉	☉	☉	☉	☉	☉	☉	☉	☉	☉	☉	☉
Metris 230		☉	☉	☉	☉	☉	☉	☉	☉	☉	☉	☉	☉	☉	☉
Metris 240		☉	☉	☉	☉	☉	☉	☉	☉	☉	☉	☉	☉	☉	☉
Metris 165mm		☉	☉	☉	☉	☉	☉	☉	☉	☉	☉	☉	☉	☉	☉
Metris 225mm		☉	☉	☉	☉	☉	☉	☉	☉	☉	☉	☉	☉	☉	☉

☑ = Kombination empfohlen | ☉ = Hahnloch durchgestochen | ○ = Hahnloch vorgestochen | ⊙ = ohne Hahnloch

Legende

☉ a1 = 35mm
a2 = 50mm
a3 = 100mm

☉ b1 = 60mm
b2 = 100mm

☉ c1 = 150mm
c2 = 220mm

☉ d1 = 35mm
d2 = 60mm
d3 = 100mm

☉ e1 = 35mm
e2 = 60mm
e3 = 100mm

Montagemasse für verschiedene Einbausituationen

Geprüfte, empfohlene Kombinationen

Erläuterungen Waschbeckentyp

Lesezeichen

- Einleitung
- Duravit 2nd Floor
- Duravit New Darling
- Duravit Starck 3
- Duravit Vero

Mit dem angelegten **Inhaltsverzeichnis** gelangen Sie einfach zur gewünschten Keramiklinie.

Suchen

Wenn Sie nach einer bestimmten Artikelnummer oder einem Produktamen von Armatur oder Waschbecken suchen, nutzen Sie das **Suchfeld** (Tastenkombination: Strg+f). So finden Sie schnell das gewünschte Produkt.

Welche Hansgrohe Armatur passt zu welchem Waschbecken?

Burgbad

	Bel						
		610 x 355		1210 x 487	1610 x 487	710 x 405	910 x 405
		● #MWAU061 #MWAU081	○ #MWAU061* #MWAU081*	●	●	●	○ #MWAU071* #MWAU091
Metris Classic							
Metris Classic 100 #31075000	✓		✓	✓	✓	✓	
Metris Classic 250 #31078000			✓	✓			
Metris Classic 165 mm #31000000		✓c1			✓c1	✓c1	
Metris Classic 225 mm #31003000					✓c1	✓c1	

Burgbad

	Cala								
		605 x 550		905 x 550	1205 x 550	1505 x 550			
		● #WTU060M	● #WTU099M #WTU096A	○ #WTU099M* #WTU096A*	● #WTU120M #WTU122M #WTU123A	○ #WTU120M* #WTU122M* #WTU123A*	● #WTU150M	○ #WTU150M*	
Metris Classic									
Metris Classic 100 #31075000	✓	✓		✓		✓			
Metris Classic 250 #31078000	✓	✓		✓		✓			
Metris Classic 165 mm #31000000			✓c1		✓c1	✓c1			



Legende

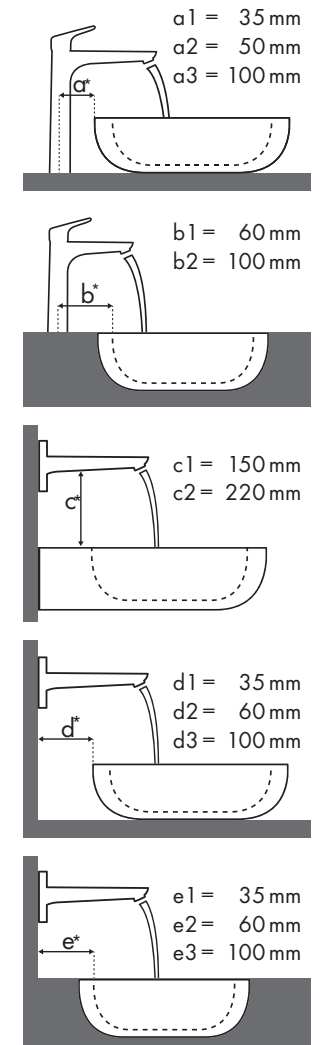







* = Waschbecken ohne Hahnloch auf Anfrage



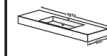
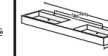



✓ = Kombination empfohlen | ● = Hahnloch durchgestochen | ○ = Hahnloch vorgestochen | ⊗ = ohne Hahnloch

Welche Hansgrohe Armatur passt zu welchem Waschbecken?

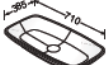



Burgbad

Crono 1.0							
		810 x 500	1210 x 500	1610 x 500	2010 x 500		
		●	⊗	●	⊗	●	⊗
Metris Classic		# MES8065	# MES8065*	# MES1265 # MES1266	# MES1265* # MES1266*	# MES1665 # MES1665*	# MDS2065 # MDS2065
Metris Classic 100 	# 31075000	✓	✓	✓	✓	✓	✓
Metris Classic 250 	# 31078000	✓	✓	✓	✓	✓	✓
Metris Classic 225mm 	# 31003000	✓c1	✓c1	✓c1	✓c1	✓c1	✓c1

Burgbad

Max 1			
		710 x 385	906 x 506
		⊗	●
Metris Classic		# KBAF070 # SELT070	# KBAC091 # SELR091 # KBAD091 # SELS091
Metris Classic 100 	# 31075000		✓
Metris Classic 250 	# 31078000	✓a3	✓
Metris Classic 165 mm 	# 31000000	✓c1 ✓d2	
Metris Classic 225 mm 	# 31003000	✓c1 ✓d3	

Burgbad

Sinea		
		1210 x 490
		●
Metris Classic		# WTU121E # WTU121E*
Metris Classic 100 	# 3075000	✓
Metris Classic 165 mm 	# 31000000	✓c1
Metris Classic 225 mm 	# 31003000	✓c1





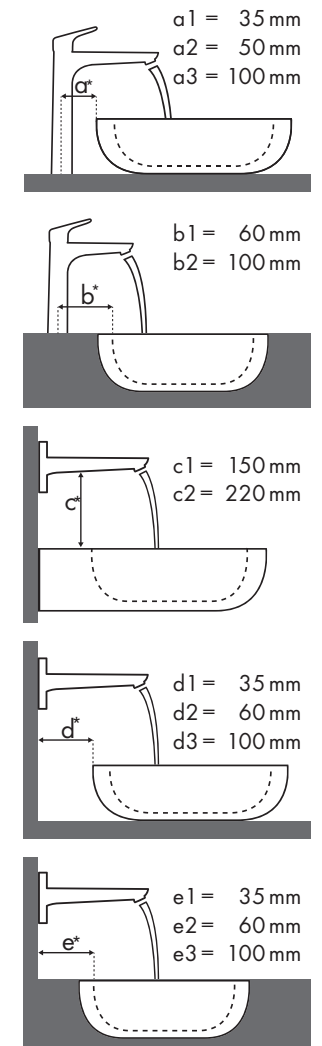





Legende

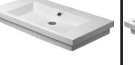

Welche Hansgrohe Armatur passt zu welchem Waschbecken?

Duravit

2nd Floor										
		400 x 300	525 x 350	600 x 430		800 x 500		1200 x 505	580 x 415	
		●	⊗	●	⊗	●	⊗	●	⊗	
Metris Classic		# 079040..00	# 031653..00	# 049160..00 # 049160..27	# 049160..60 # 049160..28	# 049180..00 # 049180..27	# 049180..60 # 049180..28	# 049112..00 # 049112..27	# 049112..60 # 049112..28	# 031758..00 # 031758..29
	Metris Classic 100 # 31075000	✓	✓ ^{b1}	✓		✓		✓		
	# 31077000	✓	✓ ^{b1}					✓		
	Metris Classic 250 # 31078000					✓		✓		✓ ^{a1}
	Metris Classic 165 mm # 31000000		✓ ^{c1} ✓ ^{e2}		✓ ^{c1}		✓ ^{c1}		✓ ^{c1}	✓ ^{d1}
	Metris Classic 225 mm # 31003000		✓ ^{c1} ✓ ^{e2}		✓ ^{c1}		✓ ^{c1}		✓ ^{c1}	✓ ^{d2}





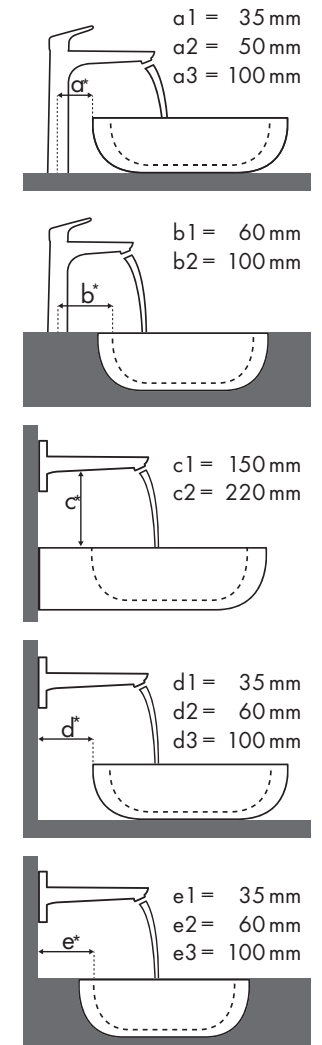





Legende



Welche Hansgrohe Armatur passt zu welchem Waschbecken?

Duravit

DuraStyle					
		370x370	430x430	600x380	1000x480
		⊗	⊗	⊗	●
Metris Classic		# 037337.00	# 034943.00	# 034960.00	# 232010.00
Metris Classic 100 	# 31075000	✓ ^{b1}			✓
	# 31077000	✓ ^{b1}			✓
Metris Classic 250 	# 31078000	✓ ^{b2}			✓
Metris Classic 165 mm 	# 31000000	✓ ^{c1} e1	✓ ^{c1} d1	✓ ^{c1} d1	
Metris Classic 225 mm 	# 31003000	✓ ^{c1} e2	✓ ^{c1} d2	✓ ^{c1} d3	





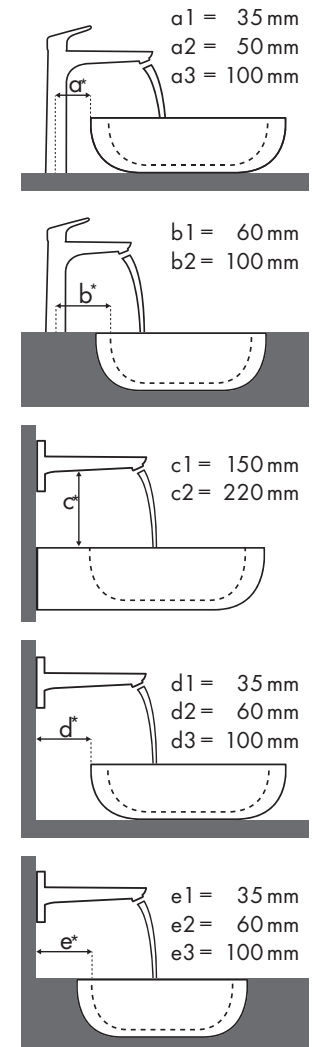

Legende



Welche Hansgrohe Armatur passt zu welchem Waschbecken?

Duravit

Happy D.2						
		500 x 360	600 x 500	600 x 400	600 x 460	1000 x 505
		●	●	⊗	⊗	●
		# 070950..00	# 231660..00	# 231460..00	# 231560..00	# 231810..00
Metris Classic						
Metris Classic 100	# 31075000	✓	✓		✓	✓
	# 31077000	✓	✓		✓	✓
Metris Classic 250	# 31078000			✓ ^{a2}		✓
	# 31000000			✓ ^{c1} _{d1}		
Metris Classic 225 mm	# 31003000			✓ ^{c1} _{d2}		





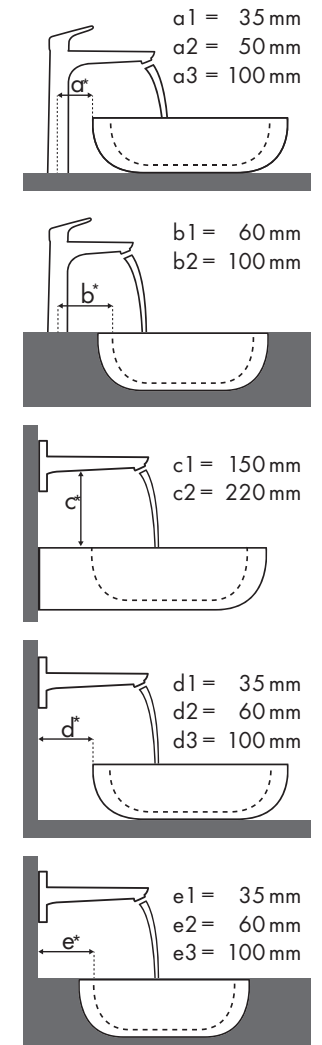





Legende

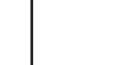

Welche Hansgrohe Armatur passt zu welchem Waschbecken?

Duravit

New Darling							
		470 x 345	600 x 520	650 x 540	470 x 470	830 x 545	1030 x 545
		● # 073147..00	● # 262160..00	● # 262165..00	● # 049747..00	● # 049983..00	● # 049910..00
Metris Classic							
Metris Classic 100 	#31075000	✓	✓	✓	✓	✓	✓
	#31077000	✓	✓	✓	✓	✓	✓
Metris Classic 250 	#31078000					✓	✓





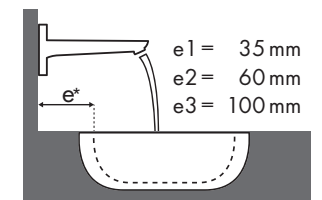
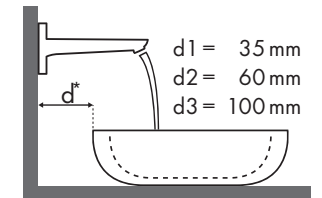
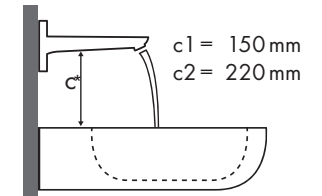
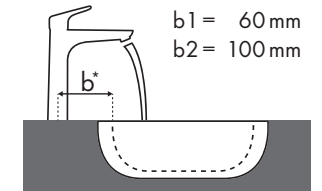
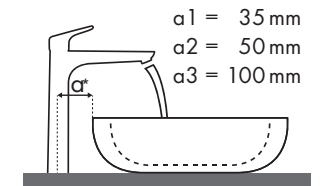

Legende



Welche Hansgrohe Armatur passt zu welchem Waschbecken?

Duravit

Starck 3							
		500 x 260	490 x 365	650 x 485	700 x 490	850 x 485	1050 x 485
		○ # 075150..00	● # 030249..00 # 030256..00	● # 030065..00	● # 030470..00	● # 030480..00	● # 030410..00
Metris Classic							
Metris Classic 100	# 31075000	✓	✓	✓	✓	✓	✓
	# 31077000	✓	✓	✓	✓	✓	✓
Metris Classic 250	# 31078000			✓	✓	✓	✓



Legende

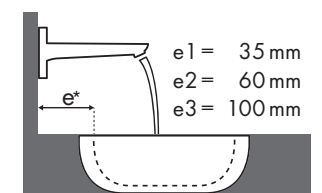
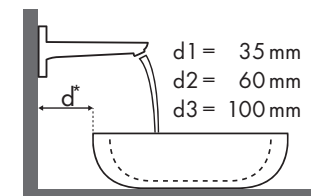
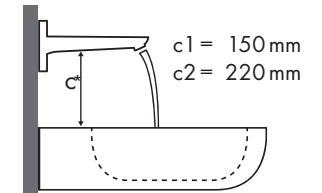
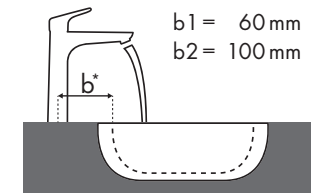
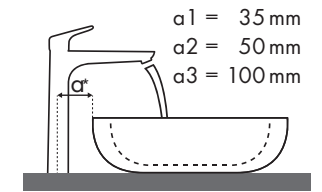

Welche Hansgrohe Armatur passt zu welchem Waschbecken?

Duravit

Vero																											
		595 x 465		550 x 465		850 x 490		1050 x 490		1250 x 490		600 x 470			800 x 470		1000 x 470		1200 x 470		500 x 380	600 x 380					
		●	⊗	●	⊗	●	⊗	●	⊗	●	⊗	●	⊗	●	⊗	●	⊗	●	⊗	●	⊗	●	⊗				
Metris Classic		# 045260..00	# 045260..60	# 031555..00	# 031555..60	# 032985..00	# 032985..60	# 032910..00	# 032910..60	# 032912..00	# 032912..60	# 045460..00	# 045460..27	# 045460..60	# 045460..28	# 045460..41	# 045460..70	# 045480..00	# 045480..27	# 045480..60	# 045480..28	# 045410..27	# 045410..28	# 045412..00	# 045412..60	# 045550..00	# 045560..00
Metris Classic 100	# 31075000	✓		✓		✓		✓		✓		✓						✓		✓		✓					
	# 31077000	✓		✓		✓		✓		✓		✓		✓		✓		✓		✓		✓					
Metris Classic 250	# 31078000	✓		✓		✓		✓		✓		✓						✓		✓							
Metris Classic 165 mm	# 31000000		✓ ^{c1}		✓ ^{c1}																					✓ ^{c1} _{d1}	✓ ^{c1} _{d1}
Metris Classic 225 mm	# 31003000		✓ ^{c1}		✓ ^{c1}		✓ ^{c1}		✓ ^{c1}		✓ ^{c1}		✓ ^{c1}		✓ ^{c1}		✓ ^{c1}		✓ ^{c1}		✓ ^{c1}		✓ ^{c1}		✓ ^{c1}	✓ ^{c1} _{d3}	✓ ^{c1} _{d3}





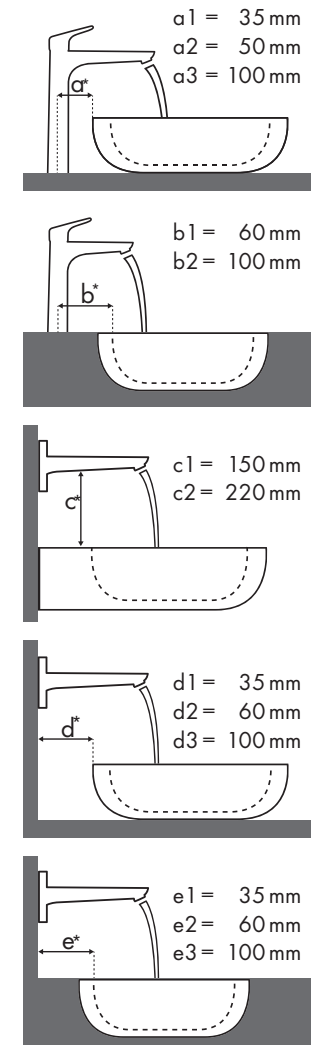





Legende



Welche Hansgrohe Armatur passt zu welchem Waschbecken?

Gala

						
		600 x 450	600 x 475	800 x 475	800 x 475	800 x 475
		●	●	●	●	●
Metris Classic		# 2701001..00	# 1302001..00	# 1301001..00	# 2605001..00	# 2604001..00
 Metris Classic 100	# 31075000	✓			✓	✓
	# 31077000	✓	✓	✓	✓	✓
 Metris Classic 250	# 31078000				✓	✓
	# 31000000				✓	✓
 Metris Classic 165 mm	# 31000000				✓	✓





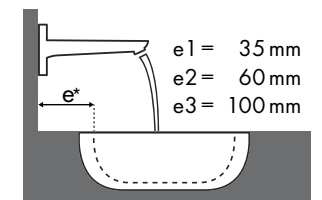
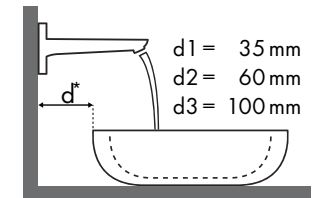
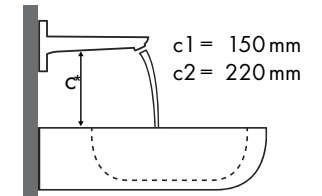
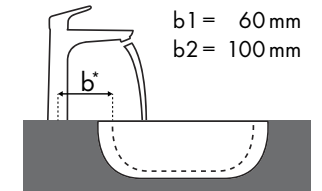
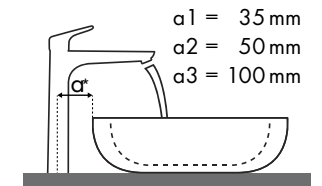



Legende



Welche Hansgrohe Armatur passt zu welchem Waschbecken?

Ideal Standard

SimplyU				
		500 x 500	500 x 650	550 x 350
		● # T0997 xx	● # T0156 xx	○ # T0129 xx
Metris Classic 100 	#31075000	✓	✓	
Metris Classic 165 mm 	#31000000		✓ c1	✓ d1 ^{c1}
Metris Classic 225 mm 	#31003000		✓ c1	✓ d3 ^{c1}





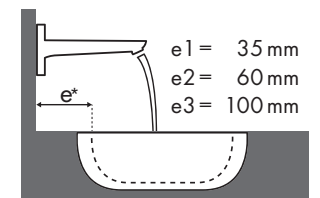
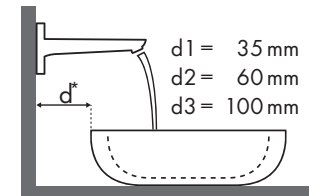
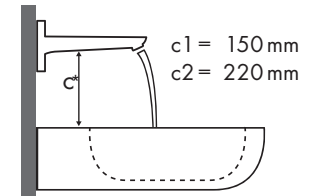
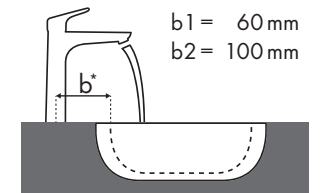
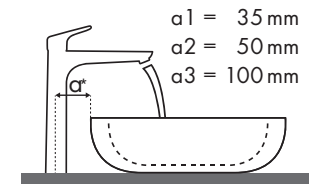





Legende



Welche Hansgrohe Armatur passt zu welchem Waschbecken?

Laufen

My Life									
		470 x 380		750 x 480		750 x 530		650 x 440	
		●	⊗	●	⊗	●	⊗	●	⊗
Metris Classic		#815942/104	#815942/109	#811946/104	#811946/109	#810946/104	#810946/109	#818944/104	#818944/109
Metris Classic 100 	#31075000			✓		✓		✓	
	#31077000	✓							
Metris Classic 250 	#31078000			✓ ^{a2}		✓			✓ ^{a2}
Metris Classic 165 mm 	#31000000		✓ ^{c1}		✓ ^{d1}				✓ ^{d1}
Metris Classic 225 mm 	#31003000		✓ ^{c1}		✓ ^{d1}		✓ ^{c1}		✓ ^{d2}





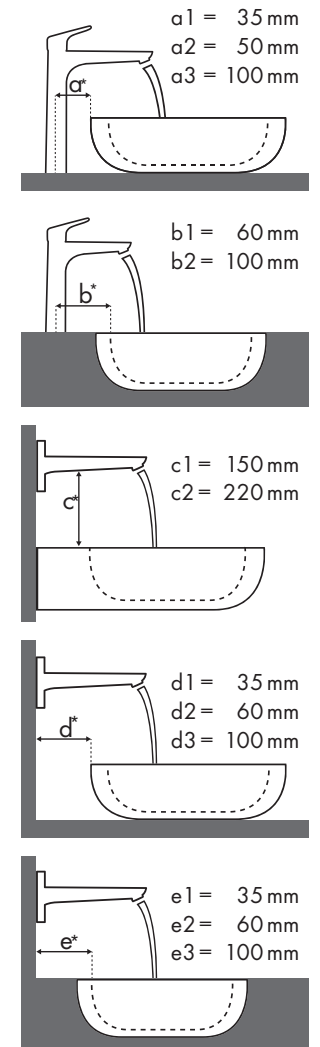





Legende



Welche Hansgrohe Armatur passt zu welchem Waschbecken?

Laufen

Pro												
		450 x 340		525 x 400	625 x 400	600 x 380		850 x 480	1050 x 480		600 x 400	
		● #811951/104 ○ #811952/104	● #811951/156 ○ #811951/109 ○ #811952/109	○ #811951/142	○ #811961/109 ○ #811961/155	○ #811969/109 ○ #811969/155	● #812953/104 ● #812953/156 ○ #812953/109 ○ #812953/142	● #813956/104 ○ #813956/109	● #813958/104 ○ #813958/109	○ #816952/112		
Metris Classic												
	#31075000	✓			✓ ^{b1}	✓ ^{b1}	✓			✓		
	#31077000	✓	✓		✓ ^{b1}	✓ ^{b1}	✓	✓		✓		
	#31078000				✓ ^{b1}	✓ ^{b1}				✓		✓ ^{a2}
	#31000000		✓ ^{c1}	✓ ^{c1}	✓ ^{c1} _{e2}	✓ ^{c1} _{e2}		✓ ^{c1}	✓ ^{c1}	✓ ^{c1}	✓ ^{c1}	✓ ^{c1} _{d2}
	#31003000		✓ ^{c1}	✓ ^{c1}	✓ ^{c1} _{e2}	✓ ^{c1} _{e2}		✓ ^{c1}	✓ ^{c1}	✓ ^{c1}	✓ ^{c1}	✓ ^{c1} _{d2}





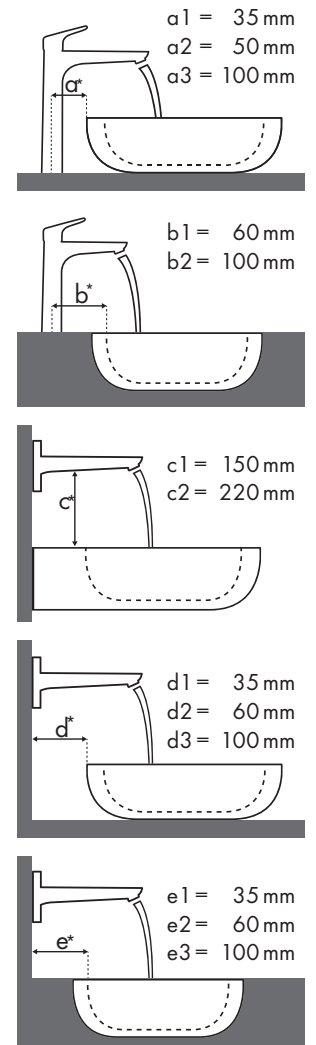









Legende



✓ = Kombination empfohlen | ● = Hahnloch durchgestochen | ○ = Hahnloch vorgestochen | ⊗ = ohne Hahnloch

Welche Hansgrohe Armatur passt zu welchem Waschbecken?

Roca

											
		Java 560 x 475	Selene 510 x 395	Meridian 850 x 460	Diverta 470 x 440	Diverta 750 x 440	Ibis 440 x 310	Victoria 560 x 460	Victoria 650 x 510	The Gap 600 x 470	The Gap 650 x 470
Metris Classic		● # 7327863000	⊗ # 7322307000	● # 32724D0000	● # 73271110	● # 3271100000	○ # 3208410010	● # 3253930000	● # 3253910000	● # 3274740000	● # 3274730000
Metris Classic 100 	# 31075000	✓		✓	✓	✓	✓	✓	✓	✓	✓
	# 31077000	✓		✓	✓	✓	✓	✓	✓	✓	✓
Metris Classic 250 	# 31078000	✓	✓ ^{a2}					✓	✓		
Metris Classic 165mm 	# 31000000						✓ ^{c1}				





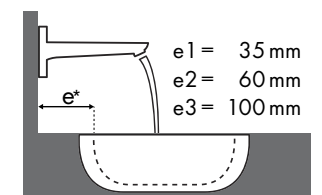
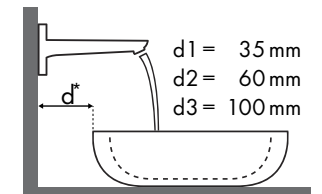
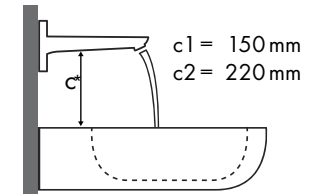
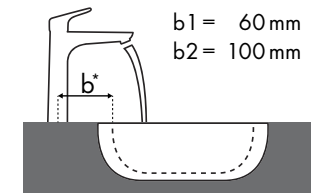
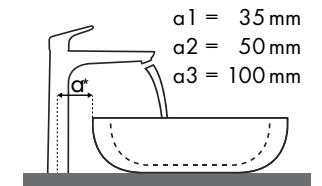





Legende



Welche Hansgrohe Armatur passt zu welchem Waschbecken?

Villeroy & Boch

Memento														
		400 x 260	500 x 420				600 x 420				800 x 470			
		● # 5333 41 XX ● # 5333 4G XX	● # 5133 50 XX ● # 5133 5L XX	● # 5133 51 XX ● # 5133 5G XX	⊗ # 5133 52 XX ⊗ # 5133 5J XX	⊗ # 5133 53 XX ⊗ # 5133 5F XX	● # 5133 60 XX ● # 5133 6L XX	● # 5133 61 XX ● # 5133 6G XX	⊗ # 5133 62 XX ⊗ # 5133 6J XX	⊗ # 5133 63 XX ⊗ # 5133 6F XX	● # 5135 60 XX ● # 5135 61 XX	⊗ # 5135 62 XX ⊗ # 5135 63 XX	● # 5133 85 XX ● # 5133 81 XX	⊗ # 5133 86 XX ⊗ # 5133 83 XX
Metris Classic														
	# 31075000		✓			✓				✓		✓		
	# 31077000	✓	✓	✓		✓	✓			✓	✓			
	# 31078000											✓		
	# 31000000				✓ ^{c1}	✓ ^{c1}			✓ ^{c1}	✓ ^{c1}		✓ ^{c1}	✓ ^{c1}	
	# 31003000				✓ ^{c1}	✓ ^{c1}			✓ ^{c1}	✓ ^{c1}		✓ ^{c1}	✓ ^{c1}	





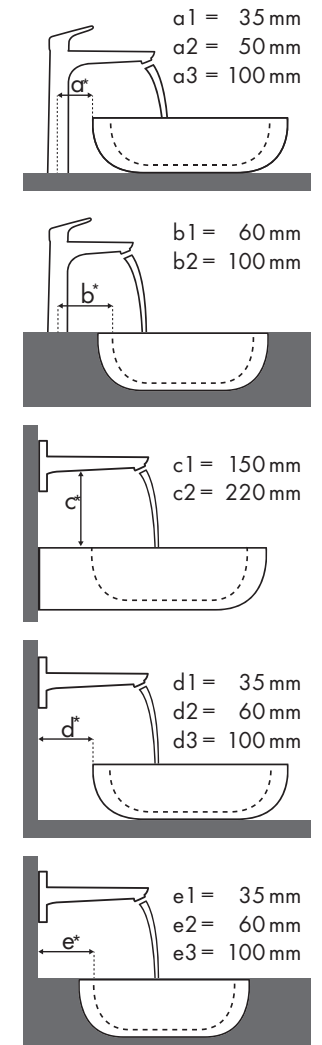

Legende











✓ = Kombination empfohlen | ● = Hahnloch durchgestochen | ○ = Hahnloch vorgestochen | ⊗ = ohne Hahnloch

Welche Hansgrohe Armatur passt zu welchem Waschbecken?

Villeroy & Boch

		Sentique				
						
		450 x 360	650 x 500	555 x 450		
		●	●	●	●	●
		# 5322 45 XX	# 5322 46 XX	# 5143 65 XX	# 5143 66 XX	# 5146 55 XX
Metris Classic						
	# 31075000	✓		✓		✓
	# 31077000	✓	✓	✓	✓	✓

Villeroy & Boch

		Subway 2.0								
										
		450 x 370	500 x 400	600 x 470	650 x 490	630 x 355				
		●	●	●	●	●	●	●	●	●
		# 7315 45 XX	# 7315 50 XX	# 7113 60 XX	# 7113 61 XX	# 7113 62 XX ⊗	# 7114 65 XX	# 7114 66 XX	# 7114 67 XX ⊗	# 4115 6R XX # 4115 6R XX
Metris Classic										
	# 31075000	✓	✓	✓			✓			
	# 31077000	✓	✓	✓	✓		✓	✓		✓
	# 31000000							✓ ^{c1}		
	# 31003000					✓ ^{c1}		✓ ^{c1}		





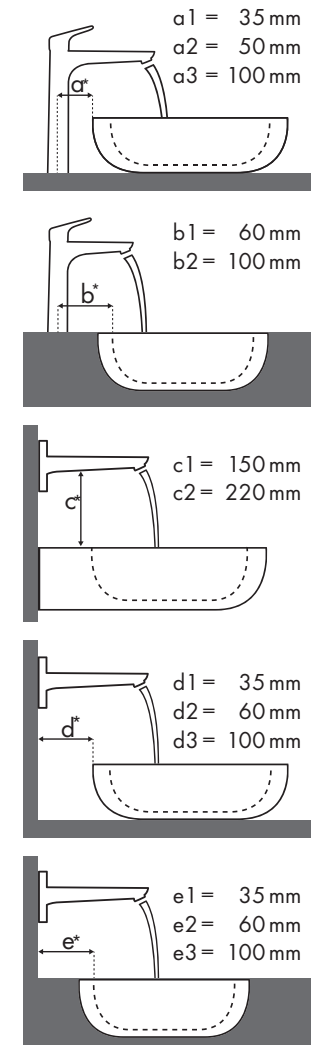











Legende



Welche Hansgrohe Armatur passt zu welchem Waschbecken?

Villeroy & Boch

Loop & Friends													
		380 x 380		405 x 405		430 x 430		450 x 450		450 x 320		585 x 380	
		⊗	⊗	⊗	⊗	⊗	⊗	⊗	⊗	⊗	⊗	⊗	⊗
Metris Classic		# 5149 00 XX	# 5149 01 XX	# 6156 10 XX	# 6156 11 XX	# 5144 00 XX	# 5144 01 XX	# 6140 45 XX	# 6141 45 XX	# 6155 00 XX	# 6155 01 XX	# 5151 00 XX	# 5151 01 XX
Metris Classic 100	# 31075000			✓a1									
	# 31077000				✓a1								
Metris Classic 250	# 31078000	✓a2		✓a2		✓a2		✓a2				✓a2	
													
Metris Classic 165 mm	# 31000000	✓c1 d2	✓c1 d2	✓c1 d2	✓c1 d2			✓c1 d2	✓c1 d2	✓c1 d2	✓c1 d2	✓c1 d1	✓c1 d1
													
Metris Classic 225 mm	# 31003000	✓c1 d3	✓c1 d3	✓c1 d2	✓c1 d2	✓c1 d3	✓c1 d3	✓c1 d2	✓c1 d2	✓c1 d2	✓c1 d2		
													

Loop & Friends									
		380 x 380		430 x 430		450 x 450		585 x 380	
		⊗	⊗	⊗	⊗	⊗	⊗	⊗	⊗
Talis Classic		# 5149 00 XX	# 5144 00 XX	# 6140 45 XX	# 5151 00 XX				
Talis Classic 230	# 14116000	✓a2	✓a2	✓a2	✓a2				
									



Legende

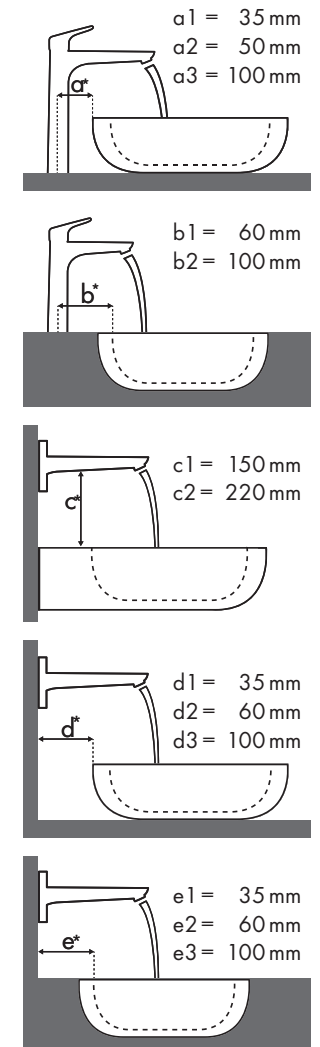

✓ = Kombination empfohlen | ● = Hahnloch durchgestochen | ○ = Hahnloch vorgestochen | ⊗ = ohne Hahnloch