

汉斯格雅舒适空间测试

适合每款面盆的龙头。满足顾客的需求。



由于龙头与面盆的不匹配而导致令人讨厌的溅水问题也许您已经经历过这种情况。现在这种问题已经成为历史。



汉斯格雅将当今主要面盆制造商所生产的一些最受欢迎的产品的都进行了舒适空间的测试，这是专门为完美搭配龙头与面盆解决溅水问题而开发出来的测试程序。在该测试中，我们测试了龙头出水嘴距离面盆之间的空间以及各种溅水状况。想要了解更多信息，您可以登录我们的网站：

www.pro.hansgrohe.com.cn/comfortzone-test

面盆种类

对于市场上绝大多数面盆，您都能找到与之相配的汉斯格雅龙头。汉斯格雅舒适空间测试是让龙头与面盆完美搭配安装并避免溅水问题的一个综合性的参考指导。我们在舒适空间测试中测试了五种不同的面盆款式：

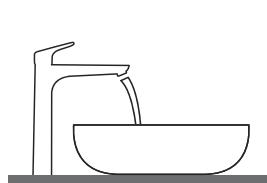

面盆和装在面盆后方的龙头

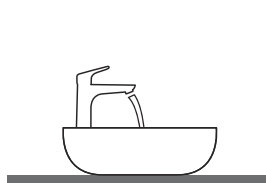

面盆和装在面盆上的龙头

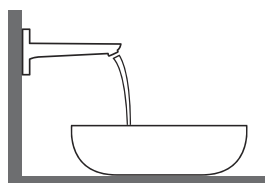

面盆和装在墙上的龙头

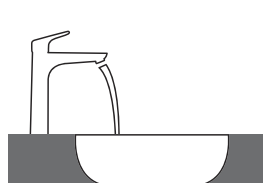

台下盆或台上盆和独立式龙头

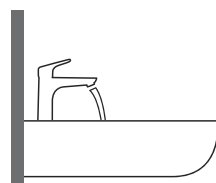

挂盆和装在挂盆上的龙头

您现在可以登录我们的网站，免费得到舒适空间的测试结果：www.pro.hansgrohe.com.cn/comfortzone-test

指导

以下内容显示了运用舒适空间的测试结果是多么的容易。

汉斯格雅舒适空间龙头和型号 (不同的型号代表不同的落水配置)

面盆生产商和面盆产品

面盆及其型号和尺寸细节 (不同的型号代表不同的龙头安装孔和溢水版本)

Testergebnisse mit Duravit Waschbecken_EN.pdf - Adobe Acrobat Pro

hansgrohe

Which Hansgrohe mixer suits which basin?

Duravit		Vero	250x450	500x250	485x315	595x465	550x465	850x490	1050x490	1250x490	600x470	800x470	1000x470	1200x470	500x380	600x390
			● #070235.00	● #070350.08 ● #070350.07 ○ #070350.00	● #030408.00 ● #030408.24	● #045360.00	● #031555.00	● #032985.00	● #032910.00	● #032912.00	● #045460.00 ● #045460.27 ● #045460.41	● #045480.00 ● #045480.27	● #045410.27	● #045412.00	● #045450.00	● #045550.00
Metris 100	#31088000	✓	✓													
	#31166000	✓	✓													
Metris 110	#31080000	✓	✓	✓ b1	✓	✓	✓	✓	✓	✓	✓	✓	✓	✓	✓	✓
	#31121000	✓	✓	✓ b1	✓	✓	✓	✓	✓	✓	✓	✓	✓	✓	✓	✓
	#31084000	✓	✓	✓ b1	✓	✓	✓	✓	✓	✓	✓	✓	✓	✓	✓	✓
Metris 200	#31183000			✓ b1	✓	✓	✓	✓	✓	✓	✓	✓	✓	✓	✓	✓
	#31185000			✓ b1	✓	✓	✓	✓	✓	✓	✓	✓	✓	✓	✓	✓
Metris 230	#31087000			✓ b1	✓	✓	✓	✓	✓	✓	✓	✓	✓	✓	✓	✓
	#31187000			✓ b1	✓	✓	✓	✓	✓	✓	✓	✓	✓	✓	✓	✓
Metris 260	#31082000			✓ b2	✓	✓	✓	✓	✓	✓	✓	✓	✓	✓	✓	✓
	#31184000			✓ b2	✓	✓	✓	✓	✓	✓	✓	✓	✓	✓	✓	✓
Metris 165 mm	#31085000			✓ d1	✓	✓	✓	✓	✓	✓	✓	✓	✓	✓ a3	✓ a3	✓
Metris 225 mm	#31086000			✓ c1	✓	✓	✓	✓	✓	✓	✓	✓	✓	✓ c1	✓ c1	✓ d1

Legend

- a1 = 35 mm
- a2 = 50 mm
- a3 = 100 mm
- b1 = 60 mm
- b2 = 100 mm
- c1 = 150 mm
- c2 = 220 mm
- d1 = 35 mm
- d2 = 60 mm
- d3 = 100 mm
- e1 = 35 mm
- e2 = 60 mm
- e3 = 100 mm

安装尺寸适合不同安装情况

经测试的推荐搭配

面盆种类信息

Search

使用搜索栏来搜索龙头或面盆的产品型号或名称 (主要搭配: Ctrl+f)。这是最快找到您产品完美搭配的方法。

✓ = Recommended combination | ● = Taphole pushed through | ○ = Prepared taphole | ⊗ = without taphole







Bookmarks

- Introduction
- Duravit 2nd Floor
- Duravit New Darling
- Duravit Starck 3
- Duravit Vero



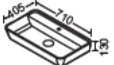



表格内容将让您更加轻松地选择您适合的面盆产品

哪款汉斯格雅龙头适合哪款面盆?

Burgbad

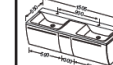
	Bel					
		610x355	1210x487	1610x487	710x405	910x405
		● # MWALU061 # MWALU081 # MWALU081	● # MWAV121	● # MWAV161	● # MWAW071	● # MWAW091
福柯斯						
 福柯斯 100	# 31607000 # 31621000	✓			✓	✓
 福柯斯 190	# 31608000		✓	✓	✓	✓
 福柯斯 240	# 31609000		✓	✓	✓	✓

Burgbad

	Cala				
		605x550	905x550	1205x550	1505x550
		● # WTU060M	● # WTU099M # WTU096A	● # WTU120M # WTU122M # WTU123A	● # WTU150M
福柯斯					
 福柯斯 70	# 31730000	✓			✓
 福柯斯 100	# 31607000 # 31621000	✓	✓	✓	✓
 福柯斯 190	# 31608000	✓	✓	✓	✓
 福柯斯 240	# 31609000	✓	✓	✓	✓





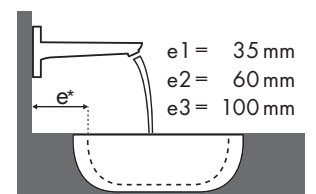
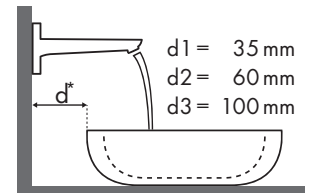
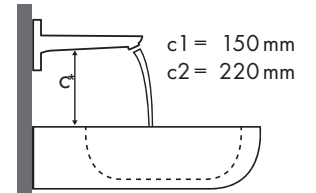
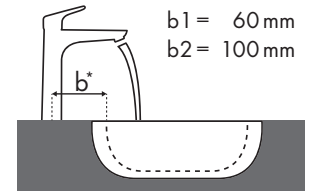
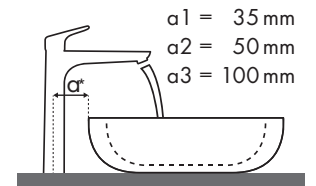



图例



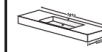



哪款汉斯格雅龙头适合哪款面盆?





Burgbad

Crono 1.0					
		810 x 500	1210 x 500	1610 x 500	2010 x 500
		●	●	●	●
		# MES8065	# MES1265 # MES1266	# MES1665	# MDS2065
福柯斯					
福柯斯 100	 # 31607000 # 31621000	✓	✓	✓	✓
福柯斯 190	 # 31608000	✓	✓	✓	✓
福柯斯 240	 # 31609000	✓	✓	✓	✓

Burgbad

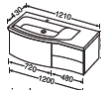
Max 1			
		710 x 385	906 x 506
		⊗	●
		# KBAF070 # SELT070	# KBAC091 # SELR091 # KBAD091 # SELS091
福柯斯			
福柯斯 100	 # 31607000 # 31621000		✓
福柯斯 190	 # 31608000	✓ ^{a2}	✓
福柯斯 240	 # 31609000		✓

Burgbad

Sinea		
		1210 x 490
		●
		# WTU121E
福柯斯		
Focus 70	 # 31730000	✓
Focus 100	 # 31607000 # 31621000	✓
Focus 190	 # 31608000	✓





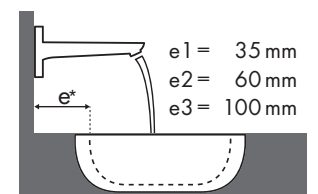
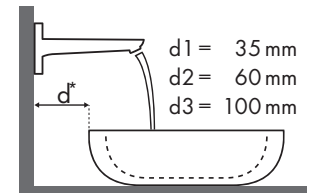
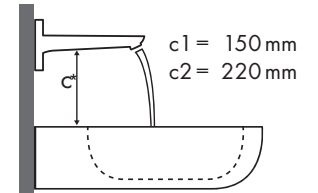
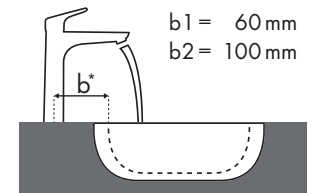
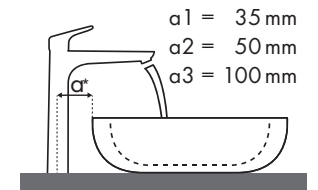



图例



哪款汉斯格雅龙头适合哪款面盆?

Duravit

2nd Floor							
		400 x 300	525 x 350	600 x 430	800 x 500	1200 x 505	580 x 415
		●	⊗	●	●	●	⊗
福柯斯		# 079040..00	# 031653..00	# 049160..00 # 049160..27	# 049180..00 # 049180..27	# 049112..00 # 049112..27	# 031758..00 # 031758..29
福柯斯 100 	# 31607000 # 31621000		✓b1	✓	✓	✓	
	# 31517000	✓	✓b1	✓	✓	✓	
福柯斯 190 	# 31608000		✓b1	✓	✓	✓	
	# 31518000		✓b1	✓	✓	✓	✓a1





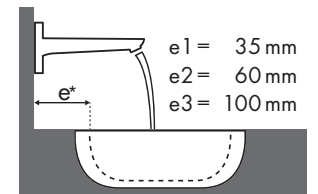
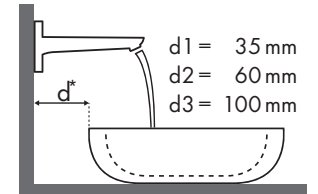
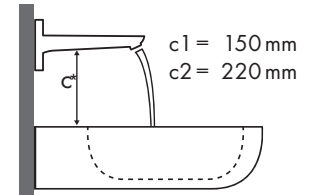
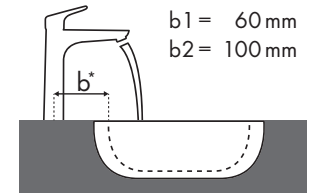
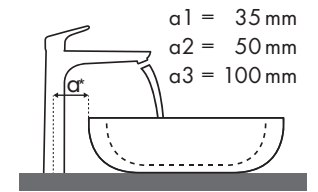





图例



✓ = 建议搭配 | ● = 穿过龙头安装孔 | ○ = 带龙头安装孔 | ⊗ = 没有龙头安装孔

哪款汉斯格雅龙头适合哪款面盆?

Duravit

New Darling								
		470 x 345	600 x 520	650 x 540	470 x 470	830 x 545	1030 x 545	
		● # 073147.00	● # 262160.00	● # 262165.00	● # 049747.00	● # 049983.00	● # 049910.00	
福柯斯								
福柯斯 70 	# 31730000	✓						
	# 31733000	✓						
	# 31130000	✓						
福柯斯 100 	# 31607000		✓	✓	✓	✓	✓	
	# 31621000		✓	✓	✓	✓	✓	
	# 31517000		✓	✓	✓	✓	✓	
福柯斯 190 	# 31608000		✓	✓	✓	✓	✓	
	# 31518000		✓	✓	✓	✓	✓	
福柯斯 240 	# 31609000		✓	✓	✓	✓	✓	
	# 31519000		✓	✓	✓	✓	✓	





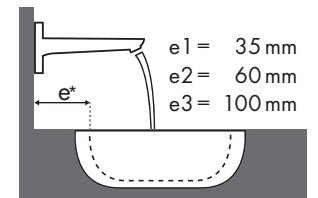
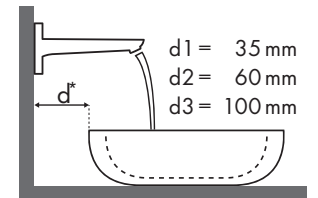
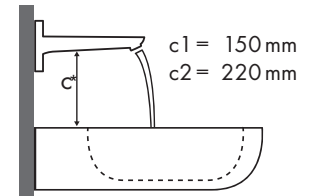
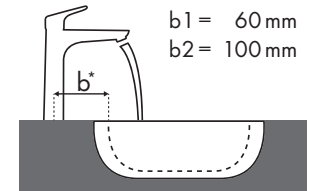
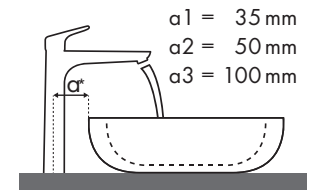





图例



✓ = 建议搭配 | ● = 穿过龙头安装孔 | ○ = 带龙头安装孔 | ⊗ = 没有龙头安装孔

哪款汉斯格雅龙头适合哪款面盆?

Duravit

Starck 3							
		500 x 260	490 x 365	650 x 485	700 x 490	850 x 485	1050 x 485
		○	● ●	●	●	●	●
福柯斯		# 075150.00	# 030249.00 # 030256.00	# 030065.00	# 030470.00	# 030480.00	# 030410.00
福柯斯 70 	# 31730000	✓	✓	✓			
	# 31733000 # 31130000	✓	✓	✓			
	福柯斯 100 	# 31607000 # 31621000	✓	✓	✓	✓	✓
	# 31517000	✓	✓	✓	✓	✓	✓
福柯斯 190 	# 31608000		✓	✓	✓	✓	✓
	# 31518000		✓	✓	✓	✓	✓
福柯斯 240 	# 31609000		✓	✓			
	# 31519000		✓	✓			





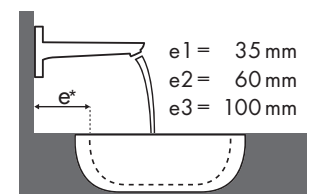
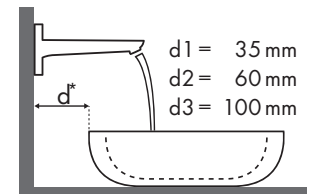
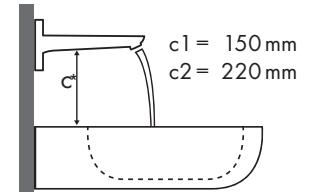
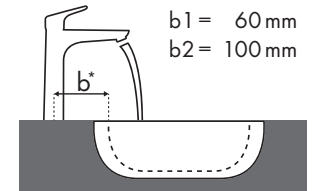
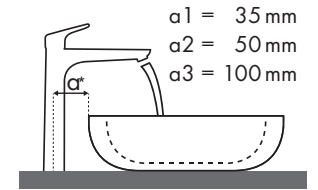







图例

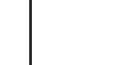

✓ = 建议搭配 | ● = 穿过龙头安装孔 | ○ = 带龙头安装孔 | ⊗ = 没有龙头安装孔

哪款汉斯格雅龙头适合哪款面盆?

Duravit

Vero																		
	250 x 450	500 x 250	485 x 315	595 x 465	550 x 465	850 x 490	1050 x 490	1250 x 490	600 x 470	800 x 470	1000 x 470	1200 x 470	500 x 380	600 x 380				
	● #070225.00	● #070350.08 ● #070350.09	○ #070350.00	⊗ #033048.00 #033048.22	● #045260.00	● #031555.00	● #032985.00	● #032910.00	● #032912.00	● #045460.00 #045460.27	● #045460.41	● #045480.00 #045480.27	● #045410.27	● #045412.00	⊗ #045550.00	⊗ #045560.00		
福柯斯 70 	# 31730000	✓	✓	✓	✓ ^{b1}													
	# 31733000 # 31130000	✓	✓	✓	✓ ^{b1}													
福柯斯 100 	# 31607000 # 31621000				✓ ^{b1}	✓	✓	✓	✓	✓	✓	✓	✓					
	# 31517000				✓ ^{b1}	✓	✓	✓	✓	✓	✓	✓	✓					
福柯斯 190 	# 31608000				✓ ^{b1}	✓	✓	✓	✓	✓	✓	✓	✓					
	# 31518000				✓ ^{b1}	✓	✓	✓	✓	✓	✓	✓	✓	✓ ^{a1}	✓ ^{a1}			
福柯斯 240 	# 31609000							✓	✓	✓			✓	✓				
	# 31519000							✓	✓	✓			✓	✓				



图例

a1 = 35 mm
a2 = 50 mm
a3 = 100 mm

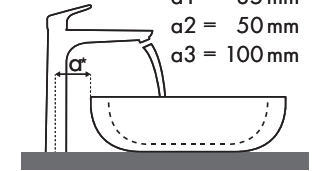

b1 = 60 mm
b2 = 100 mm

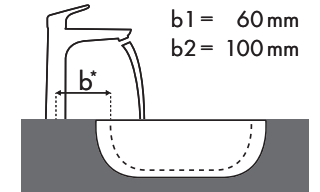

c1 = 150 mm
c2 = 220 mm

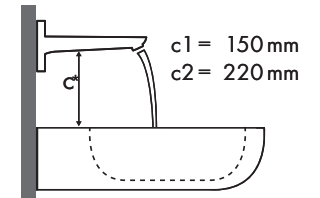

d1 = 35 mm
d2 = 60 mm
d3 = 100 mm

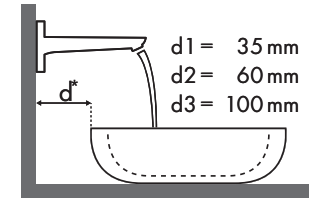

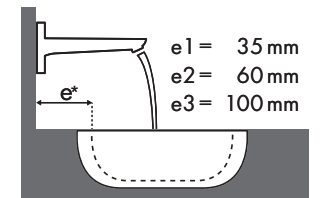

e1 = 35 mm
e2 = 60 mm
e3 = 100 mm





✓ = 建议搭配 | ● = 穿过龙头安装孔 | ○ = 带龙头安装孔 | ⊗ = 没有龙头安装孔

哪款汉斯格雅龙头适合哪款面盆?

Ideal Standard

Moments				
		500 x 375	650 x 515	900 x 515
		●	●	●
福柯斯		# K 0718 xx	# K 0717 xx	# K 0715 xx
福柯斯 70	# 31730000 # 31132000 # 31130000	✓		
福柯斯 100	# 31607000 # 31621000	✓	✓	✓
福柯斯 190	# 31608000		✓	✓
福柯斯 240	# 31609000		✓	✓

Ideal Standard

SimplyU						
		500 x 500	500 x 650	550 x 350		
		●	○	●	○	⊗
福柯斯		# T 0997 xx	# T 0127 xx	# T 0156 xx	# T 0129 xx	# T 0126 xx
福柯斯 70	# 31730000	✓	✓	✓	✓	
福柯斯 100	# 31607000 # 31621000	✓	✓	✓	✓	
福柯斯 190	# 31608000	✓	✓	✓	✓	✓ ^{a2}





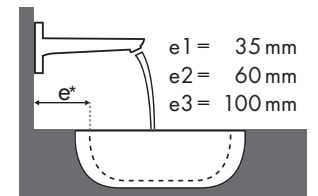
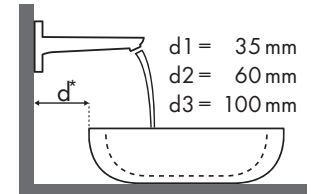
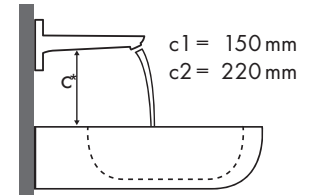
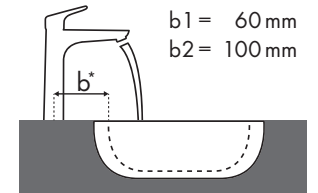
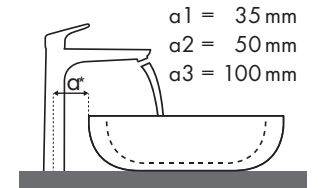

图例











哪款汉斯格雅龙头适合哪款面盆?

Keramag

iCon						
		500 x 485	600 x 485	750 x 485	900 x 485	
福柯斯		●	●	●	●	
		# 124050 # 124150	# 124060	# 124075	# 124090 # 124190 # 124195	
	福柯斯 100	# 31607000 # 31621000	✓	✓	✓	✓
		# 31517000	✓	✓	✓	✓
	福柯斯 190	# 31608000		✓	✓	✓
		# 31518000		✓	✓	✓
	福柯斯 240	# 31609000		✓	✓	✓
		# 31519000		✓	✓	✓

Keramag

Silk					
		400 x 295	600 x 470	570 x 427	1000 x 470
福柯斯		●	●	●	●
		# 121640	# 121660	# 121650 # 121655	# 121600
	福柯斯 70	# 31733000 # 31130000	✓		✓
	福柯斯 100	# 31607000 # 31621000			✓
		# 31517000	✓	✓	✓
	福柯斯 190	# 31608000			✓
		# 31518000		✓	✓
	福柯斯 240	# 31609000			✓
		# 31519000			✓





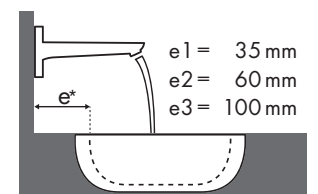
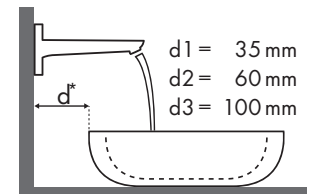
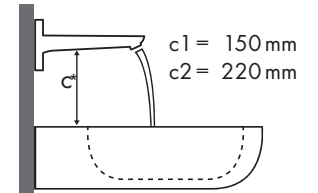
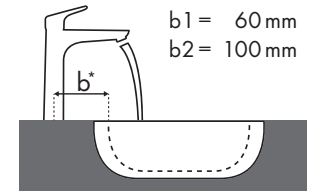
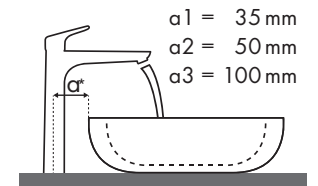



图例



哪款汉斯格雅龙头适合哪款面盆?

Keramag

Renova Nr. 1 Plan														
		600 x 480		650 x 480		750 x 480	600 x 480	650 x 480	850 x 480	1000 x 480	850 x 480		1000 x 480	
		●	●	●	●	●	●	●	●	●	●	●	●	●
福柯斯		# 222260	# 222262	# 222265	# 222267	# 122175 # 122180	# 225160	# 225165	# 125185	# 125100	# 122185	# 122187	# 122100	# 122102
	# 31607000	✓		✓		✓	✓	✓	✓	✓			✓	
	# 31621000													
	# 31517000	✓	✓	✓	✓	✓	✓	✓	✓	✓	✓	✓	✓	✓
	# 31608000	✓		✓		✓	✓	✓	✓	✓			✓	
	# 31518000	✓	✓	✓	✓	✓	✓	✓	✓	✓	✓	✓	✓	✓
	# 31609000	✓		✓		✓	✓	✓	✓	✓			✓	
	# 31519000	✓	✓	✓	✓	✓	✓	✓	✓	✓	✓	✓	✓	✓



图例

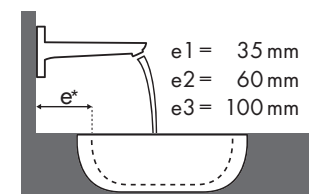
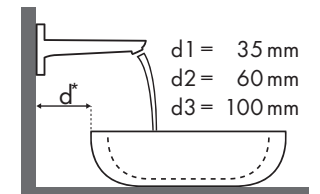
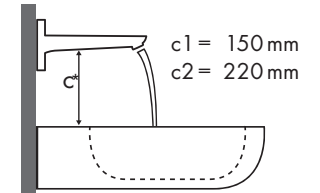
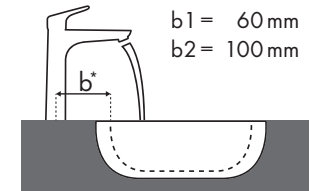
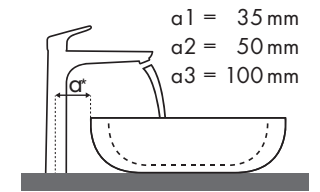

✓ = 建议搭配 | ● = 穿过龙头安装孔 | ○ = 带龙头安装孔 | ⊗ = 没有龙头安装孔

哪款汉斯格雅龙头适合哪款面盆?

Keramag

Xeno		400 x 230		600 x 475	600 x 475	1200 x 475	1200 x 475
		●	●	●	●	●	●
		#126240	#126245	#126260	#126560	#126220	#126225
Focus							
福柯斯 100	#31517000	✓	✓	✓	✓	✓	✓
福柯斯 190	#31518000			✓	✓	✓	✓
福柯斯 240	#31519000			✓	✓	✓	✓

Keramag

My Day		400 x 280		650 x 480	800 x 480	1000 x 480	600 x 400
		●	●	●	●	●	●
		#125540	#125440	#125465	#125480	#125400	#245460
Focus							
福柯斯 100	#31607000	✓	✓	✓	✓	✓	
	#31621000						
	#31517000	✓	✓	✓	✓	✓	
福柯斯 190	#31608000			✓	✓	✓	✓a2
	#31518000			✓	✓	✓	✓a2





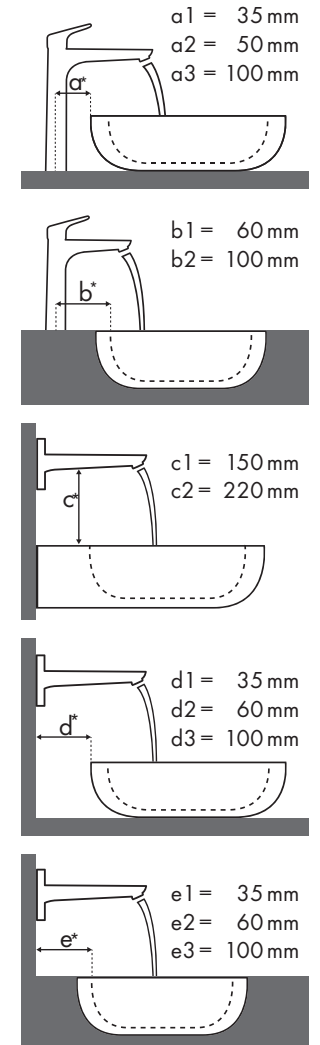





图例



哪款汉斯格雅龙头适合哪款面盆?

Laufen

My Life					
		470 x 380	750 x 480	750 x 530	650 x 440
		● #815942/104	● #811946/104	● #810946/104	● #818944/104
福柯斯					
福柯斯 70 	# 31730000	✓			
福柯斯 100 	# 31607000 # 31621000	✓	✓	✓	✓
福柯斯 190 	# 31608000	✓	✓	✓	✓
福柯斯 240 	# 31609000			✓	✓





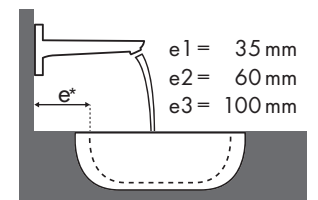
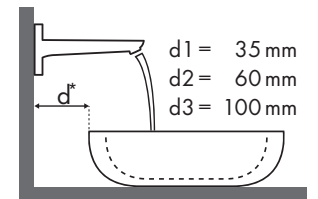
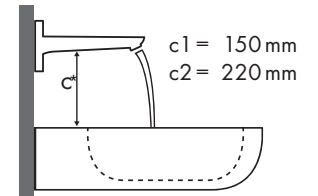
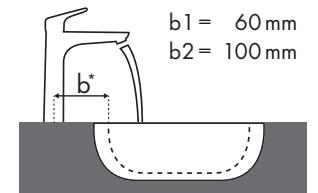
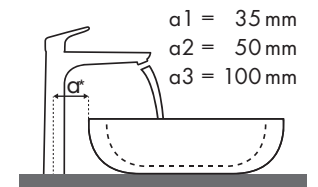





图例



✓ = 建议搭配 | ● = 穿过龙头安装孔 | ○ = 带龙头安装孔 | ⊗ = 没有龙头安装孔

哪款汉斯格雅龙头适合哪款面盆?

Laufen

Pro									
	450 x 340		525 x 400	625 x 400	600 x 380		850 x 480	1050 x 480	600 x 400
	● #811951/104 #811952/104	● #811951/156	⊗ #811961/109 #811961/155	⊗ #811969/109 #811969/155	● #812953/104	● #812953/156	● #813956/104	● #813958/104	⊗ #816952/112
福柯斯 70 	# 31730000	✓							
	# 31733000 # 31130000	✓	✓						
	# 31607000 # 31621000	✓		✓b1	✓b1	✓		✓	✓
福柯斯 100 	# 31517000	✓	✓	✓b1	✓b1	✓	✓	✓	✓
	福柯斯 190 	# 31608000			✓b1	✓b1	✓		✓
# 31518000				✓b1	✓b1	✓	✓	✓	✓a2
福柯斯 240 	# 31609000			✓b1	✓b1			✓	✓
	# 31519000			✓b1	✓b1			✓	✓





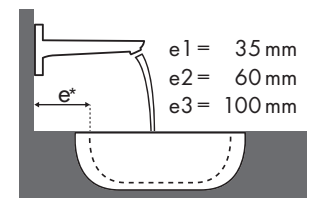
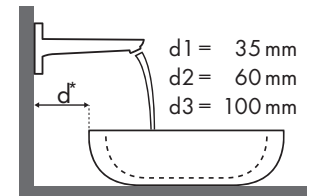
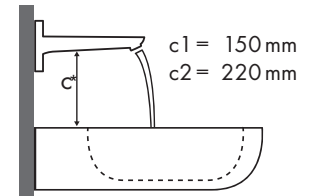
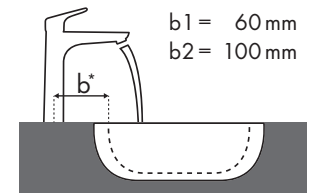
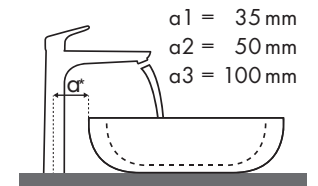











图例



✓ = 建议搭配 | ● = 穿过龙头安装孔 | ○ = 带龙头安装孔 | ⊗ = 没有龙头安装孔

哪款汉斯格雅龙头适合哪款面盆?

Roca

											
		Java 560 x 475	Selene 510 x 395	Meridian 850 x 460	Diverta 470 x 440	Diverta 750 x 440	Ibis 440 x 310	Victoria 560 x 460	Victoria 650 x 510	The Gap 600 x 470	The Gap 650 x 470
		●	⊗	●	●	●	○	●	●	●	●
		# 7327863000	# 7322307000	# 32724D0000	# 73271110	# 3271100000	# 3208410010	# 3253930000	# 3253910000	# 3274740000	# 3274730000
福柯斯 	# 31730000										
	# 31132000 # 31130000	✓					✓	✓			
福柯斯 100 	# 31607000 # 31621000	✓	✓ ^{a2}	✓	✓	✓	✓	✓	✓	✓	✓
	# 31517000	✓	✓ ^{a2}	✓	✓	✓	✓	✓	✓	✓	✓
福柯斯 190 	# 31608000	✓	✓ ^{a2}	✓	✓		✓	✓	✓	✓	✓
	# 31518000	✓	✓ ^{a2}	✓	✓		✓	✓	✓	✓	✓
福柯斯 240 	# 31609000	✓	✓ ^{a2}	✓				✓	✓	✓	✓
	# 31519000	✓	✓ ^{a2}	✓				✓	✓	✓	✓





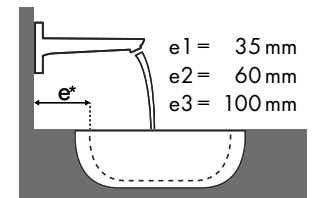
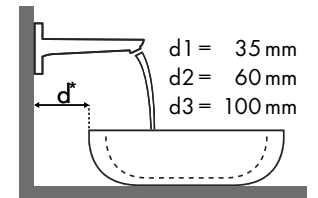
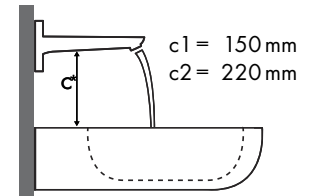
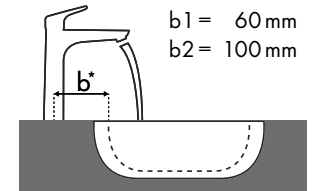
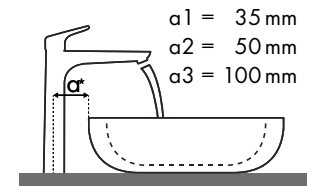



图例



✓ = 建议搭配 | ● = 穿过龙头安装孔 | ○ = 带龙头安装孔 | ⊗ = 没有龙头安装孔

哪款汉斯格雅龙头适合哪款面盆?

Villeroy & Boch

Memento									
		500 x 420		600 x 420		600 x 420		800 x 470	
		●	○	●	○	●	○	●	○
福柯斯 100 	# 31607000	●		●		●		●	
	# 31621000	○		○		○		○	
福柯斯 190 	# 31517000	○	○	○	○	○	○	○	○
	# 31608000	○		○		○		○	
	# 31518000	○	○	○	○	○	○	○	○
		●	●	●	●	●	●	●	●





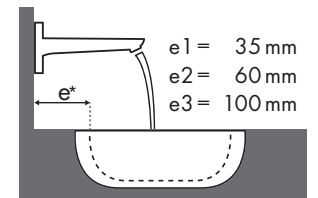
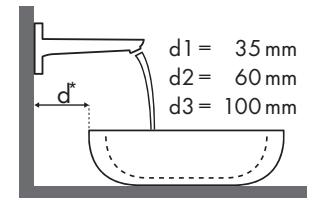
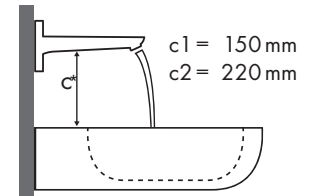
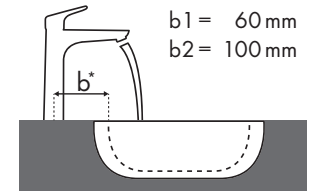
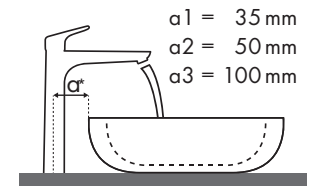



图例











✓ = 建议搭配 | ● = 穿过龙头安装孔 | ○ = 带龙头安装孔 | ⊗ = 没有龙头安装孔

哪款汉斯格雅龙头适合哪款面盆?

Villeroy & Boch

		Sentique				
						
		450 x 360	650 x 500	555 x 450		
		●	●	●	●	●
		# 5322 45 XX	# 5322 46 XX	# 5143 65 XX	# 5143 66 XX	# 5146 55 XX
福柯斯						
	福柯斯 70	# 31730000	✓			
		# 31733000	✓	✓		
		# 31130000	✓			
	福柯斯 100	# 31607000	✓		✓	✓
		# 31621000	✓			
		# 31517000	✓	✓	✓	✓
	福柯斯 190	# 31608000			✓	✓
		# 31518000			✓	✓
	福柯斯 240	# 31609000				✓
		# 31519000				✓

Villeroy & Boch

		Subway 2.0						
								
		450 x 370	500 x 400	600 x 470	650 x 490	630 x 355		
		●	●	●	●	●	●	
		# 7315 45 XX	# 7315 50 XX	# 7113 60 XX	# 7113 61 XX	# 7114 65 XX	# 7114 66 XX	# 4115 6R XX # 4115 6R XX
福柯斯								
	福柯斯 70	# 31730000	✓	✓				
		# 31733000	✓	✓				
		# 31130000	✓	✓				
	福柯斯 100	# 31607000	✓	✓	✓		✓	
		# 31621000	✓	✓			✓	
		# 31517000	✓	✓	✓	✓	✓	✓
	福柯斯 190	# 31608000			✓		✓	
		# 31518000			✓	✓	✓	
	福柯斯 240	# 31609000			✓			
		# 31519000			✓	✓		





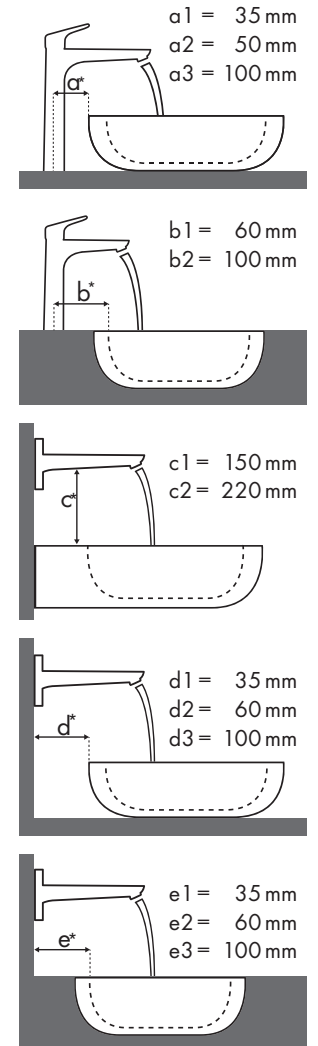





图例



哪款汉斯格雅龙头适合哪款面盆?

Villeroy & Boch

Loop & Friends													
		380 x 380		405 x 405		430 x 430		450 x 450		450 x 320		585 x 380	
		⊗	⊗	⊗	⊗	⊗	⊗	⊗	⊗	⊗	⊗	⊗	⊗
福柯斯		# 5149 00 XX	# 5149 01 XX	# 6156 10 XX	# 6156 11 XX	# 5144 00 XX	# 5144 01 XX	# 6140 45 XX	# 6141 45 XX	# 6155 00 XX	# 6155 01 XX	# 5151 00 XX	# 5151 01 XX
福柯斯 100 	# 31607000 # 31621000		✓a1			✓a1		✓a1		✓a1			
	# 31517000			✓a1			✓a1		✓a1		✓a1		
福柯斯 190 	# 31608000	✓a2	✓a2	✓a2	✓a2	✓a2	✓a2	✓a2	✓a2	✓a2	✓a2	✓a2	✓a2
	# 31518000		✓a2	✓a2	✓a2	✓a2	✓a2	✓a2	✓a2	✓a2	✓a2	✓a2	✓a2
福柯斯 240 	# 31609000		✓a2			✓a2		✓a2		✓a2			
	# 31519000			✓a2				✓a2		✓a2		✓a2	



图例

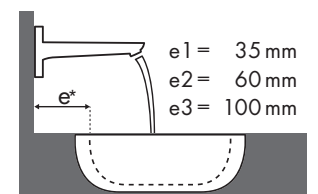
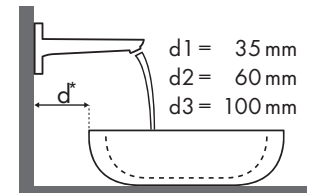
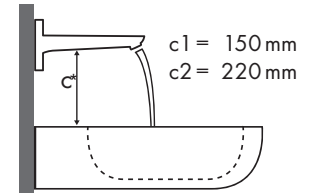
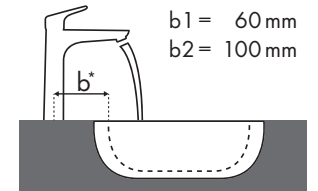
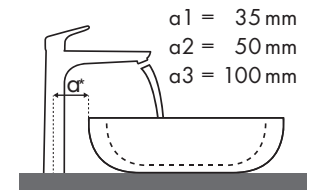

✓ = 建议搭配 | ● = 穿过龙头安装孔 | ○ = 带龙头安装孔 | ⊗ = 没有龙头安装孔