

Hansgrohe ComfortZone Test

Für jedes Waschbecken die passende Armatur. Für zufriedene Kunden.



Lästige Wasserspritzer und -flecken durch nicht aufeinander abgestimmte Armatur-Waschbecken-Kombinationen – diese Situation ist Ihnen sicher bekannt. Der damit verbundene Kundenärgernis gehört ab sofort der Vergangenheit an.



Mit dem **Hansgrohe ComfortZone Test**, einem eigens entwickelten, realitätsnahen Prüfverfahren hat Hansgrohe alle Armaturen der ComfortZone mit den gebräuchlichsten Waschbecken führender Hersteller getestet. Bei diesem Funktionstest zwischen Armatur und Waschbecken wird der Freiraum unter der Armatur sowie das Spritzverhalten geprüft. Ausführlichere Informationen zum ComfortZone Test finden Sie unter:

www.pro.hansgrohe.de/comfortzone-test

Keramiktypen

Zu den bekannten Waschbeckentypen finden Sie immer die passende Hansgrohe Armatur. Mit dem Hansgrohe ComfortZone Test erhalten Sie eine umfassende Beratungsunterlage für eine einwandfreie Montage von Waschtischarmatur und Waschbecken für ein komfortables und spritzfreies Händewaschen. Bei dem Hansgrohe ComfortZone Test wurden fünf unterschiedliche Keramiktypen getestet:

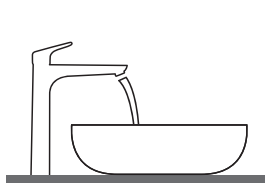

Die Waschschiessel mit Armatur dahinter

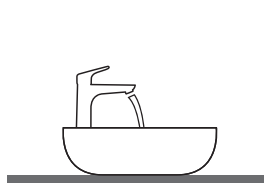

Die Waschschiessel mit Armatur darauf

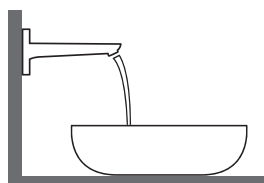

Die Waschschiessel mit Armatur an der Wand

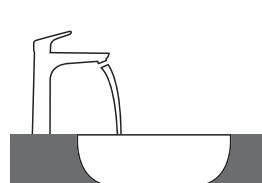

Das Unterbau- oder Aufsatzbecken mit freistehender Armatur

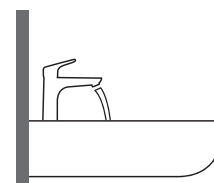

Das wandhängende Waschbecken mit Armatur darauf

Nutzen Sie jetzt kostenlos die Ergebnisse des ComfortZone Tests. Unter: www.pro.hansgrohe.de/comfortzone-test

Anwendungshinweise

Im Folgenden finden Sie die einfache Arbeitsweise mit den Ergebnissen des Hangrohe ComfortZone Tests.

Hangrohe ComfortZone Armatur mit Artikelnummer (unterschiedliche Artikelnummern bezeichnen verschiedene Varianten von Ablaufgarnituren)

Hersteller und Waschbeckenlinie

Waschbecken mit Artikelnummer und Größenangabe (unterschiedliche Artikelnummern bezeichnen verschiedene Hahnloch- und Überlaufvarianten)

Testergebnisse mit Duravit Waschbecken.pdf - Adobe Acrobat Pro

Erstellen | 12 / 14 | 99,2% | Suchen | Kommentar | Freigebe

hangrohe

Welche Hangrohe Armatur passt zu welchem Waschbecken?

Duravit	Vero	Waschbecken													
		250x450	500x250	485x315	595x465	550x465	850x490	1650x490	1250x490	600x470	800x470	1000x470	1200x470	500x380	600x380
Metris															
Metris 100		☉	☉	☉	☉	☉	☉	☉	☉	☉	☉	☉	☉	☉	☉
Metris 110		☉	☉	☉	☉	☉	☉	☉	☉	☉	☉	☉	☉	☉	☉
Metris 200		☉	☉	☉	☉	☉	☉	☉	☉	☉	☉	☉	☉	☉	☉
Metris 230		☉	☉	☉	☉	☉	☉	☉	☉	☉	☉	☉	☉	☉	☉
Metris 240		☉	☉	☉	☉	☉	☉	☉	☉	☉	☉	☉	☉	☉	☉
Metris 165mm		☉	☉	☉	☉	☉	☉	☉	☉	☉	☉	☉	☉	☉	☉
Metris 225mm		☉	☉	☉	☉	☉	☉	☉	☉	☉	☉	☉	☉	☉	☉

☑ = Kombination empfohlen | ☉ = Hahnloch durchgestochen | ○ = Hahnloch vorgestochen | ⊙ = ohne Hahnloch

Legende

Montagemaße für verschiedene Einbausituationen

Geprüfte, empfohlene Kombinationen

Erläuterungen Waschbeckentyp

Lesezeichen

- Einleitung
- Duravit 2nd Floor
- Duravit New Darling
- Duravit Starck 3
- Duravit Vero









Mit dem angelegten **Inhaltsverzeichnis** gelangen Sie einfach zur gewünschten Keramiklinie.

Suchen











Wenn Sie nach einer bestimmten Artikelnummer oder einem Produktamen von Armatur oder Waschbecken suchen, nutzen Sie das **Suchfeld** (Tastenkombination: Strg+f). So finden Sie schnell das gewünschte Produkt.

Welche Hansgrohe Armatur passt zu welchem Waschbecken?

Burgbad

Bel										
	610 x 355		1210 x 487		1610 x 487					
	●	○	●	○	●	○				
Talis	# MWAU061	# MWAU081	# MWAV121	# MWAV121*	# MWAV161	# MWAV161*	# MWAW071	# MWAW071*	# MWAW091	# MWAW091*
Talis 80 	# 32040000 # 32057000	✓	✓	✓	✓	✓	✓	✓	✓	✓
Talis 80 	# 32053000		✓	✓	✓	✓	✓	✓	✓	✓
Talis S² 	# 32070000 # 32073000	✓	✓	✓	✓	✓	✓	✓	✓	✓
Talis 210 	# 32084000		✓	✓	✓	✓	✓	✓	✓	✓
Talis 165 mm 	# 31618000	✓ ^{c1}					✓ ^{c1}		✓ ^{c1}	✓ ^{c1}
Talis 225 mm 	# 31611000		✓ ^{c1}	✓ ^{c1}	✓ ^{c1}	✓ ^{c1}	✓ ^{c1}	✓ ^{c1}	✓ ^{c1}	✓ ^{c1}

Burgbad

Cala														
	605 x 550		905 x 550		1205 x 550		1505 x 550							
	●	○	●	○	●	○	●	○						
Talis	# WTU060M	# WTU060M*	# WTU099M	# WTU096A	# WTU099M*	# WTU096A*	# WTU120M	# WTU122M	# WTU123A	# WTU120M*	# WTU122M*	# WTU123A*	# WTU150M	# WTU150M*
Talis 80 	# 32040000 # 32057000	✓										✓		
Talis 80 	# 32053000	✓	✓	✓	✓	✓	✓	✓	✓	✓	✓	✓	✓	
Talis 150 	# 32052000	✓	✓	✓	✓	✓	✓	✓	✓	✓	✓	✓	✓	
Talis S² 	# 32070000 # 32073000	✓	✓	✓	✓	✓	✓	✓	✓	✓	✓	✓	✓	
Talis 210 	# 32084000	✓	✓	✓	✓	✓	✓	✓	✓	✓	✓	✓	✓	
Talis 250 	# 32055000	✓	✓	✓	✓	✓	✓	✓	✓	✓	✓	✓	✓	
Talis 225mm 	# 31611000	✓ ^{c1}	✓ ^{c1}	✓ ^{c1}	✓ ^{c1}	✓ ^{c1}	✓ ^{c1}	✓ ^{c1}	✓ ^{c1}	✓ ^{c1}	✓ ^{c1}	✓ ^{c1}	✓ ^{c1}	



Legende

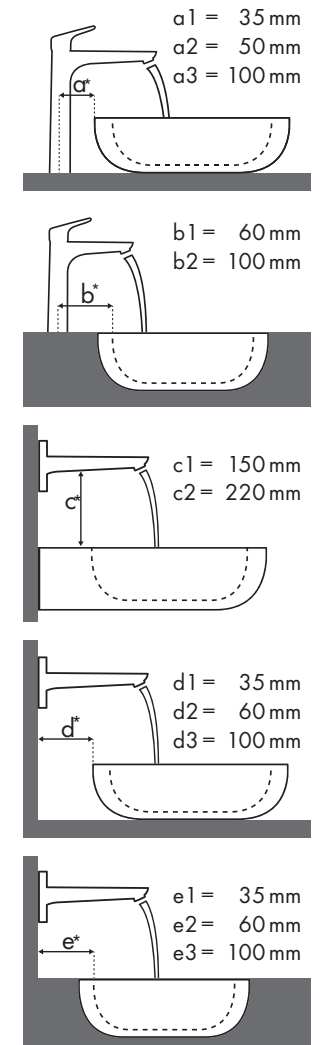









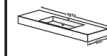
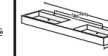

* = Waschbecken ohne Hahnloch auf Anfrage

✓ = Kombination empfohlen | ● = Hahnloch durchgestochen | ○ = Hahnloch vorgestochen | ⊗ = ohne Hahnloch

Welche Hansgrohe Armatur passt zu welchem Waschbecken?







Burgbad

Crono 1.0							
		810 x 500	1210 x 500	1610 x 500	2010 x 500		
		●	⊗	●	⊗	●	⊗
Talis		# MES8065	# MES8065*	# MES1265 # MES1266	# MES1265* # MES1266*	# MES1665 # MES1665*	# MDS2065 # MDS2065
Talis 80 	# 32040000 # 32057000	✓					✓
Talis 80 	# 32053000	✓	✓	✓	✓		
Talis 150 	# 32052000	✓	✓	✓	✓		
Talis S² 	# 32070000 # 32073000	✓	✓	✓	✓		
Talis 210 	# 32084000	✓	✓	✓	✓		
Talis 250 	# 32055000	✓	✓	✓	✓		
Talis 225 mm 	# 31611000		✓ ^{c1}	✓ ^{c1}	✓ ^{c1}		✓ ^{c1}

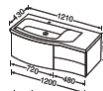
Burgbad

Max 1			
		710 x 385	906 x 506
		⊗	●
Talis		# KBAF070 # SELT070	# KBAC091 # SELR091 # KBAD091 # SELS091
Talis 80 	# 32040000 # 32057000		✓
Talis 80 	# 32053000		✓
Talis 150 	# 32052000		✓
Talis S² 	# 32070000 # 32073000		✓
Talis 210 	# 32084000		✓
Talis 250 	# 32055000	✓ ^{a2}	✓
Talis 165 mm 	# 31618000	✓ ^{c1} d2	

Burgbad

Sinea			
		1210 x 490	
		●	⊗
Talis		# WTU121E	# WTU121E*
Talis 80 	# 32040000 # 32057000	✓	
Talis 80 	# 32053000	✓	
Talis S² 	# 32070000 # 32073000	✓	
Talis 165 mm 	# 31618000		✓ ^{c1}
Talis 225 mm 	# 31611000		✓ ^{c1}



Legende

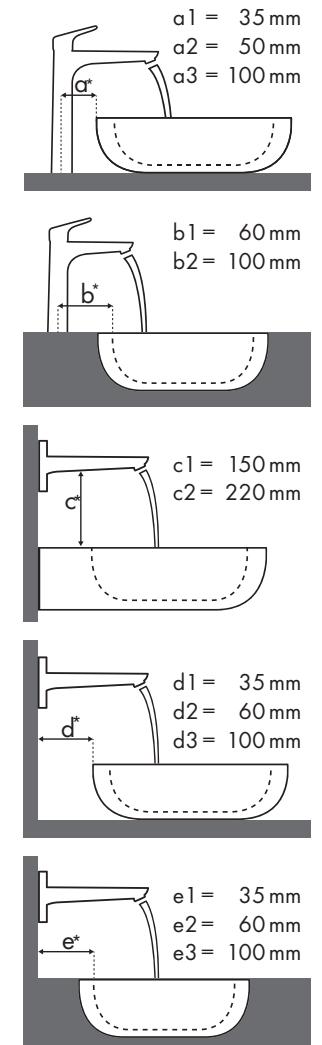

* = Waschbecken ohne Hahnloch auf Anfrage

✓ = Kombination empfohlen | ● = Hahnloch durchgestochen | ○ = Hahnloch vorgestochen | ⊗ = ohne Hahnloch

Welche Hansgrohe Armatur passt zu welchem Waschbecken?

Duravit

2nd Floor																		
		400 x 300		525 x 350		600 x 430		800 x 500		1200 x 505		580 x 415						
		●	⊗	⊗	●	⊗	●	⊗	●	⊗	●	⊗	●	⊗				
Talis		# 079040..00	# 079040..70	# 031653..00	# 049160..00	# 049160..27	# 049160..60	# 049160..28	# 049180..00	# 049180..27	# 049180..60	# 049180..28	# 049112..00	# 049112..27	# 049112..60	# 049112..28	# 031758..00	# 031758..29
Talis 80 	# 32040000				✓			✓		✓			✓					
	# 32057000																	
Talis 80 	# 32041000	✓			✓			✓		✓			✓					
	# 32130000																	
Talis 80 	# 32053000			✓b1	✓			✓		✓			✓					
Talis S² 	# 32070000			✓b1														
	# 32073000																	
Talis 210 	# 32084000			✓b1														
	# 32082000																	
	# 32080000																	
Talis 165 mm 	# 31618000		✓c1	✓c1	✓e2												✓d1	
Talis 225 mm 	# 31611000			✓c1	✓e2		✓c1	✓c1		✓c1			✓c1				✓d2	





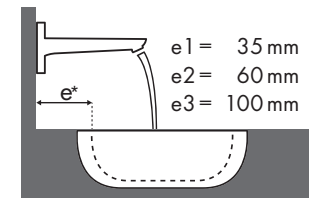
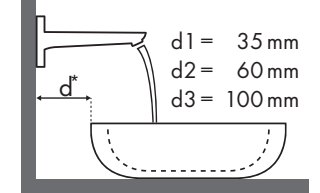
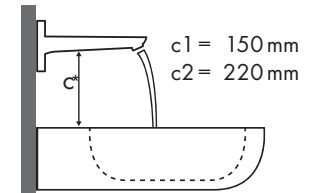
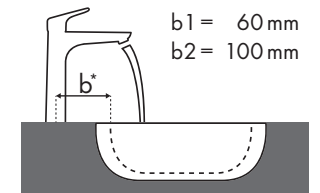
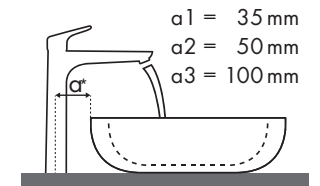









Legende



Welche Hansgrohe Armatur passt zu welchem Waschbecken?

Duravit

DuraStyle							
		450 x 335	550 x 440	370 x 370	430 x 430	600 x 380	1000 x 480
		●	●	⊗	⊗	⊗	●
		# 070845..00	# 231955..00	# 037337..00	# 034943..00	# 034960..00	# 232010..00
Talis 80 	# 32040000 # 32042000 # 32057000		✓	✓ ^{b1}			✓
	# 32041000 # 32130000	✓	✓	✓ ^{b1}			✓
Talis 80 	# 32053000			✓ ^{b1}			
Talis 150 	# 32052000			✓ ^{b2}			
Talis S² 	# 32070000 # 32073000		✓	✓ ^{b1}			✓
Talis 165 mm 	# 31618000			✓ ^{c1} e1	✓ ^{c1} d1	✓ ^{c1} d1	
Talis 225 mm 	# 31611000			✓ ^{c1} e2	✓ ^{c1} d2	✓ ^{c1} d3	





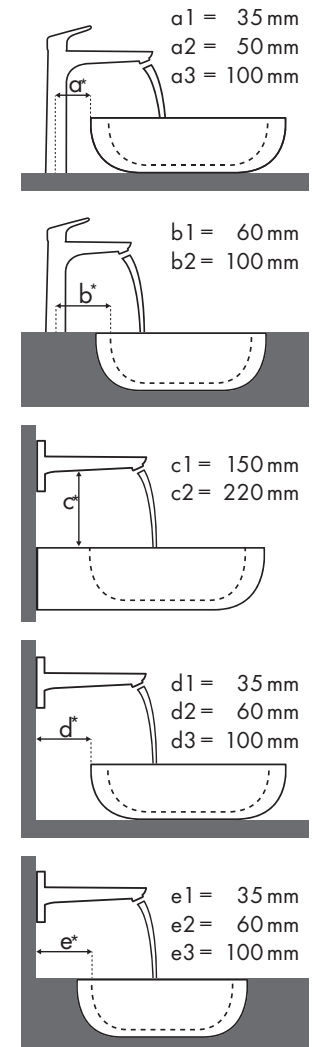









Legende



Welche Hansgrohe Armatur passt zu welchem Waschbecken?

Duravit

Happy D.2						
		500x360	600x500	600x400	600x460	1000x505
		●	●	⊗	⊗	●
Talis		# 070950..00	# 231660..00	# 231460..00	# 231560..00	# 231810..00
Talis 80 	# 32040000 # 32057000	✓	✓		✓	✓
	# 32041000 # 32130000	✓	✓		✓	✓
Talis 80 	# 32053000		✓			✓
Talis 150 	# 32052000					✓
Talis S² 	# 32070000 # 32073000	✓	✓		✓	✓
	Talis 210 	# 32084000				✓
	# 32082000 # 32080000				✓	✓
Talis 165 mm 	# 31618000			✓ ^{c1} _{d1}		
Talis 225 mm 	# 31611000			✓ ^{c1} _{d2}		





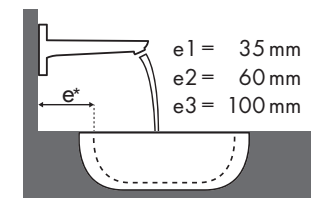
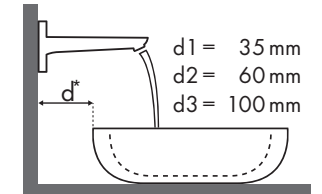
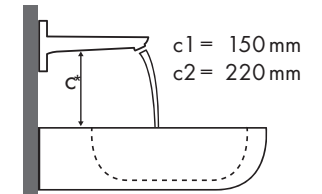
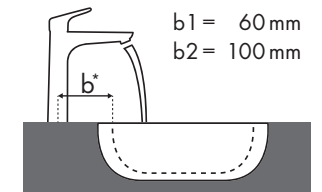
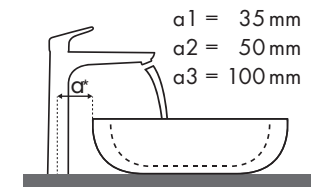







Legende



Welche Hansgrohe Armatur passt zu welchem Waschbecken?

Duravit

New Darling								
		470 x 345	600 x 520	650 x 540	470 x 470	830 x 545	1030 x 545	
		● # 073147..00	● # 262160..00	● # 262165..00	● # 049747..00	● # 049983..00	● # 049910..00	
Talis								
	# 32040000	✓	✓	✓	✓	✓	✓	
	# 32057000	✓	✓	✓	✓	✓	✓	
	# 32041000	✓	✓	✓	✓	✓	✓	
	# 32130000	✓	✓	✓	✓	✓	✓	
Talis 80								
	# 32053000		✓	✓	✓	✓	✓	
Talis 150								
	# 32052000		✓	✓	✓			
Talis S²								
	# 32070000 # 32073000		✓	✓	✓	✓	✓	
Talis 210								
	# 32084000 # 32082000 # 32080000		✓	✓	✓	✓	✓	



Legende

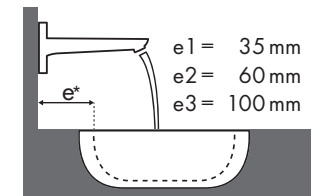
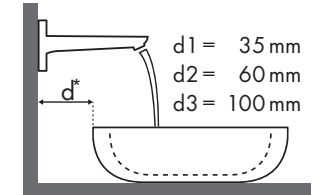
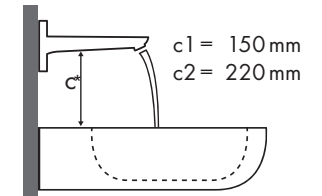
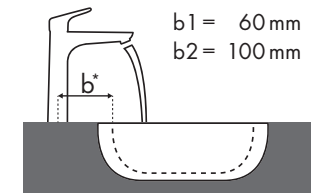
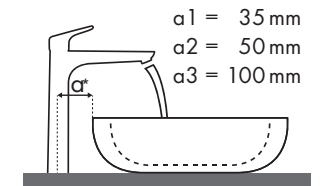

Welche Hansgrohe Armatur passt zu welchem Waschbecken?

Duravit

Vero																										
		250 x 450	500 x 250		485 x 315	595 x 465		550 x 465		850 x 490		1050 x 490		1250 x 490		600 x 470			800 x 470		1000 x 470		1200 x 470		500 x 380	600 x 380
Talis		●	●	○	⊗	●	⊗	●	⊗	●	⊗	●	⊗	●	⊗	●	⊗	●	⊗	●	⊗	●	⊗	●	⊗	
		#070225..00	#070350..08 #070350..09	#070350..00	#033048..00 #033048..22	#045260..00 #045260..60	#031555..00 #031555..60	#032985..00 #032985..60	#032910..00 #032910..60	#032912..00 #032912..60	#045460..00 #045460..27	#045460..60 #045460..28	#045460..41 #045460..70	#045480..00 #045480..27	#045480..60 #045480..28	#045410..27 #045410..28	#045412..00 #045412..60	#045550..00 #045560..00								
	#32040000 #32057000	✓	✓	✓	✓ ^{b1}	✓	✓	✓	✓	✓	✓	✓	✓	✓	✓	✓	✓	✓	✓	✓	✓	✓	✓	✓	✓	✓
	#32041000 #32130000	✓	✓	✓	✓ ^{b1}	✓	✓	✓	✓	✓	✓	✓	✓	✓	✓	✓	✓	✓	✓	✓	✓	✓	✓	✓	✓	✓
	#32053000	✓	✓	✓	✓ ^{b1}	✓	✓	✓	✓	✓	✓	✓	✓	✓	✓	✓	✓	✓	✓	✓	✓	✓	✓	✓	✓	✓
	#32052000				✓ ^{b2}	✓	✓	✓	✓	✓	✓	✓	✓	✓	✓	✓	✓	✓	✓	✓	✓	✓	✓	✓	✓	✓
	#32070000 #32073000				✓ ^{b1}	✓	✓	✓	✓	✓	✓	✓	✓	✓	✓	✓	✓	✓	✓	✓	✓	✓	✓	✓	✓	✓
	#32080000 #32084000 #32084000 #32082000 #32080000					✓	✓	✓	✓	✓	✓	✓	✓	✓	✓	✓	✓	✓	✓	✓	✓	✓	✓	✓	✓	✓
	#32055000																				✓	✓				
	#31618000				✓ ^{c1} _{e2}	✓ ^{c1}	✓ ^{c1}	✓ ^{c1}	✓ ^{c1}	✓ ^{c1}	✓ ^{c1}	✓ ^{c1}	✓ ^{c1}	✓ ^{c1}	✓ ^{c1}	✓ ^{c1}	✓ ^{c1}	✓ ^{c1}	✓ ^{c1}	✓ ^{c1}	✓ ^{c1}	✓ ^{c1}	✓ ^{c1}	✓ ^{c1}	✓ ^{c1}	✓ ^{c1}
	#31611000				✓ ^{c1} _{e3}	✓ ^{c1}	✓ ^{c1}	✓ ^{c1}	✓ ^{c1}	✓ ^{c1}	✓ ^{c1}	✓ ^{c1}	✓ ^{c1}	✓ ^{c1}	✓ ^{c1}	✓ ^{c1}	✓ ^{c1}	✓ ^{c1}	✓ ^{c1}	✓ ^{c1}	✓ ^{c1}	✓ ^{c1}	✓ ^{c1}	✓ ^{c1}	✓ ^{c1}	✓ ^{c1}





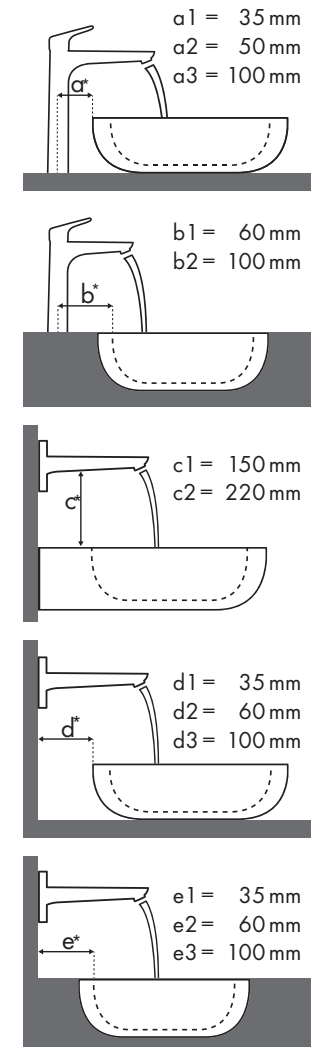





Legende



✓ = Kombination empfohlen | ● = Hahnloch durchgestochen | ○ = Hahnloch vorgestochen | ⊗ = ohne Hahnloch

Welche Hansgrohe Armatur passt zu welchem Waschbecken?

Gala

						
		600 x 450	600 x 475	800 x 475	800 x 475	800 x 475
		●	●	●	●	●
		# 2701001..00	# 1302001..00	# 1301001..00	# 2605001..00	# 2604001..00
Talis 80 	# 32040000 # 32042000 # 32057000				✓	✓
	# 32041000 # 32130000		✓	✓	✓	✓
Talis 80 	# 32053000				✓	✓
Talis S 	# 32070000 # 32073000	✓			✓	✓
	Talis 210 	# 32084000 # 32082000 # 32080000	✓ ✓	✓ ✓	✓ ✓	✓ ✓





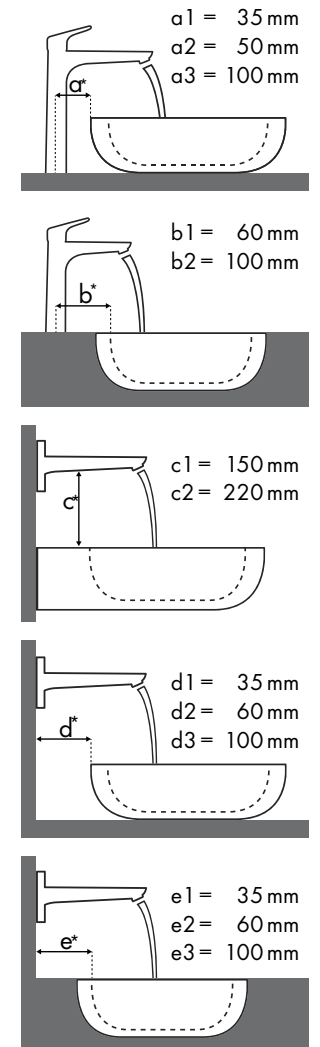





Legende













Welche Hansgrohe Armatur passt zu welchem Waschbecken?

Ideal Standard

Moments				
		500 x 375	650 x 515	900 x 515
		●	●	●
Talis		# K0718 xx	# K0717 xx	# K0715 xx
Talis 80 	# 32040000 # 32057000	✓	✓	✓
Talis 80 	# 32053000		✓	✓
Talis 150 	# 32052000		✓	✓
Talis S² 	# 32070000 # 32073000		✓	✓
Talis 210 	# 32084000		✓	✓
Talis 250 	# 32055000			✓

Ideal Standard

SimplyU						
		500 x 500	500 x 650	550 x 350		
		●	○	●	○	⊗
Talis		# T0997 xx	# T0127 xx	# T0156 xx	# T0129 xx	# T0126 xx
Talis 80 	# 32040000 # 32057000	✓	✓	✓	✓	
Talis 80 	# 32053000	✓	✓	✓	✓	
Talis 150 	# 32052000	✓	✓	✓	✓	
Talis S² 	# 32070000 # 32073000			✓	✓	
Talis 210 	# 32084000			✓	✓	
Talis 165 mm 	# 31618000			✓ ^{c1}	✓ ^{c1} _{d1}	
Talis 225 mm 	# 31611000			✓ ^{c1}	✓ ^{c1} _{d3}	



Legende

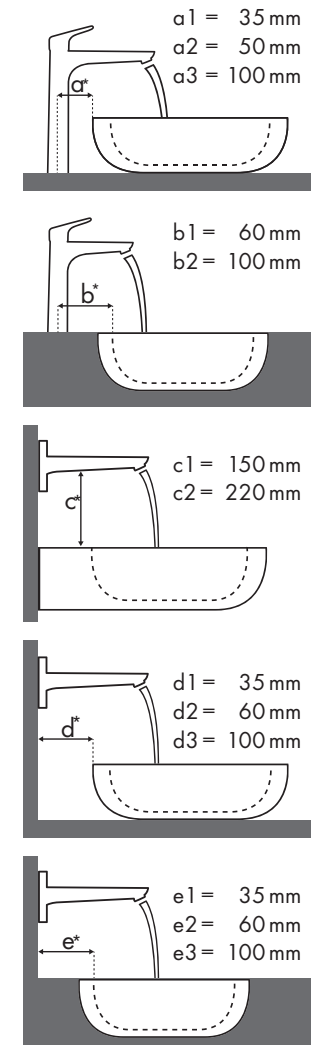

Welche Hansgrohe Armatur passt zu welchem Waschbecken?

Keramag

iCon		500 x 485			600 x 485		750 x 485		900 x 485	
		●		●	⊗	●	●		⊗	
		# 124050	# 124150	# 124060	# 124063	# 124075	# 124090	# 124190	# 124195	# 124093
Talis										
Talis 80	# 32040000 # 32057000	✓	✓		✓	✓				
	# 32041000 # 32130000	✓	✓		✓	✓				
Talis 80	# 32053000	✓	✓		✓	✓				
Talis 150	# 32052000		✓		✓	✓				
Talis S²	# 32070000 # 32073000		✓		✓	✓				
Talis 210	# 32084000 # 32082000 # 32080000		✓		✓	✓				
Talis 165 mm	# 31618000			✓ c1					✓ c1	
Talis 225 mm	# 31611000			✓ c1					✓ c1	

Keramag

Silk		400 x 295		600 x 470		570 x 427		1000 x 470	
		●		●	●		●		⊗
		# 121640	# 121660	# 121650	# 121655	# 121600	# 121625		
Talis									
Talis 80	# 32040000 # 32057000		✓			✓			
	# 32041000 # 32130000	✓	✓	✓	✓	✓	✓		
Talis 80	# 32053000		✓					✓	
Talis 150	# 32052000		✓						
Talis S²	# 32070000 # 32073000							✓	
Talis 210	# 32084000 # 32082000 # 32080000							✓	
Talis 165 mm	# 31618000								✓ c1
Talis 225 mm	# 31611000								✓ c1



Legende

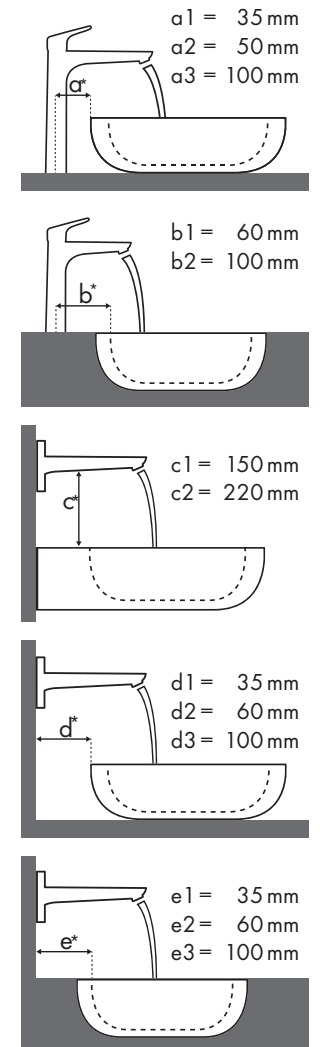

Welche Hansgrohe Armatur passt zu welchem Waschbecken?

Keramik



Renova Nr. 1 Plan																				
		400 x 250		600 x 480		650 x 480		750 x 480	600 x 480		650 x 480		850 x 480		1000 x 480					
Talis		●	●	●	●	●	●	○	⊗	●	●	●	●	○	○	●	●			
		# 272140	# 272142	# 222260	# 222262	# 222265	# 222267	# 222268	# 222266	# 122175 # 122180	# 225160	# 225165	# 125185	# 125100	# 122185	# 122187	# 122188	# 122186	# 122100	# 122102
	# 32040000 # 32057000	✓		✓		✓				✓	✓	✓	✓	✓	✓			✓		
	# 32041000 # 32130000	✓	✓	✓	✓	✓	✓			✓	✓	✓	✓	✓	✓			✓	✓	
	# 32053000			✓		✓				✓	✓	✓	✓	✓				✓		
	# 32052000					✓				✓	✓	✓	✓	✓				✓	✓	
	# 32070000 # 32073000			✓		✓				✓	✓	✓	✓	✓				✓	✓	
	# 32084000 # 32082000 # 32080000			✓		✓				✓	✓	✓	✓	✓				✓	✓	
	# 32055000					✓						✓	✓	✓	✓			✓	✓	
	# 31618000							✓ ^{c1}	✓ ^{c1}							✓ ^{c1}	✓ ^{c1}			
	# 31611000							✓ ^{c1}	✓ ^{c1}							✓ ^{c1}	✓ ^{c1}			



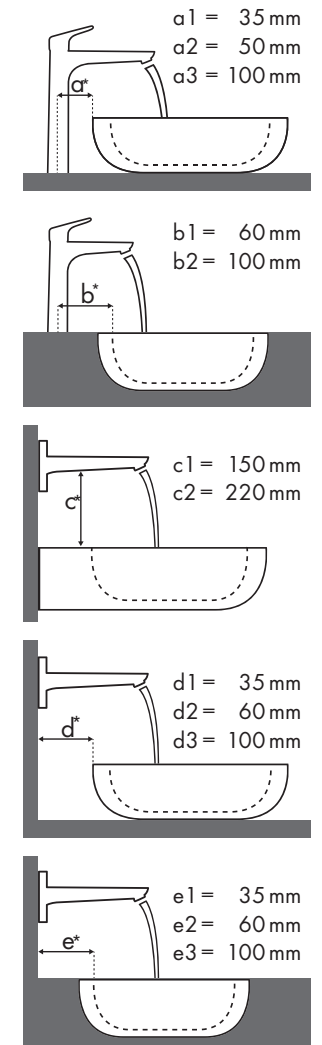





Legende













✓ = Kombination empfohlen | ● = Hahnloch durchgestochen | ○ = Hahnloch vorgestochen | ⊗ = ohne Hahnloch

Welche Hansgrohe Armatur passt zu welchem Waschbecken?

Keromag

		Xeno						
								
		420 x 230	600 x 475	600 x 475	1200 x 475	1200 x 475		
		●	●	●	●	●	⊗	●
		# 126240	# 126245	# 126260	# 126560	# 126220	# 126221	# 126225
Talis								
Talis 80		# 32041000 # 32130000	✓	✓	✓	✓	✓	✓
Talis 210		# 32082000 # 32080000		✓	✓	✓		✓
Talis 165 mm		# 31618000					✓ c1	
Talis 225 mm		# 31611000					✓ c1	

Keromag

		My Day					
							
		400 x 280	650 x 480	800 x 480	1000 x 480	600 x 400	
		●	●	●	●	●	●
		# 125540	# 125440	# 125465	# 125480	# 125400	# 245460
Talis							
Talis 80		# 32040000 # 32057000	✓	✓		✓	✓
		# 32041000 # 32130000	✓	✓		✓	✓
Talis 80		# 32053000		✓	✓	✓	
Talis 150		# 32052000					✓ a2
Talis S		# 32070000 # 32073000		✓	✓	✓	
Talis 165 mm		# 31618000					✓ c1 d2
Talis 225 mm		# 31611000					✓ c1 d3



Legende

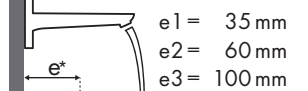
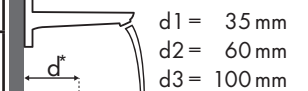
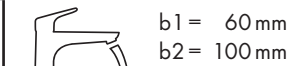
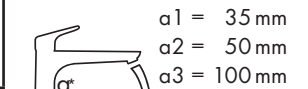

Welche Hansgrohe Armatur passt zu welchem Waschbecken?

Laufen

My Life									
		470 x 380		750 x 480		750 x 530		650 x 440	
		●	⊗	●	⊗	●	⊗	●	⊗
Talis		#815942/104	#815942/109	#811946/104	#811946/109	#810946/104	#810946/109	#818944/104	#818944/109
Talis 80 	#32040000 #32057000	✓		✓		✓		✓	
Talis 80 	#32053000			✓		✓		✓	
Talis 150 	#32052000					✓			
Talis S² 	#32070000 #32073000			✓		✓		✓	
Talis 210 	#32084000			✓		✓		✓	
Talis 250 	#32055000					✓			
Talis 165 mm 	#31618000		✓ ^{c1}						✓ ^{c1} _{d1}
Talis 225 mm 	#31611000		✓ ^{c1}	✓ ^{c1} _{d1}		✓ ^{c1}		✓ ^{c1}	✓ ^{c1} _{d2}

✓ = Kombination empfohlen | ● = Hahnloch durchgestochen | ○ = Hahnloch vorgestochen | ⊗ = ohne Hahnloch





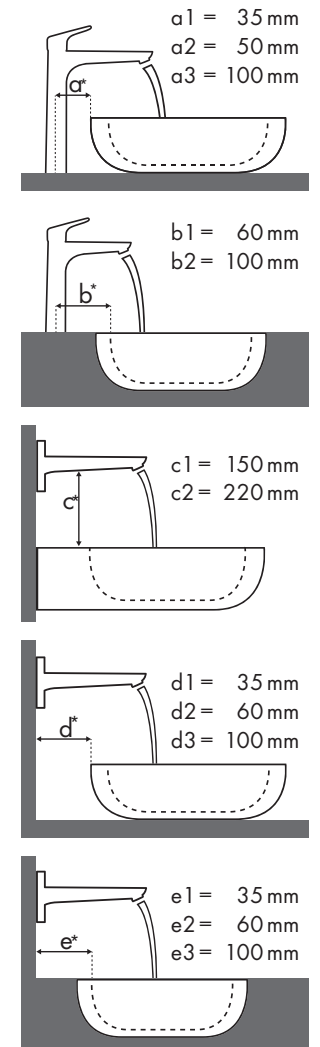





Legende



Welche Hansgrohe Armatur passt zu welchem Waschbecken?

Laufen

Pro		450 x 340		525 x 400		625 x 400		600 x 380				850 x 480		1050 x 480		600 x 400				
		●		●		⊗		●		●		●		●		⊗				
		#811951/104	#811952/104	#811951/156	#811951/109	#811952/109	#811951/142	#811961/109	#811961/155	#811969/109	#811969/155	#812953/104	#812953/156	#812953/109	#812953/142	#813956/104	#813956/109	#813958/104	#813958/109	#816952/112
Talis																				
Talis 80 	#32040000 #32057000	✓								✓					✓		✓			
	#32041000 #32130000	✓	✓							✓	✓				✓		✓			
Talis 80 	#32053000									✓					✓		✓			
Talis 150 	#32052000					✓ _{b1}	✓ _{b1}								✓		✓			
Talis S² 	#32070000 #32073000					✓ _{b1}	✓ _{b1}			✓					✓		✓			
Talis 210 	#32084000 #32082000 #32080000					✓ _{b1}	✓ _{b1}			✓					✓		✓			
Talis 250 	#32055000					✓ _{b1}	✓ _{b1}								✓		✓			
Talis 165 mm 	#31618000			✓ _{c1}	✓ _{c1}	✓ _{e2} ^{c1}	✓ _{e2} ^{c1}					✓ _{c1}	✓ _{c1}						✓ _{d2} ^{c1}	
Talis 225 mm 	#31611000					✓ _{e2} ^{c1}	✓ _{e2} ^{c1}					✓ _{c1}	✓ _{c1}		✓ _{c1}		✓ _{c1}		✓ _{d2} ^{c1}	

✓ = Kombination empfohlen | ● = Hahnloch durchgestochen | ○ = Hahnloch vorgestochen | ⊗ = ohne Hahnloch





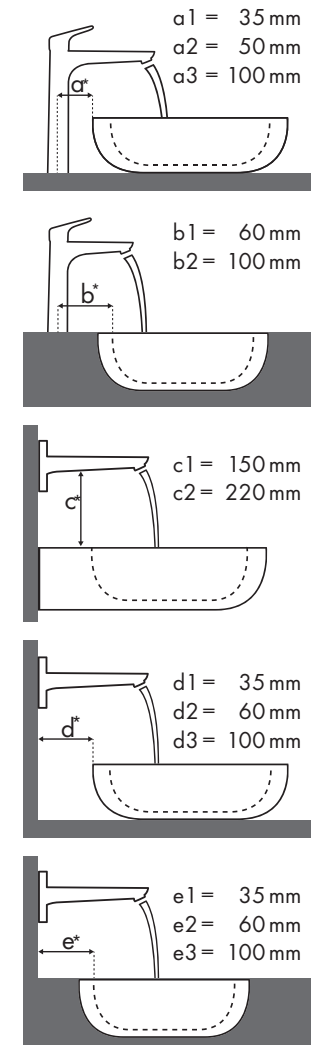















Legende



Welche Hansgrohe Armatur passt zu welchem Waschbecken?

Roca

											
		Java 560 x 475	Selene 510 x 395	Meridian 850 x 460	Diverta 470 x 440	Diverta 750 x 440	Ibis 440 x 310	Victoria 560 x 460	Victoria 650 x 510	The Gap 600 x 470	The Gap 650 x 470
Talis		● # 7327863000	⊗ # 7322307000	● # 32724D0000	● # 73271110	● # 3271100000	○ # 3208410010	● # 3253930000	● # 3253910000	● # 3274740000	● # 3274730000
Talis 80 	# 32040000 # 32042000 # 32057000	✓		✓	✓	✓	✓	✓	✓	✓	✓
	# 32041000 # 32130000	✓		✓	✓	✓	✓	✓	✓	✓	✓
Talis 80 	# 32053000	✓						✓	✓		
Talis 150 	# 32052000		✓ ^{a2}								
Talis S 	# 32070000 # 32073000	✓	✓ ^{a2}	✓		✓		✓	✓	✓	✓
Talis 210 	# 32084000	✓	✓ ^{a2}	✓				✓	✓	✓	✓
	# 32082000 # 32080000		✓ ^{a2}	✓				✓	✓	✓	✓
Talis 250 	# 32055000		✓ ^{a2}								
Talis 165mm 	# 31086000		✓ ^{c1} d2					✓ ^{c1}			
Talis 225mm 	# 31611000		✓ ^{c1} d2								

✓ = Kombination empfohlen | ● = Hahnloch durchgestochen | ○ = Hahnloch vorgestochen | ⊗ = ohne Hahnloch





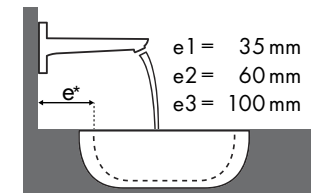
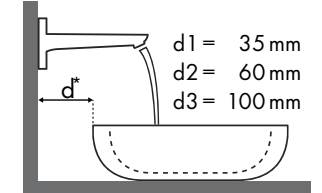
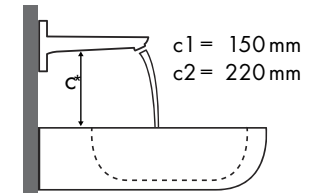
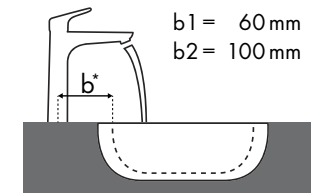
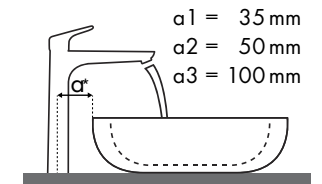





Legende



Welche Hansgrohe Armatur passt zu welchem Waschbecken?

Villeroy & Boch

Memento														
		400 x 260	500 x 420				600 x 420				800 x 470			
		● # 5333 41 XX ● # 5333 4G XX	● # 5133 50 XX ● # 5133 5L XX	● # 5133 51 XX ● # 5133 5G XX	⊗ # 5133 52 XX ⊗ # 5133 5J XX	⊗ # 5133 53 XX ⊗ # 5133 5F XX	● # 5133 60 XX ● # 5133 6L XX	● # 5133 61 XX ● # 5133 6G XX	⊗ # 5133 62 XX ⊗ # 5133 6J XX	⊗ # 5133 63 XX ⊗ # 5133 6F XX	● # 5135 60 XX ● # 5135 61 XX	⊗ # 5135 62 XX ⊗ # 5135 63 XX	● # 5133 85 XX ● # 5133 81 XX	⊗ # 5133 86 XX ⊗ # 5133 83 XX
Talis														
	# 32040000 # 32057000 # 32041000 # 32130000		✓			✓				✓		✓		
Talis 80														
	# 32053000		✓			✓				✓		✓		
Talis S														
	# 32070000 # 32073000		✓			✓				✓		✓		
Talis 210														
	# 32084000 # 32082000 # 32080000											✓		
Talis 225 mm														
	# 31611000			✓ ^{c1}	✓ ^{c1}		✓ ^{c1}	✓ ^{c1}		✓ ^{c1}	✓ ^{c1}		✓ ^{c1}	





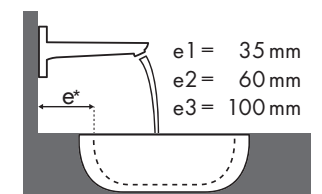
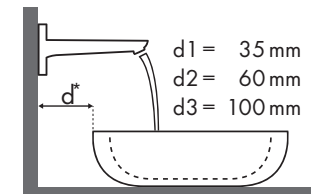
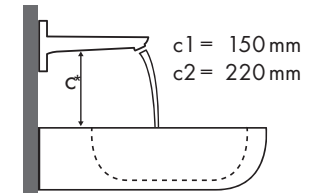
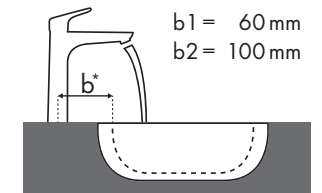
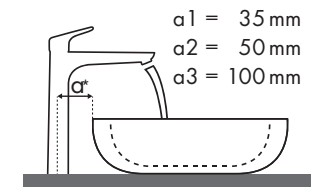





Legende











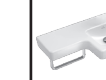

Welche Hansgrohe Armatur passt zu welchem Waschbecken?

Villeroy & Boch

Sentique							
		450 x 360		650 x 500		555 x 450	
		●	●	●	●	●	
		# 5322 45 XX	# 5322 46 XX	# 5143 65 XX	# 5143 66 XX	# 5146 55 XX	
Talis							
	# 32040000 # 32057000	✓		✓		✓	
	# 32041000 # 32130000	✓	✓	✓	✓	✓	
Talis 80							
	# 32053000			✓		✓	
Talis 150							
	# 32052000			✓			
Talis S							
	# 32070000 # 32073000			✓		✓	
Talis 210							
	# 32084000 # 32082000 # 32080000			✓			

Villeroy & Boch

Subway 2.0										
		450 x 370		500 x 400	600 x 470		650 x 490	630 x 355		
		●	●	●	●	○	●	●	●	●
		# 7315 45 XX	# 7315 50 XX	# 7113 60 XX	# 7113 61 XX	# 7113 62 XX ⊗	# 7114 65 XX	# 7114 66 XX	# 7114 67 XX ⊗	# 4115 6R XX # 4115 6R XX
Talis										
Talis 80										
	# 32040000 # 32057000	✓	✓	✓			✓			
	# 32041000 # 32130000	✓	✓	✓	✓		✓	✓		✓
Talis 80										
	# 32053000			✓			✓			
Talis S										
	# 32070000 # 32073000			✓			✓			
Talis 210										
	# 32084000 # 32082000 # 32080000			✓			✓			
Talis 165 mm										
	# 31618000							✓ ^{c1}		
Talis 225 mm										
	# 31611000				✓ ^{c1}			✓ ^{c1}		





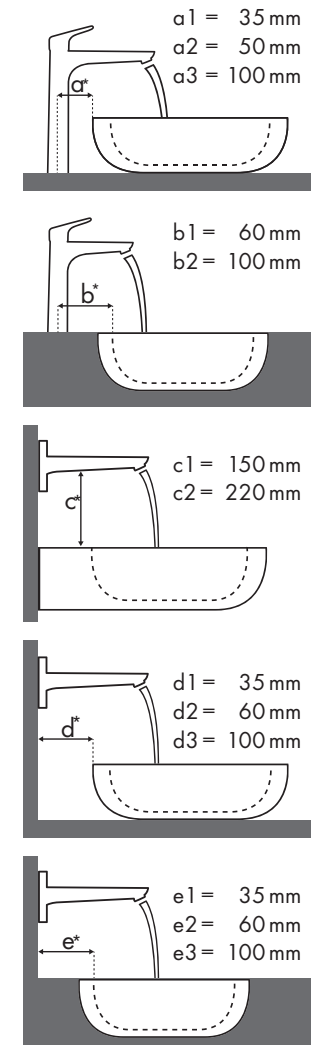









Legende



Welche Hansgrohe Armatur passt zu welchem Waschbecken?

Villeroy & Boch

Loop & Friends													
		380 x 380		405 x 405		430 x 430		450 x 450		450 x 320		585 x 380	
		⊗	⊗	⊗	⊗	⊗	⊗	⊗	⊗	⊗	⊗	⊗	⊗
Talis		# 5149 00 XX	# 5149 01 XX	# 6156 10 XX	# 6156 11 XX	# 5144 00 XX	# 5144 01 XX	# 6140 45 XX	# 6141 45 XX	# 6155 00 XX	# 6155 01 XX	# 5151 00 XX	# 5151 01 XX
Talis 150 	# 32052000			✓a2				✓a2					
Talis S 	# 32070000 # 32073000			✓a2				✓a2		✓a2			
Talis 210 	# 32084000 # 32082000 # 32080000			✓a2				✓a2		✓a2			
Talis 250 	# 32055000			✓a2				✓a2					
Talis 165 mm 	# 31618000	✓c1 d2	✓c1 d2	✓c1 d2	✓c1 d2	✓c1 d2	✓c1 d2	✓c1 d2	✓c1 d2	✓c1 d2	✓c1 d2		
Talis 225 mm 	# 31611000	✓c1 d3	✓c1 d3	✓c1 d3	✓c1 d3	✓c1 d3	✓c1 d3	✓c1 d2	✓c1 d2	✓c1 d2	✓c1 d2	✓c1 d2	✓c1 d2



Legende

